

CHAMPIONSHIP EDITION

RC10

2nd PLACE
WORLD CHAMPION



INSTRUCTION MANUAL

The New RC10's

NEW IDLER GEARS

NEW DUST COVER

**NEW TURNBUCKLES,
FRONT AND REAR**

NEW LOW PROFILE REAR WHEELS

NEW LOW PROFILE REAR TIRES

**NEW INLINE FRONT AXLE
AND STEERING BLOCKS**

Advanced, Competition

Latest Technology

NEW REAR HUB CARRIERS

NEW FRONT SHOCK TOWER

NEW SHOCK MOUNTING POSITIONS

NEW LONGER FRONT SHOCKS

NEW LONGER FRONT A-ARMS

NEW LOW PROFILE FRONT TIRES

NEW LOW PROFILE FRONT WHEELS

© 1990 ASSOCIATED ELECTRICS, INC.

Version of the RC10

CAUTION

Ni-cad batteries are susceptible to damage when overcharged at a high rate, and can release caustic chemicals if the overcharge is severe. Read the battery charging instructions in this manual before attempting to run your car.

Do not stall the motor under power. If the car stops suddenly on the track, or fails to move forward when you attempt to accelerate, push the throttle control on your transmitter to the brake position immediately and attend to the car. A small rock can stall the gears, and if the throttle is left in the on position the result can be a burned out motor or resistor (or electronic speed control unit).

If you run your car to the point where more than one cell in the pack is completely discharged, it is possible to lose radio control of the car before the drive motor stops completely. For this reason you should not operate your car in an area where it could be harmed or cause harm, such as near a busy roadway or a pool of water. Usually radio control will be regained as soon as you pick up the car and the motor is allowed to free-run. If you still don't have control, then you should unplug the motor.

When you stop running your car, turn off the radio at the car first (with the resistor in the off position) before turning off the transmitter.

Be sure that the resistor is in the off position while you are charging the battery.

A burned-out or shorted motor can make the car appear to have radio problems. If the car slows down suddenly and the radio acts erratically even with a full battery charge, then the cause is probably the motor. Check the range of the radio with the motor unplugged. A shorted motor will draw extremely high current even under no-load conditions.

WARNING

The use of Ni-cad packs with two-pin connectors, designed for aftermarket or for other brands of cars, can be hazardous. Some of these packs can be plugged into the three-pin connector on the RC10 in a variety of incorrect ways that can burn out your radio equipment and wire harness. ALL ASSOCIATED packs for the RC10 have three-pin connectors that can be inserted one way only.

FIRST, A WORD

Your new competition edition RC10 car is the latest state-of-the-art, 2WD off-road racer in the world. There is none better.

Our original RC10 car has won more IFMAR World Championships and ROAR Nationals combined than all the other 2WD off-road winning cars put together. It is by far the most popular 2WD off-road RACE car in the world. The READERS of RC CAR ACTION magazine voted the RC10 as CAR OF THE YEAR by a 6 to 1 margin over the 2nd place car! The racers know which car is best.

As great as the original RC10 is, we wanted something better, and we know you did too, so we've brought out the new RC10. At first glance it looks like a regular RC10. But it's much more than that. It has NEW, longer front A-arms with two NEW shock mounting positions. NEW inline front axle and steering blocks which greatly improve the steering. NEW front shock towers which give more ideal shock mounting positions. NEW rear hub carriers with more toe-in for greater stability. NEW turnbuckles for easier adjustments. NEW idler gears which are strong enough even for monster trucks. NEW low profile front and rear wheels and tires, giving more steering in the front end and more traction in the rear end. Which all adds up to give you the best 2WD car in the world.

You'll find the photos in the instructions so easy to follow that you may be tempted to put the car together from the photos alone. However, although you have the best car kit, if you want the best COMPLETED model race car, then you will want to put it together correctly--by following these instructions. All that's required is to read the few lines of text near each photo.

DON'T OPEN ANY OF THE PARTS BAGS UNTIL THESE INSTRUCTIONS TELL YOU, otherwise you'll get the parts mixed up and then you will have trouble assembling your car.

While you are building the car you will sometimes be working with several parts bags at the same time. These bags are referred to by number in the instructions, and you will find a number label on each of the main parts bags. There are also more bags inside the main parts bags; these are not numbered and belong to the bag they came out of. See pages 54-56 for the list of parts and bags in your kit.

Bags and parts will start multiplying like rabbits as you build, so try to keep the bags separate. One good way is to use large paper plates (picnic plates with partitions are best). Mark the plates with bag numbers and dump the parts into them. When the parts are used up, relabel the plate for another bag. It's much easier to find the part you need if it's spread out where you can see it.

TOOLS. The kit contains the shock wrench and all the Allen wrenches you'll need, but you will have to supply the following:

#2 Phillips screwdriver (Associated #SP76)
A needle-nose pliers
A hobby knife, such as an X-acto with a pointed blade.

A soldering iron (25 to 50 watts), and a small amount of ROSIN (not acid) core 60/40 solder.

The kit can be assembled even easier if you have the following:

3/32" straight Allen wrench with handle. Will make installing the Allen screws much faster and easier (Associated #SP73)

A ruler with decimal inches or metric measure
A 3/16" nut driver will make installing the ball ends easier (Associated #SP86)

A 1/4" nut driver will speed up installing the 1/4" nuts (#SP85)

Socket or open-end wrench

Small screwdriver

Thread-locking compound

ZAP or Hot Stuff (cyanoacrylate adhesive)

Vise

File

Drill with #43 (2.3MM) bit

WARNING! Do not use a power screwdriver. They spin too fast, causing screws to heat up when being driven into plastic and will strip out.

Take your time assembling the car. It's not a race to see how fast you put the car together; it's how well you put it together that determines how fast you'll be able to race.

Boxes at each step are provided so you can put a checkmark for each assembly after each step is completed. So when you stop during assembly time, you'll be able to come back and start in the correct step.

One final note for you experienced, new builders and racers: **please build the car our way first!!** The RC10 is a remarkably fast car right out of the box. There's a reason for everything on the car, and very few compromises were made in its design. Work with the car first and see what it can do before you experiment or make changes.

Clear off your workbench, line up some paper plates, grab a sandwich, and let's begin...

Fig. 1 We'll start with Fig. 1. Only take the parts out of the bag that we tell you, and no others. Look for bag #6-4 and take the #6310 gold anodized nose piece out of the bag, as shown in the photo and the shortest Phillips flat head screw, as shown. DO NOT take anything else out of the bag. Now take the 2 Phillips screws out of bag #6-2, but nothing else.

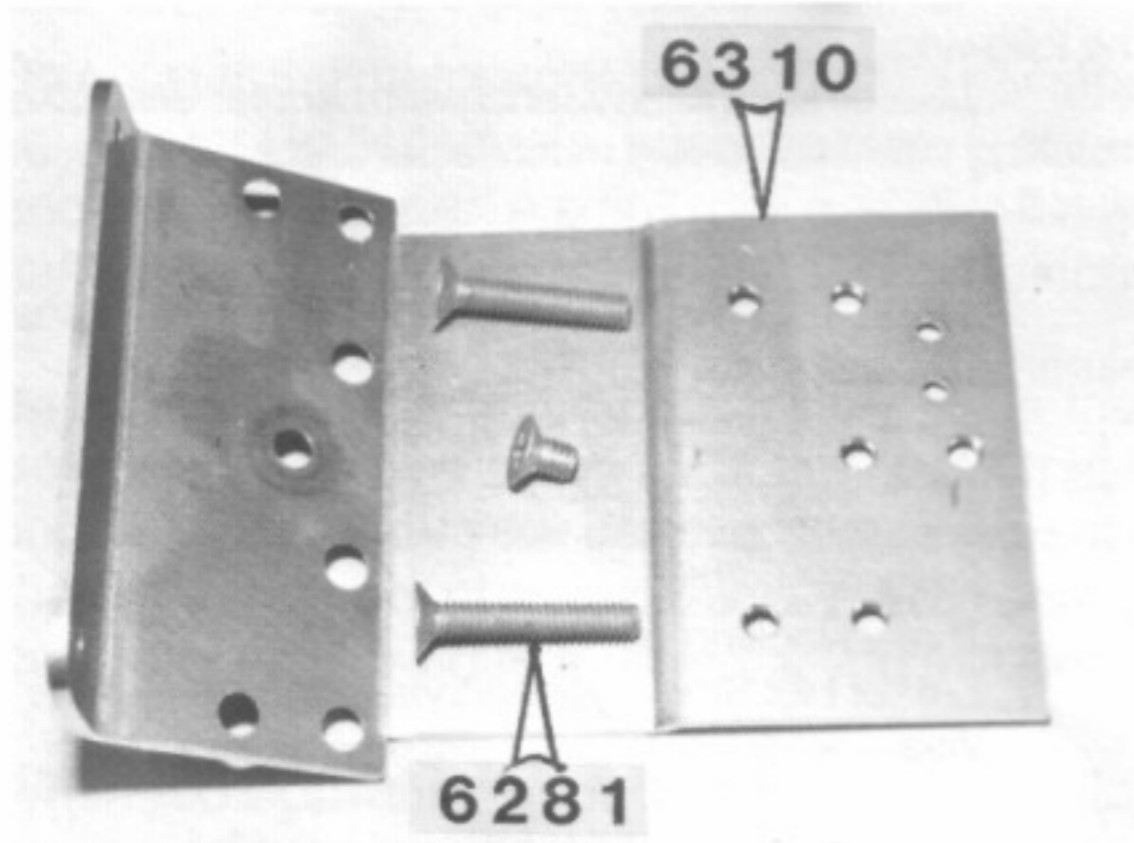

Fig. 1

Fig. 2 Take the gold aluminum chassis #6300 and install the nose piece as shown, with the #2 Phillips screwdriver. Note that all the chassis screws are aluminum and can be easily damaged by a worn screwdriver. Be sure yours is in good condition.

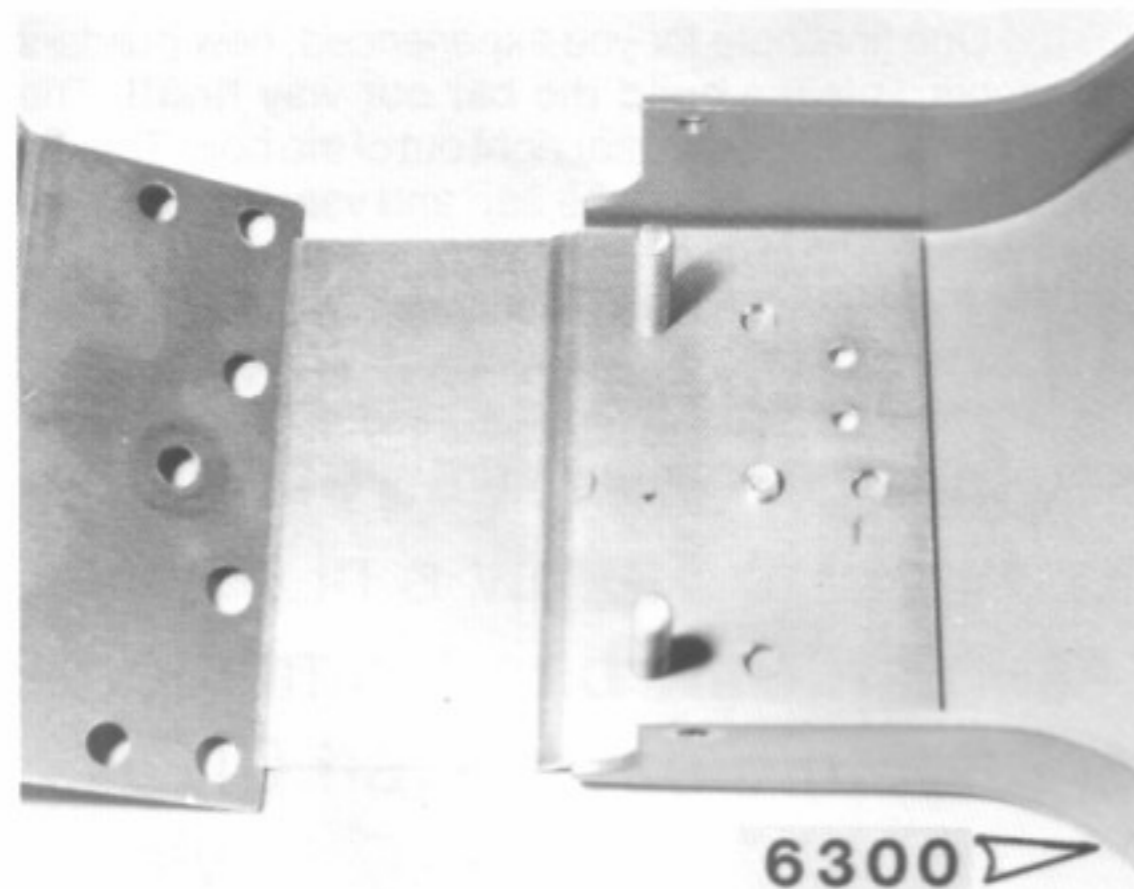

Fig. 2

Fig. 3 In bag #6-5, take one #6330 body mount, 2 washers and one short screw. (The long screw is used to extend the body mounts for other body styles.)

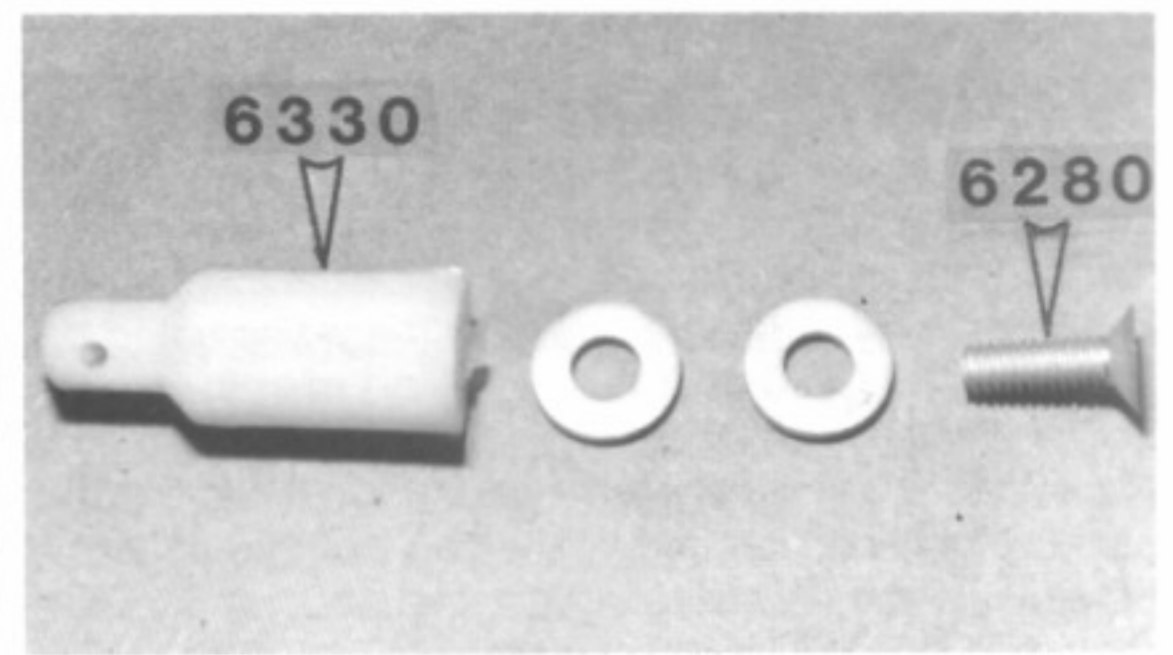

Fig. 3

Fig. 4 Install body mount as shown with body clip hole going left to right.

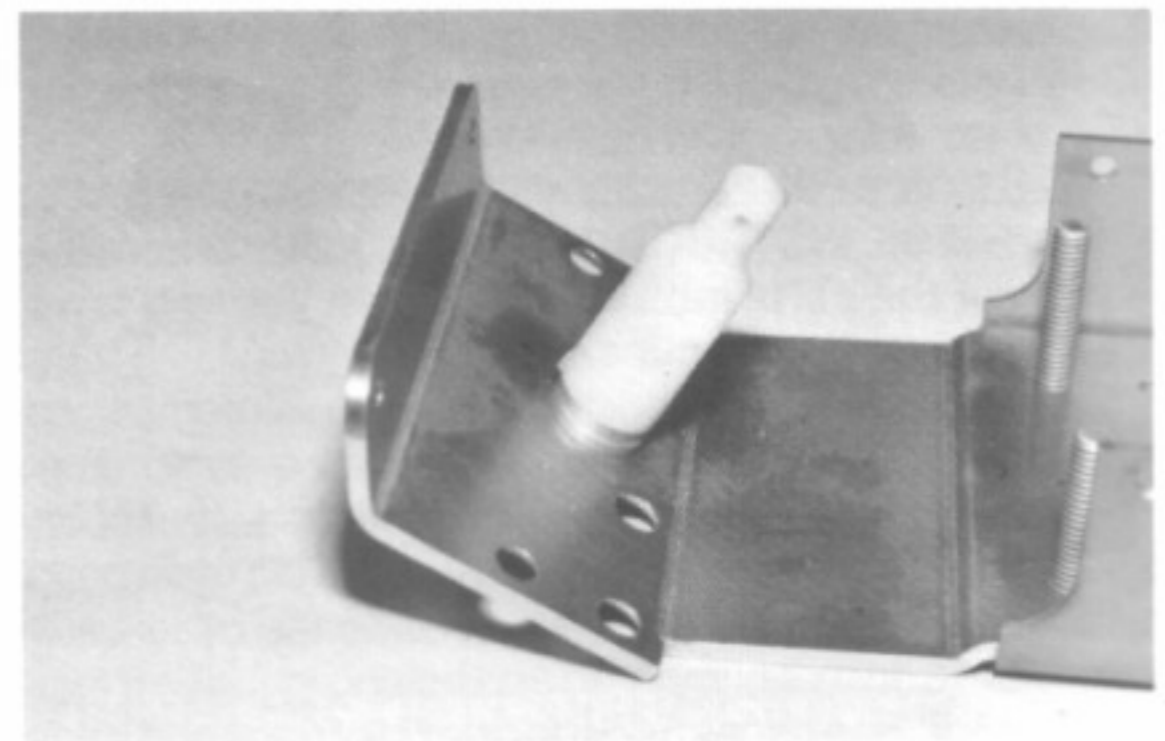

Fig. 4

□ **Fig. 5** In bag #6-1, take out the left hand front suspension mount #6207. This mount will have the letter L on the bottom. The left or right hand side of the car is determined by the driver as he sits in the car. His left hand will be the left side of the car and his right hand the right side.

NOTE: The left and right front suspension mounts are attached together by a thin "runner" that must be removed with scissors or a knife.

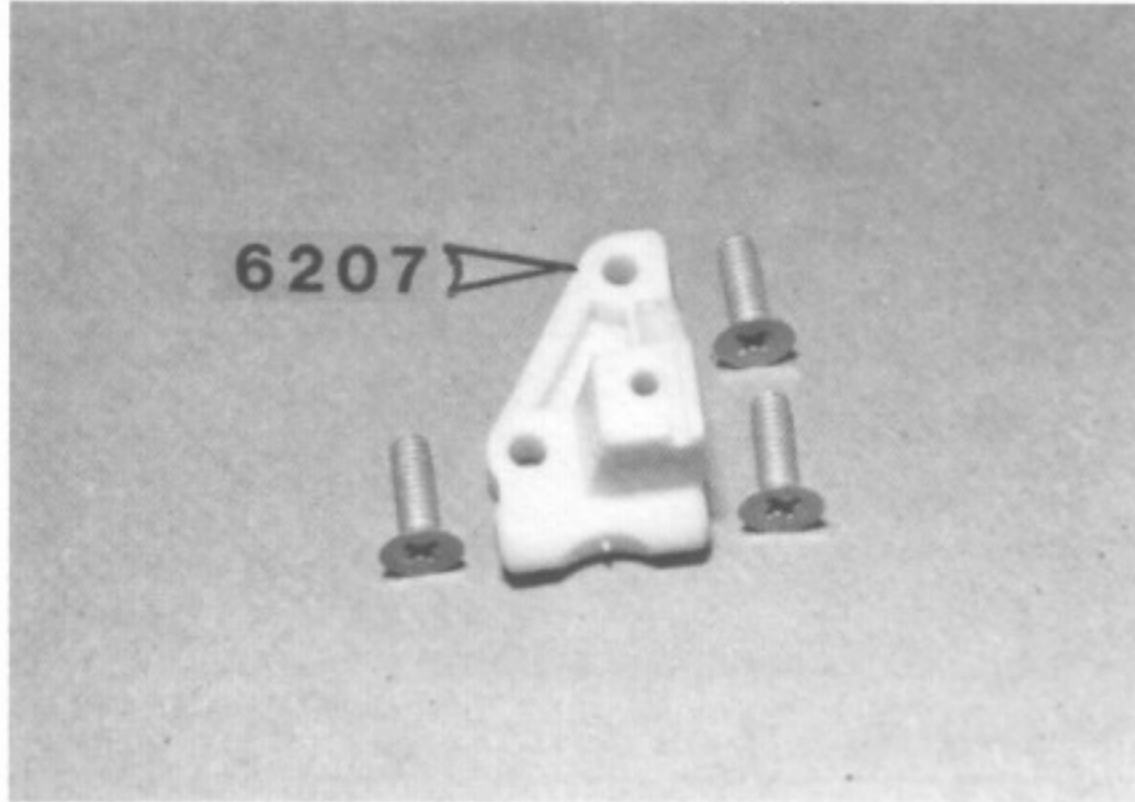

Fig. 5

□ **Fig. 6** Install the L.H. suspension mount, as shown, with the 3 Phillips screws. Now, install the right hand mount.

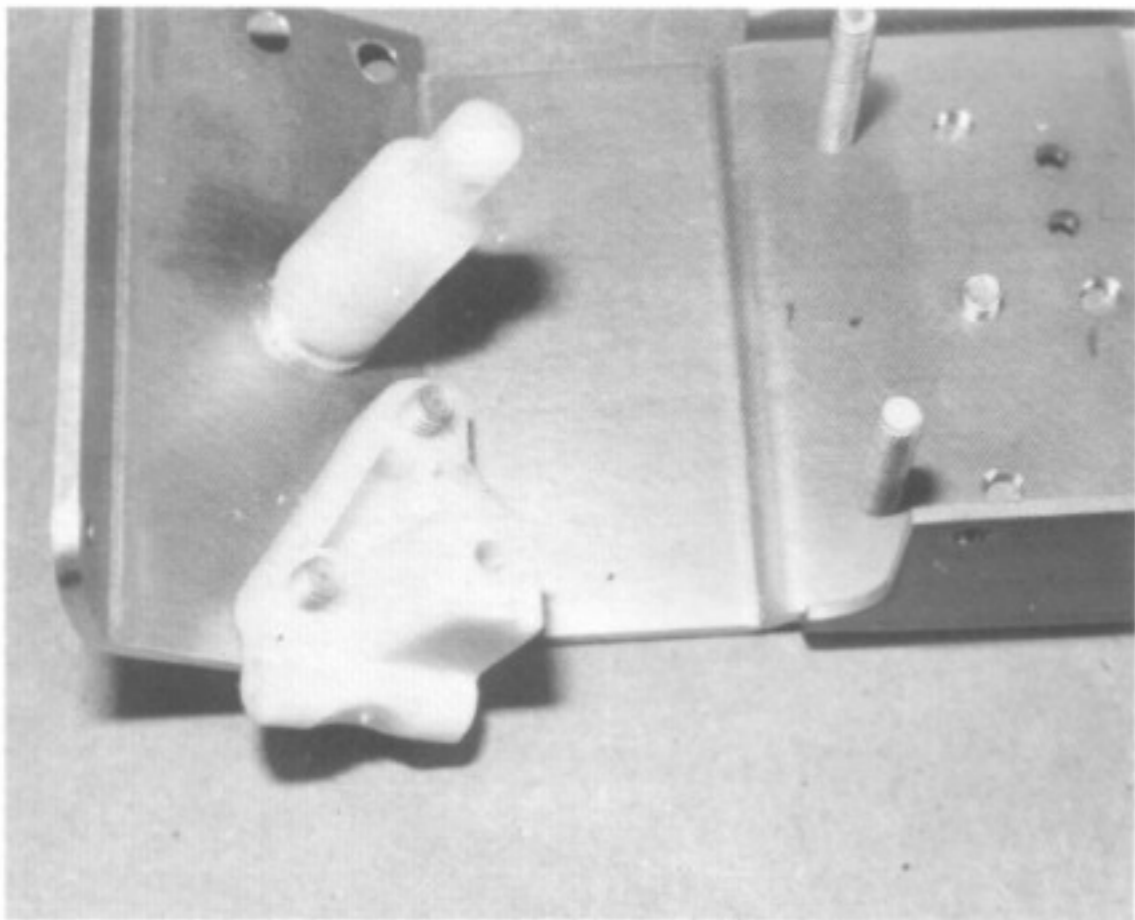

Fig. 6

□ **Fig. 7** In the same bag, take out the #6206 L.H. front A-arm, the #6226 inner pin and the package of "E" clips, as shown.

NOTE: The package of "E" clips is in the form of a "stack" or short roll with white paper glued around the outside (see Fig. 7a). There is a roll of "E" clips in three different bags. You will have more than enough to complete your car. Slip the pin into each end of the front A-arm #6206 to check the pin fit. The A-arm should be able to swing freely on the pin. Most racers keep a .126" and a .128" reamer in their toolbox to free up A-arms and to clean them after racing. We want the pin to fit tight in the mount #6207.

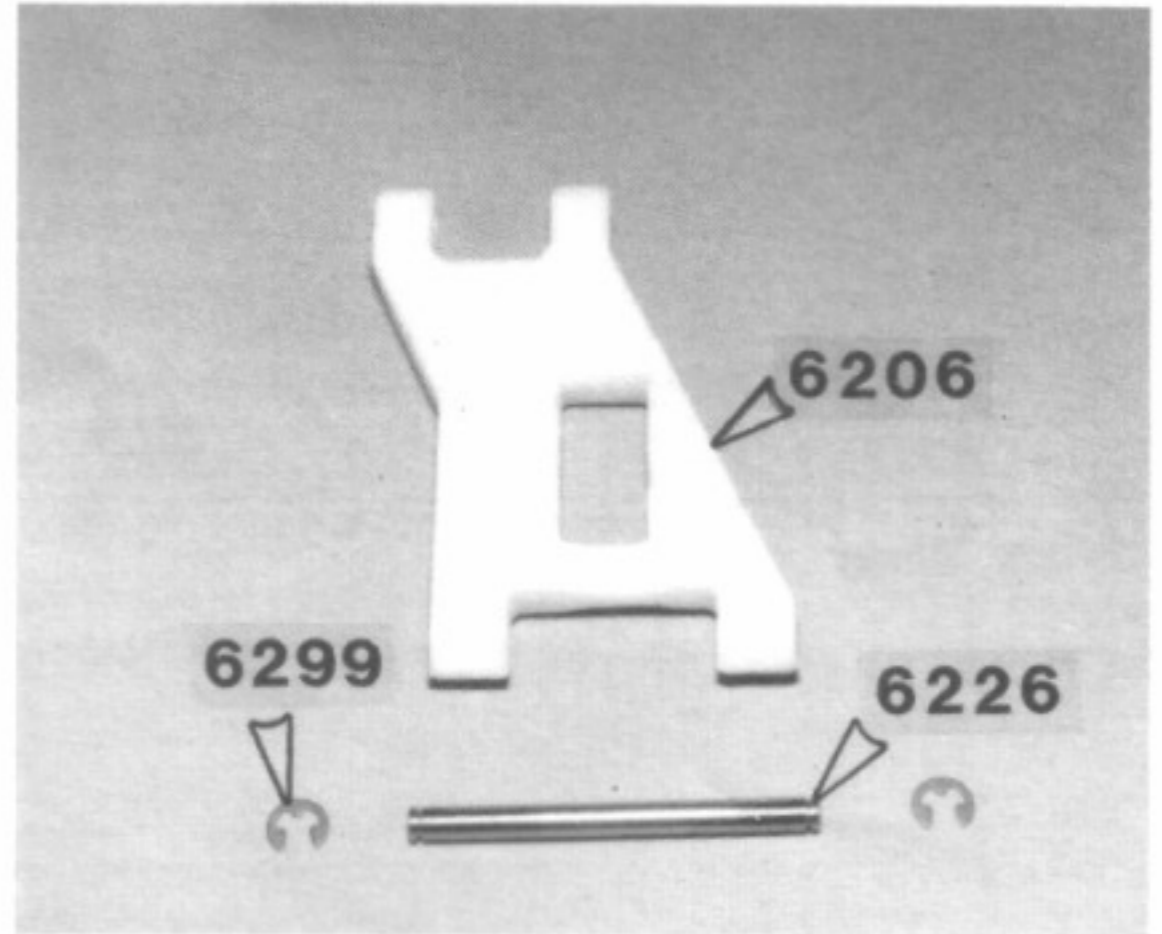

Fig. 7

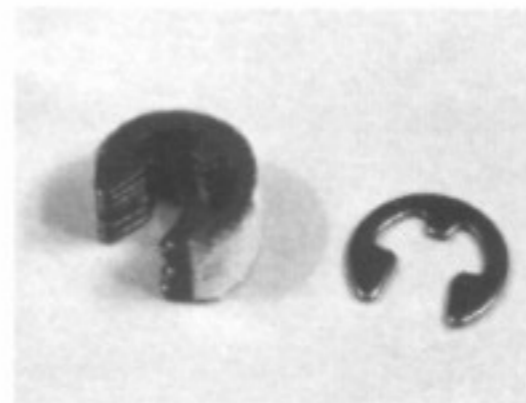

Fig. 7a

□ **Fig. 8** Line up the A-arm with the mount and push the pin through. Using a small screwdriver, install an "E" clip on each end of the pin. Now, install the R.H. side.

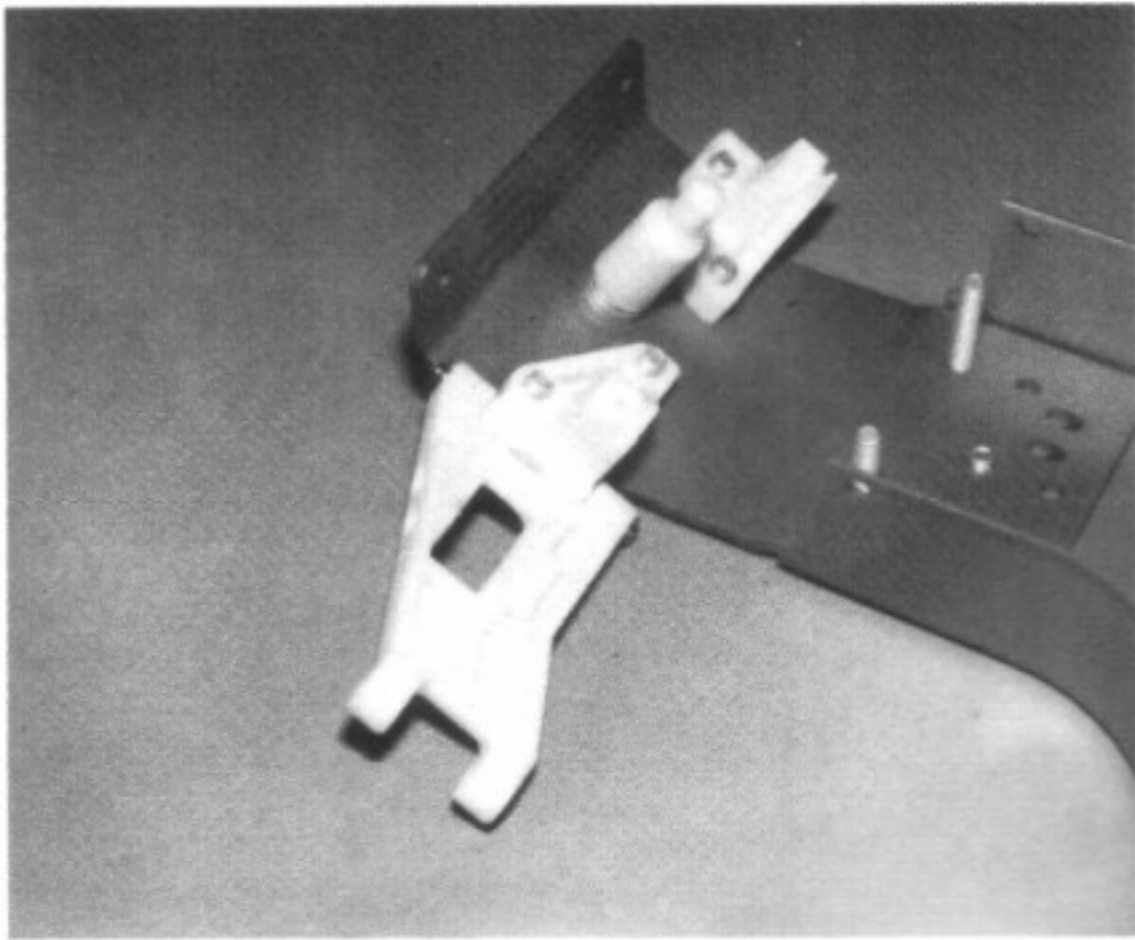

Fig. 8

□ **Fig. 10** Screw the short ball end #6270 into the #6217 steering block and secure it with the nut as shown. Assemble the right hand side, which will be inserted into the opposite side shown in Fig. 10.

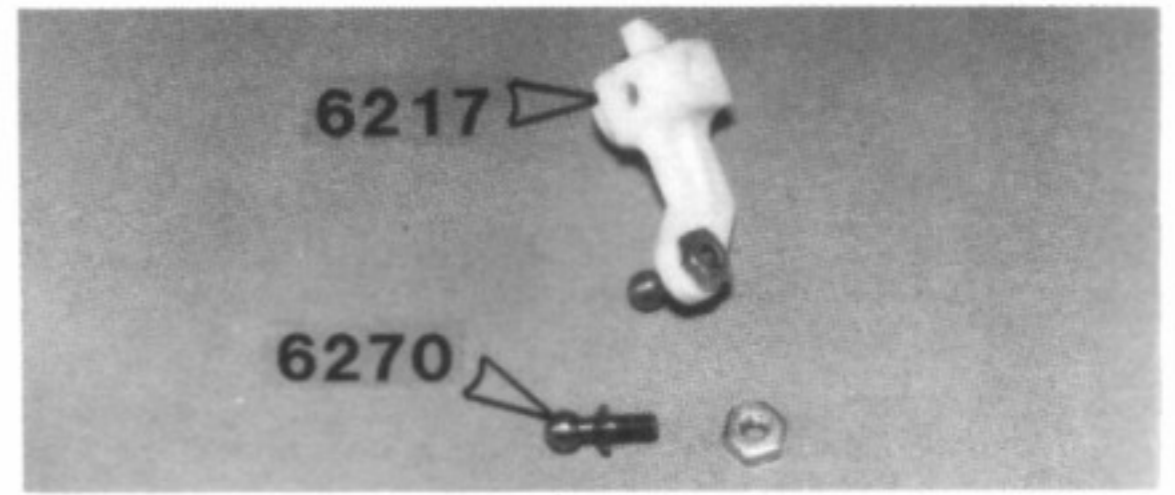

Fig. 10

□ **Fig. 9** From bag #6-14 screw the long ball end #6273 into the left hand front block carrier #6213 as shown, then screw on the locking nut. Assemble the right hand parts.

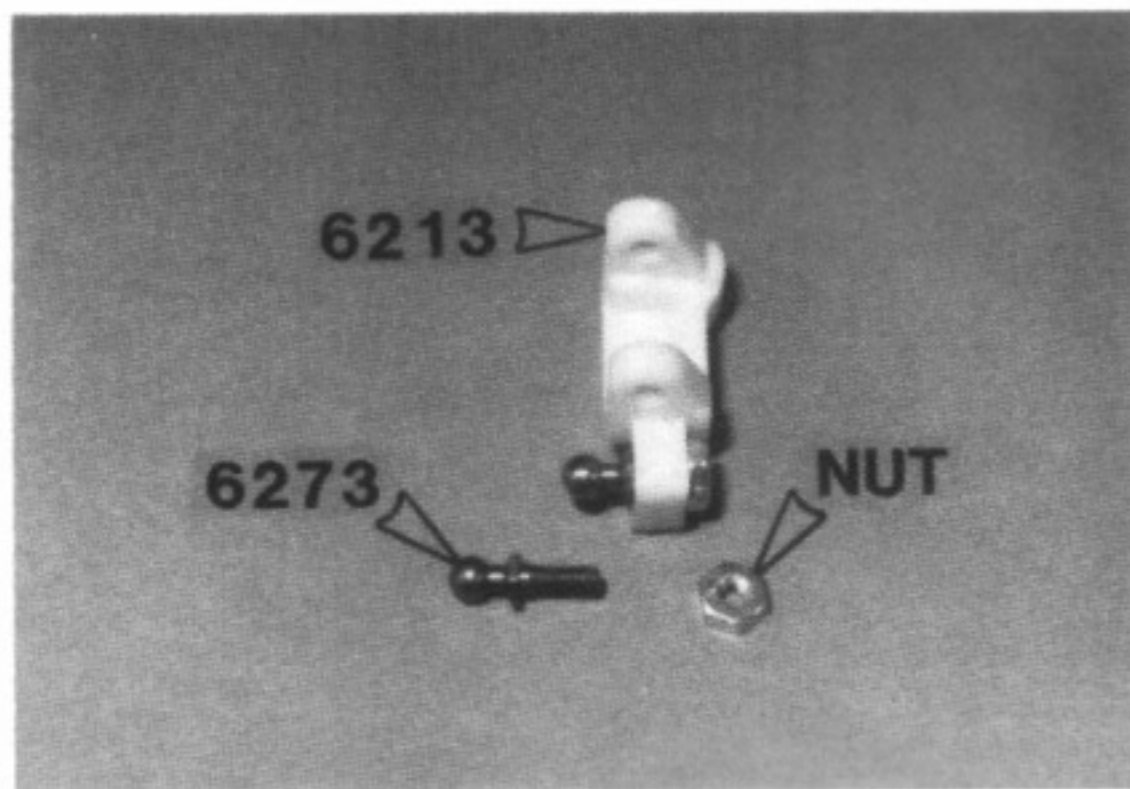

Fig. 9

□ **Fig. 11** Push the front axle #6218 into the steering block #6217 as shown so the hole in the axle lines up with the hole in the steering block. It may push together with your fingers. If not, LIGHTLY tap it into the hole. Assemble the right hand side in the same way.

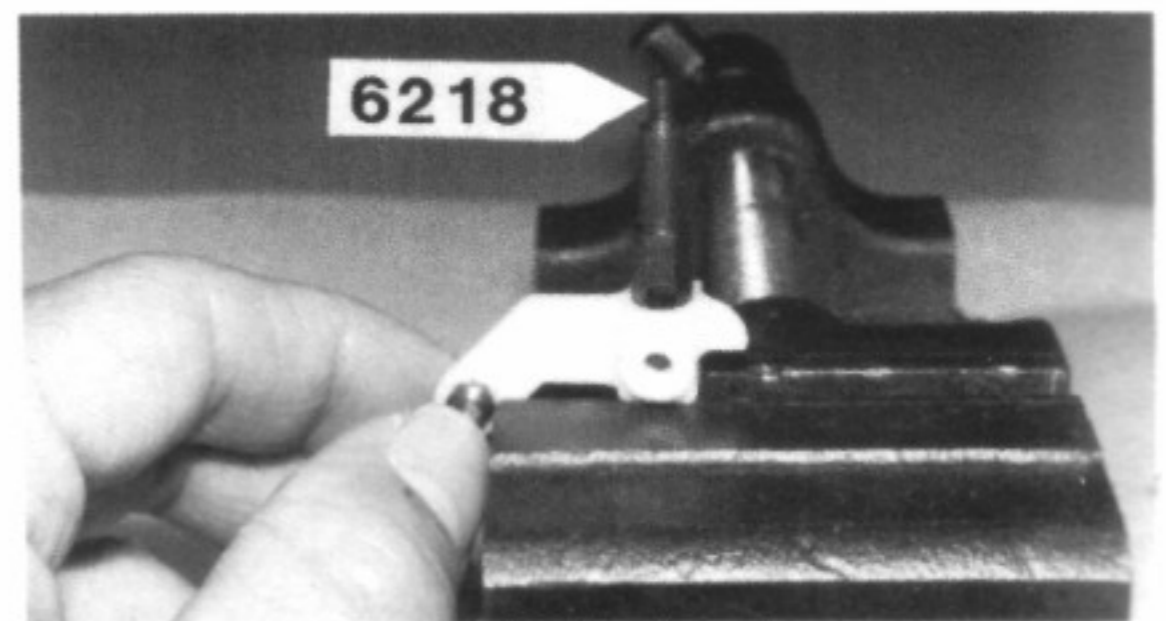

Fig. 11

□ **Fig. 11a** You'll notice that the hex part of the axle does not go all the way into the steering block. That's O.K. Just make sure the hole in the axle is lined up with the hole in the steering block.

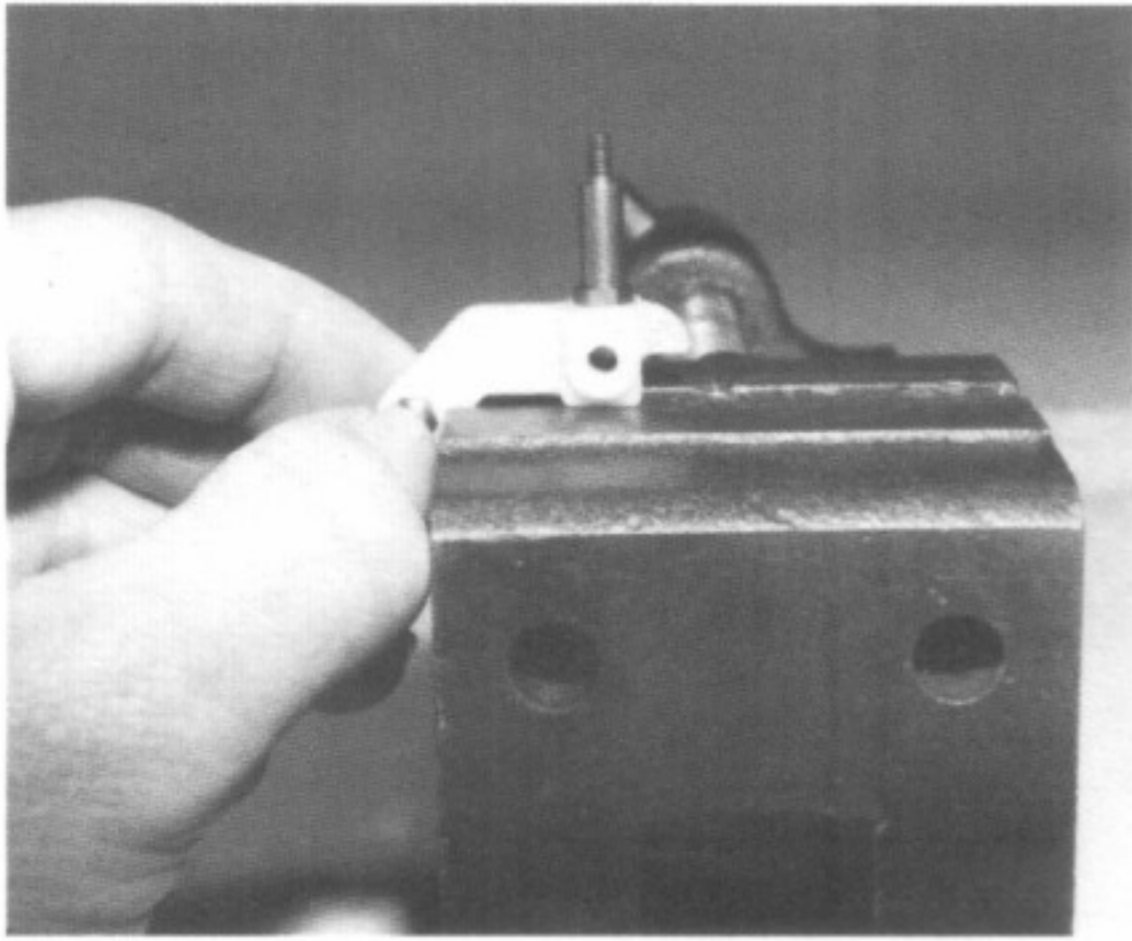

Fig. 11a

□ **Fig. 12 - 12a** Line up the steering block in the block carrier, as shown, and push the #6223 king pin through. Now, install "E" clips on the top and bottom ends of the pin. If you run out of "E" clips, there are extras in the shock bags. Install the R.H. steering block.

The pin will be loose in the block carrier but will be snug in the steering block, so you might have to lightly tap it in.

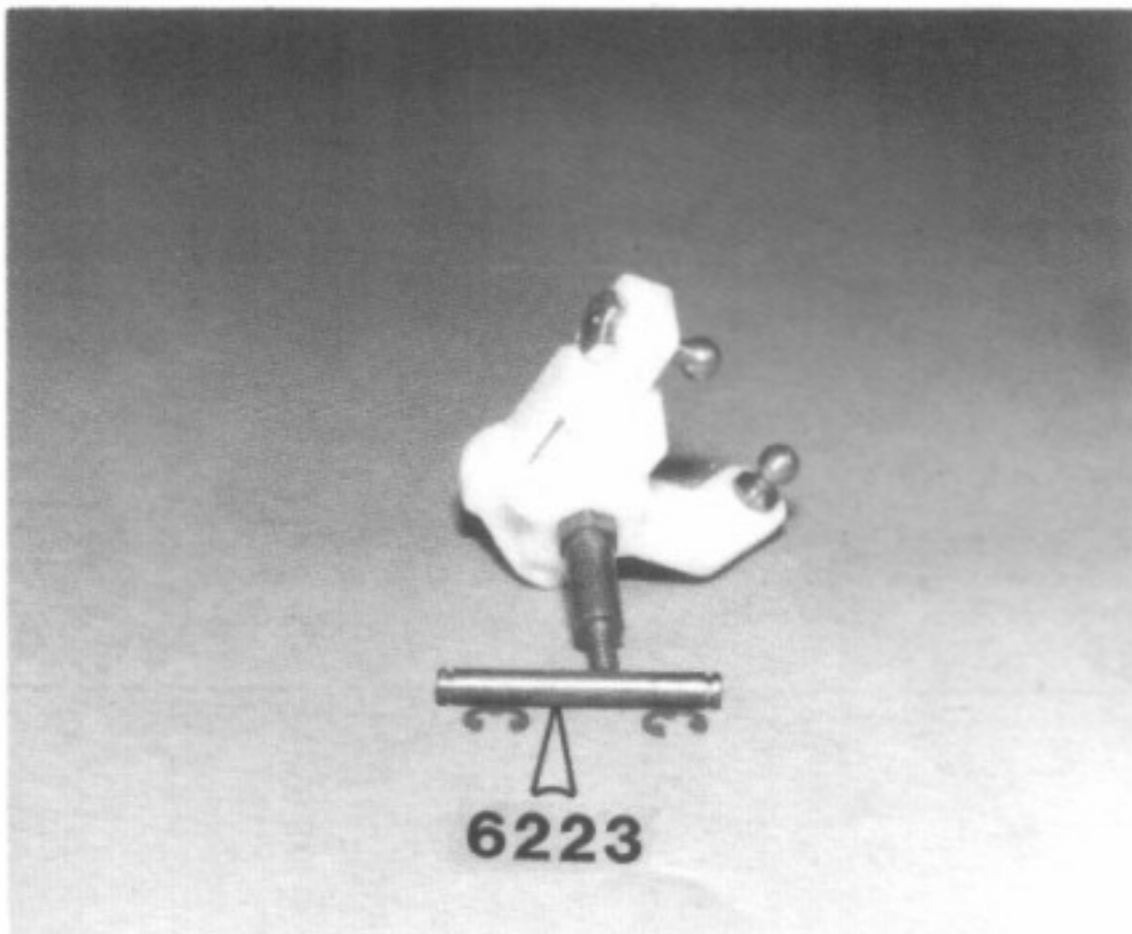

Fig. 12

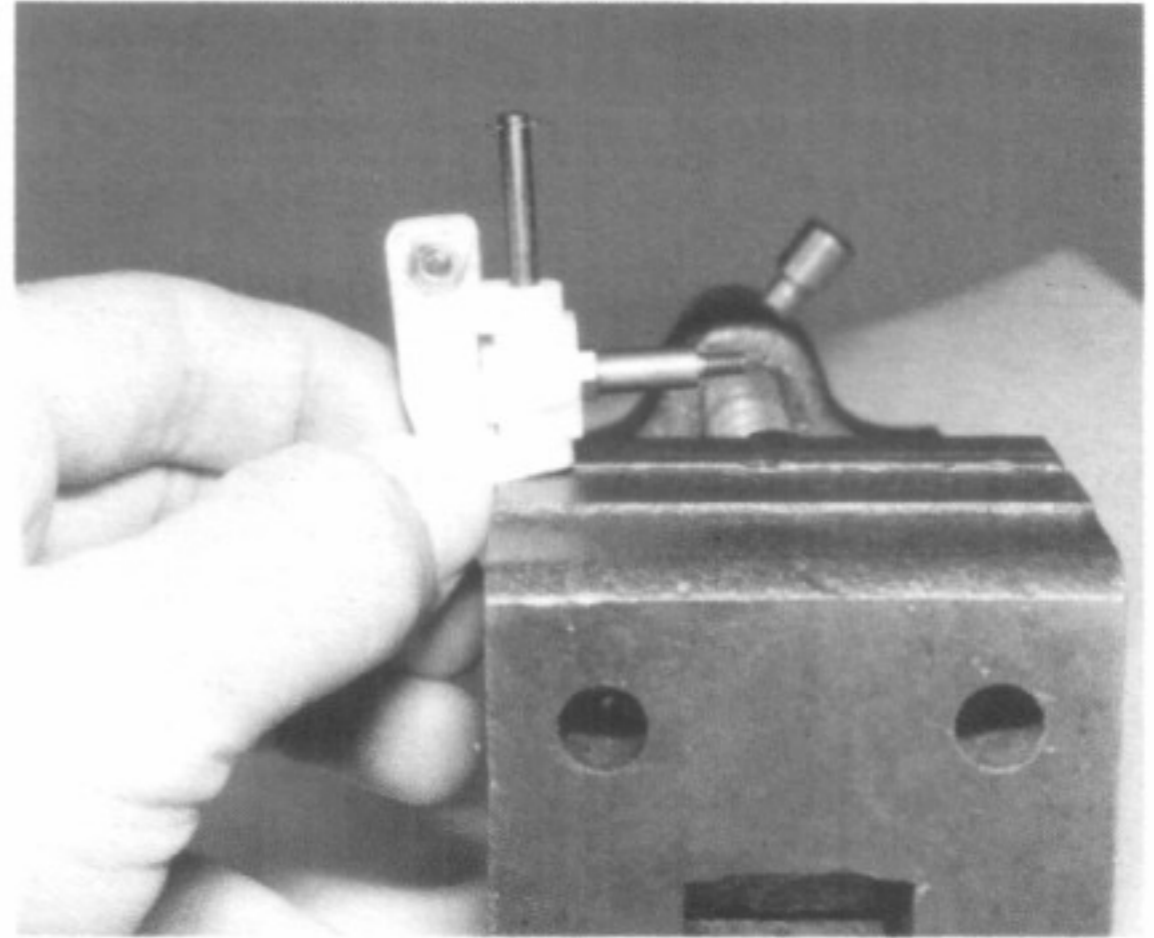

Fig. 12a

□ **Fig. 13 - 13a** Line up the holes in the block carrier with the holes in the A-arm and push the #6227 outer pin into the arm. Install the "E" clips. Do the R.H. side.

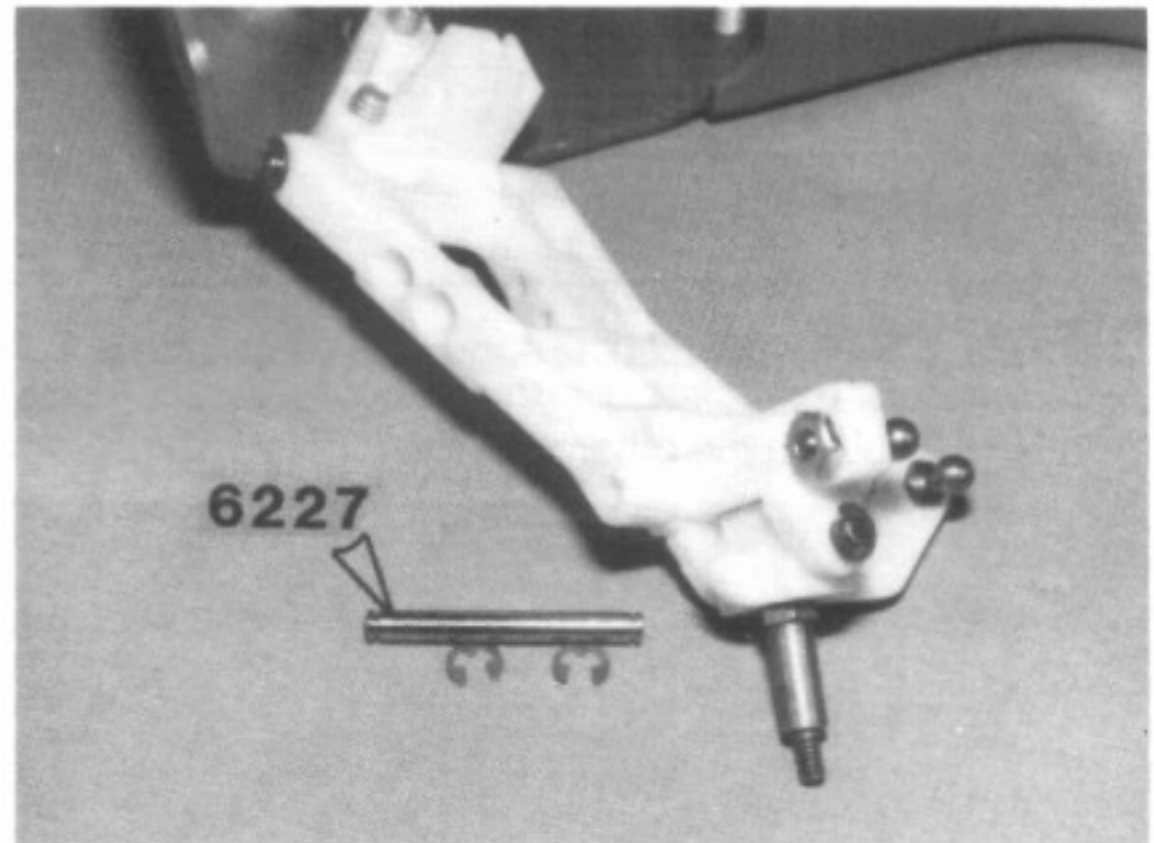

Fig. 13

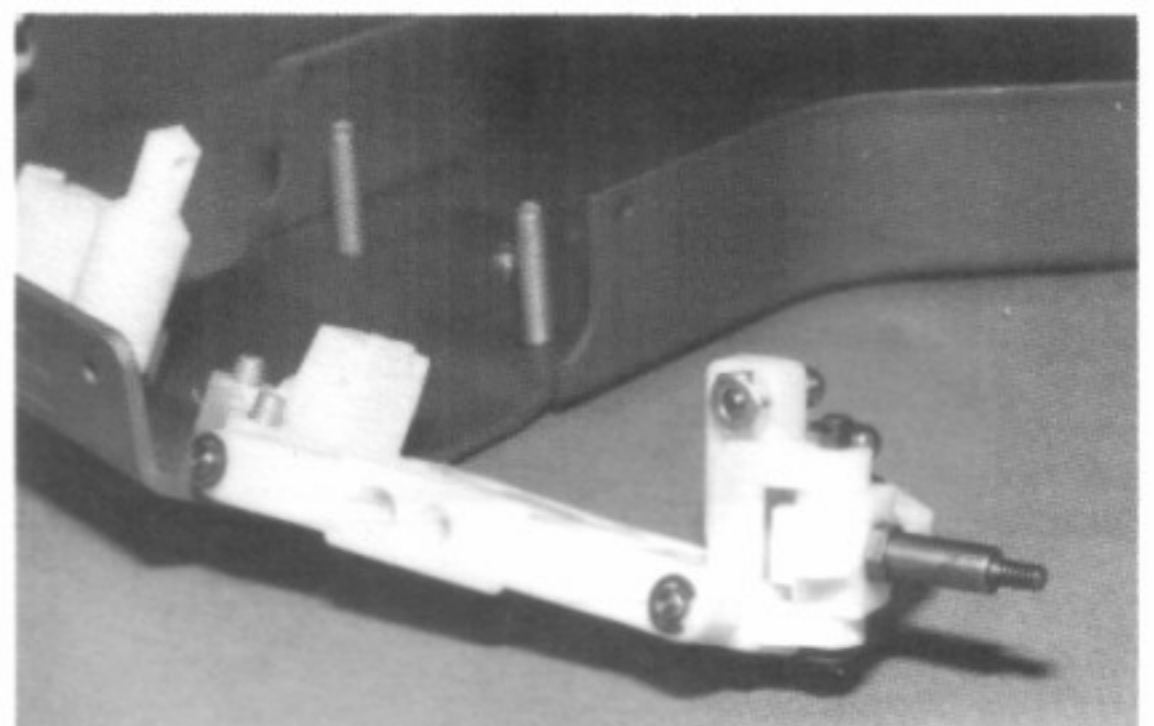

Fig. 13a

Fig. 14 Take the #6231 front shock strut out of the same bag. In bag #6-10 take out 2 of the 4/40 screws and install them in the shock strut in the locations shown.

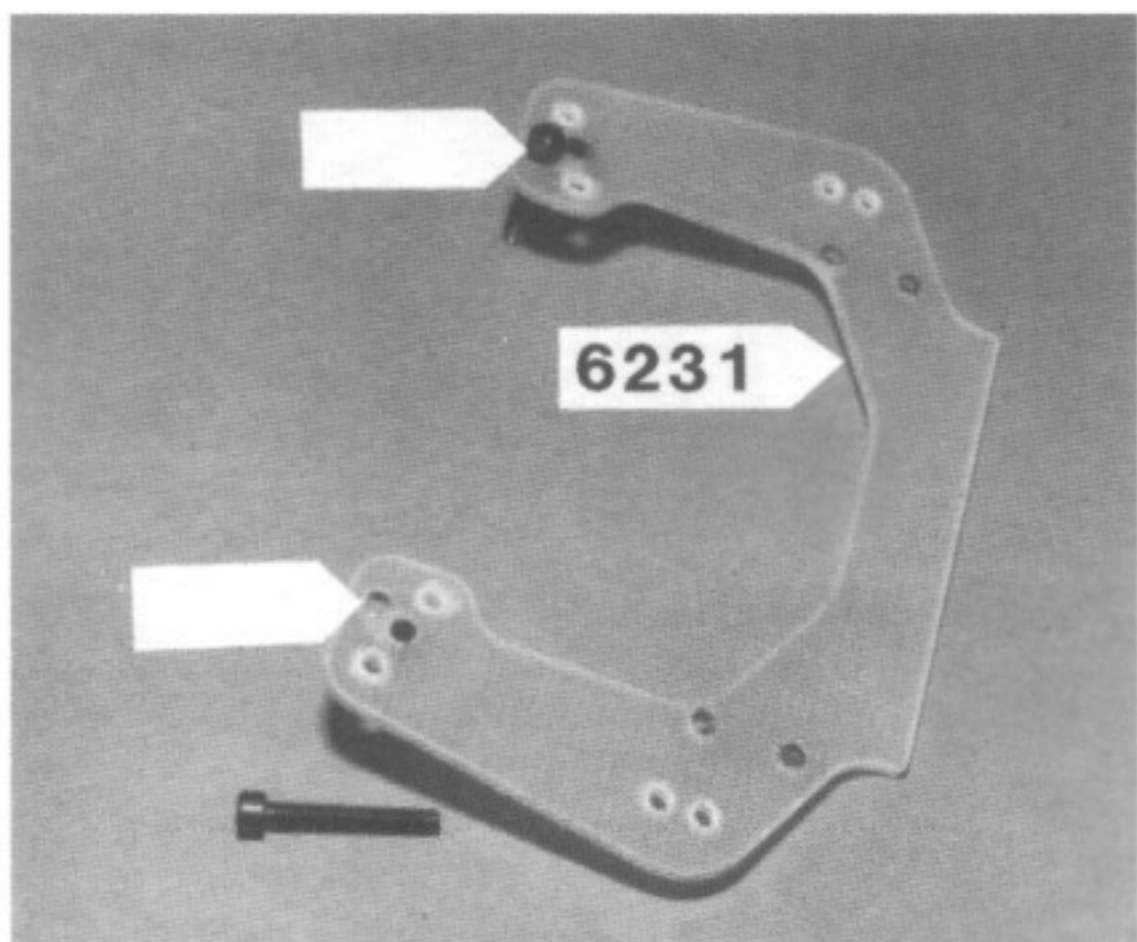

Fig. 14

Fig. 15 From bag 6-1 take the 2 short 4/40 screws and install the shock strut onto the 2 front suspension mounts. If the holes don't line up, loosen the aluminum screws in the chassis, align the parts and tighten all the screws.

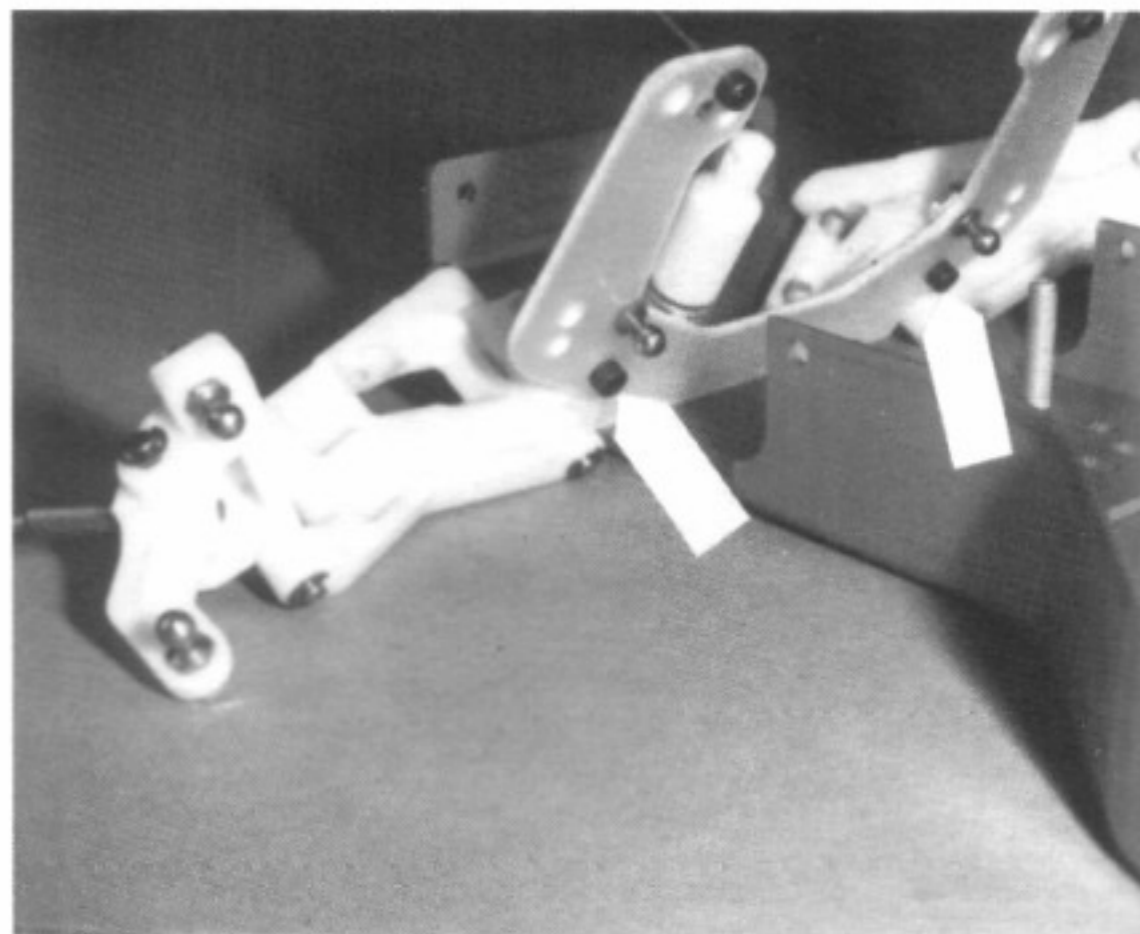

Fig. 15

Fig. 14a Take 2 of the short #6270 ball ends and install them in the shock strut in the locations shown. Then install the 2 nuts on the other side.

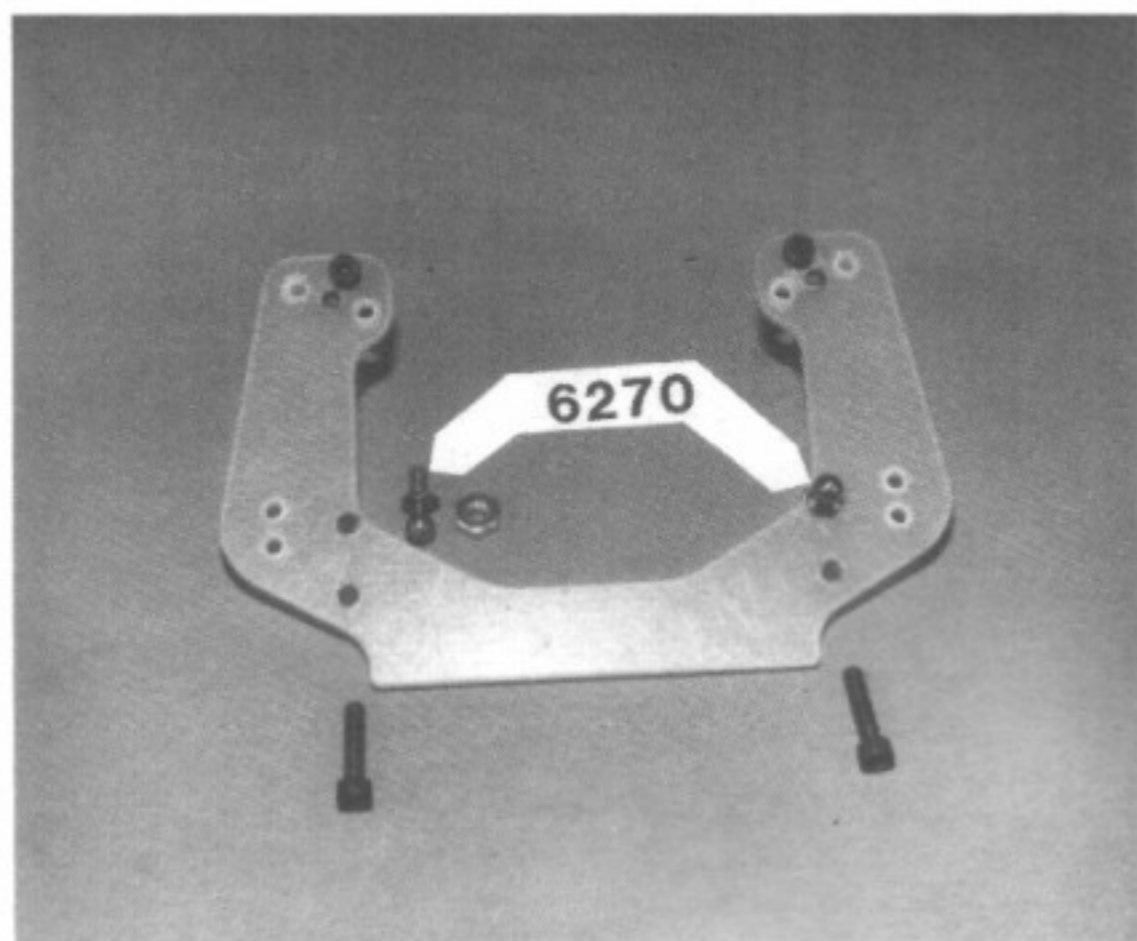

Fig. 14a

Fig. 16 In bag #6-1 take out the 2 #6259 threaded turnbuckles, and from bag #6-14 take out the #6274 plastic ball rod ends, as shown. Twist the rod ends and take 4 of them off.

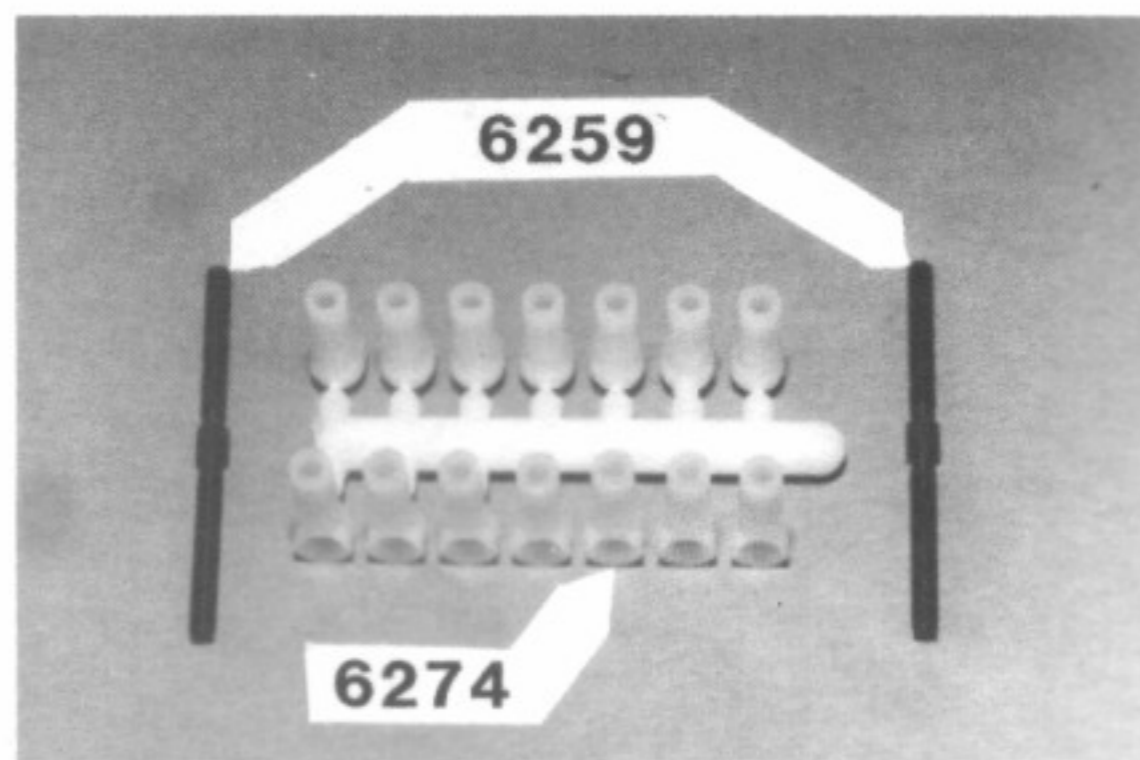

Fig. 16

Fig. 17 Screw the plastic ball rod ends onto the rods, as shown. The rods have a LH thread on one end and a RH thread on the other end, so they will screw on in different directions. Screw them on evenly to the dimension shown, which is measured from the center of the ball cup.

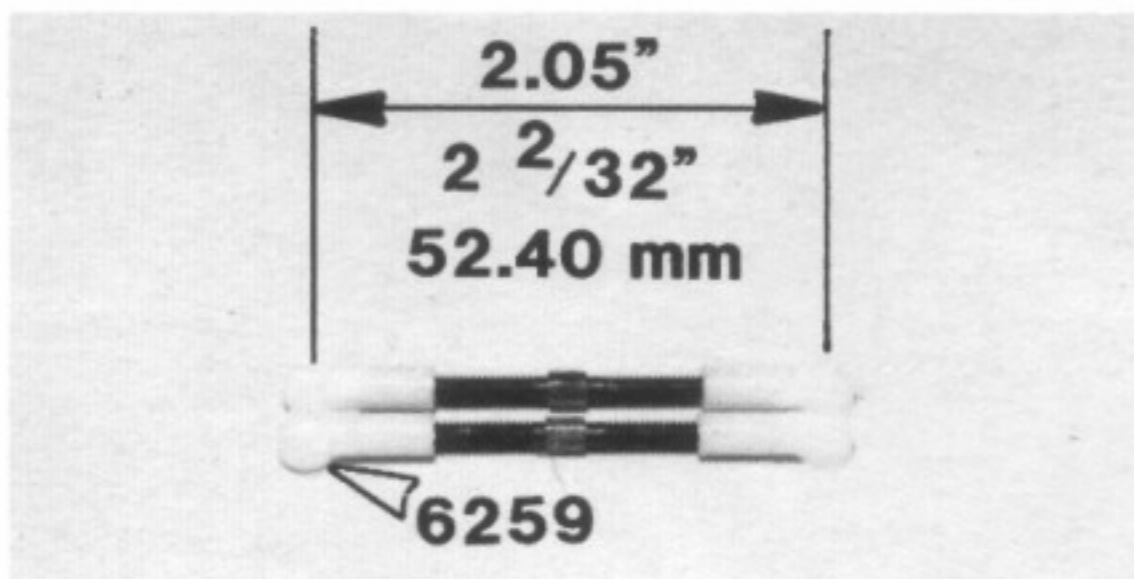

Fig. 17

Fig. 18a The rod ends can be removed quite easily from the balls by holding the rod end with a pliers, as shown, and twisting the rod end off the ball, as shown.

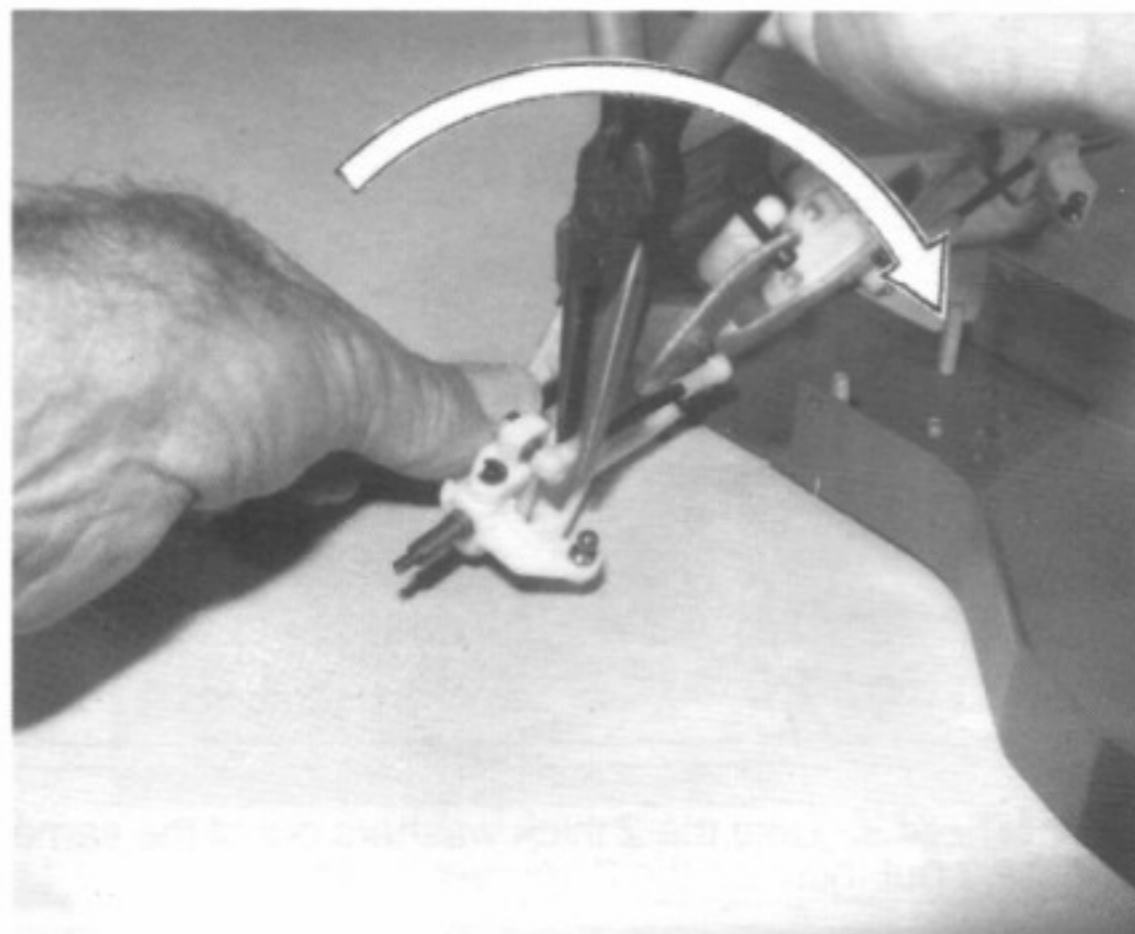

Fig. 18a

Fig. 18 Snap the rods on the metal balls, as shown. You'll probably have to use pliers. Do the R.H. side.

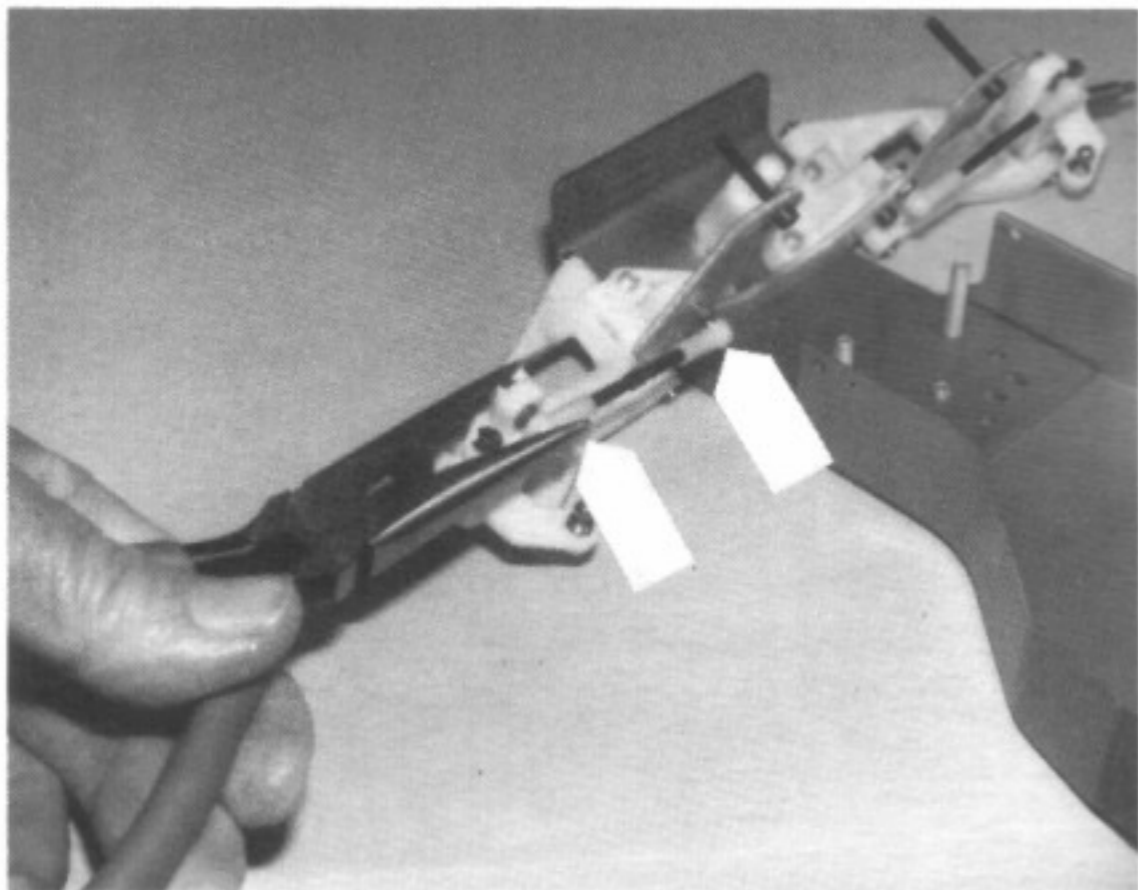

Fig. 18

Fig. 19 In bag #6-2, take the #6255 servo saver parts out, and install the 4 short ball ends, as shown.

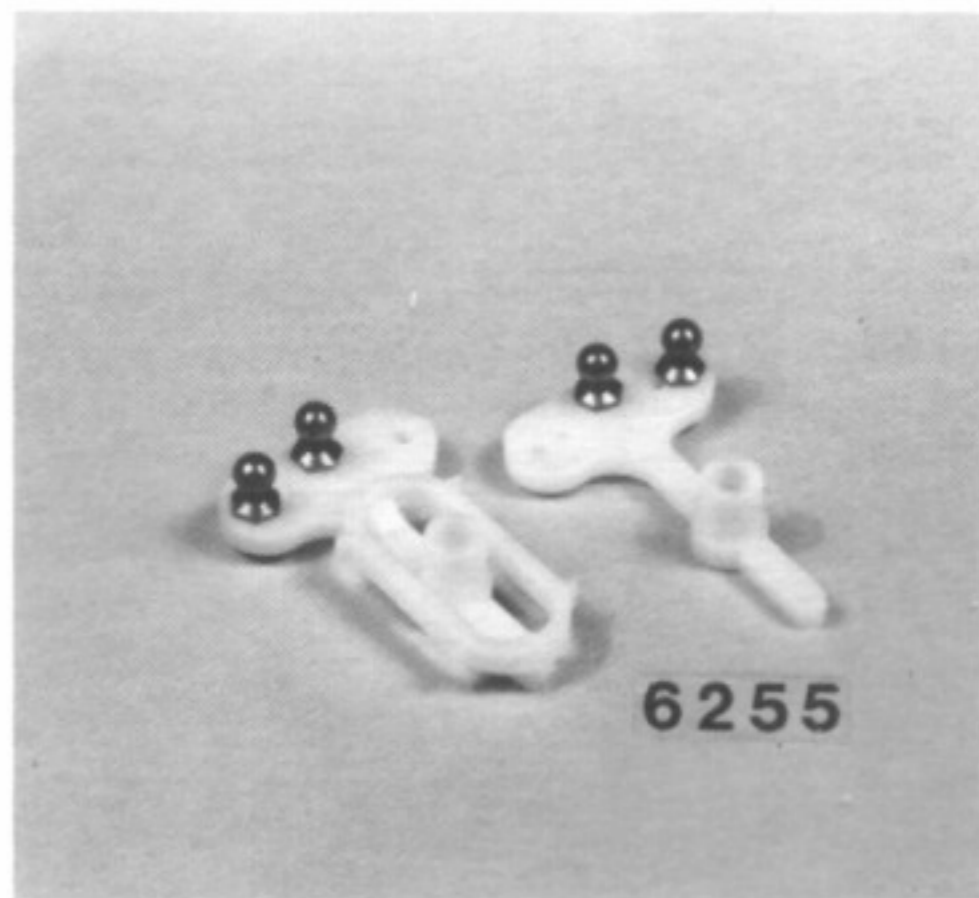

Fig. 19

- Fig. 20** Locate the servo saver arm...
- Fig. 21** And install it to the servo saver, as shown.

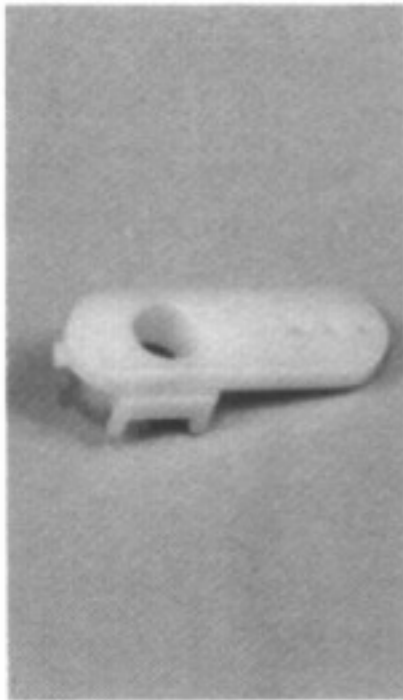

Fig. 20

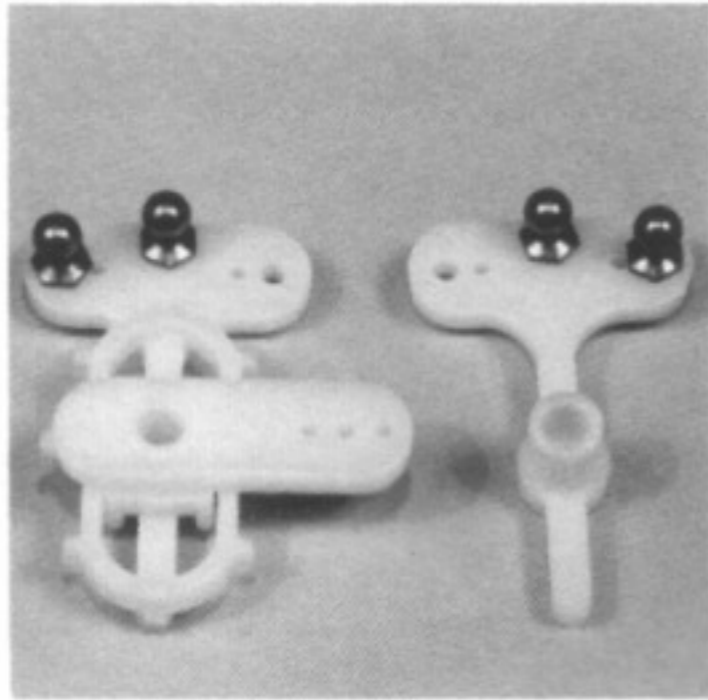

Fig. 21

- Fig. 22** Take the 2 thick washers out of the same bag, and put them on the 2 screws, as shown.

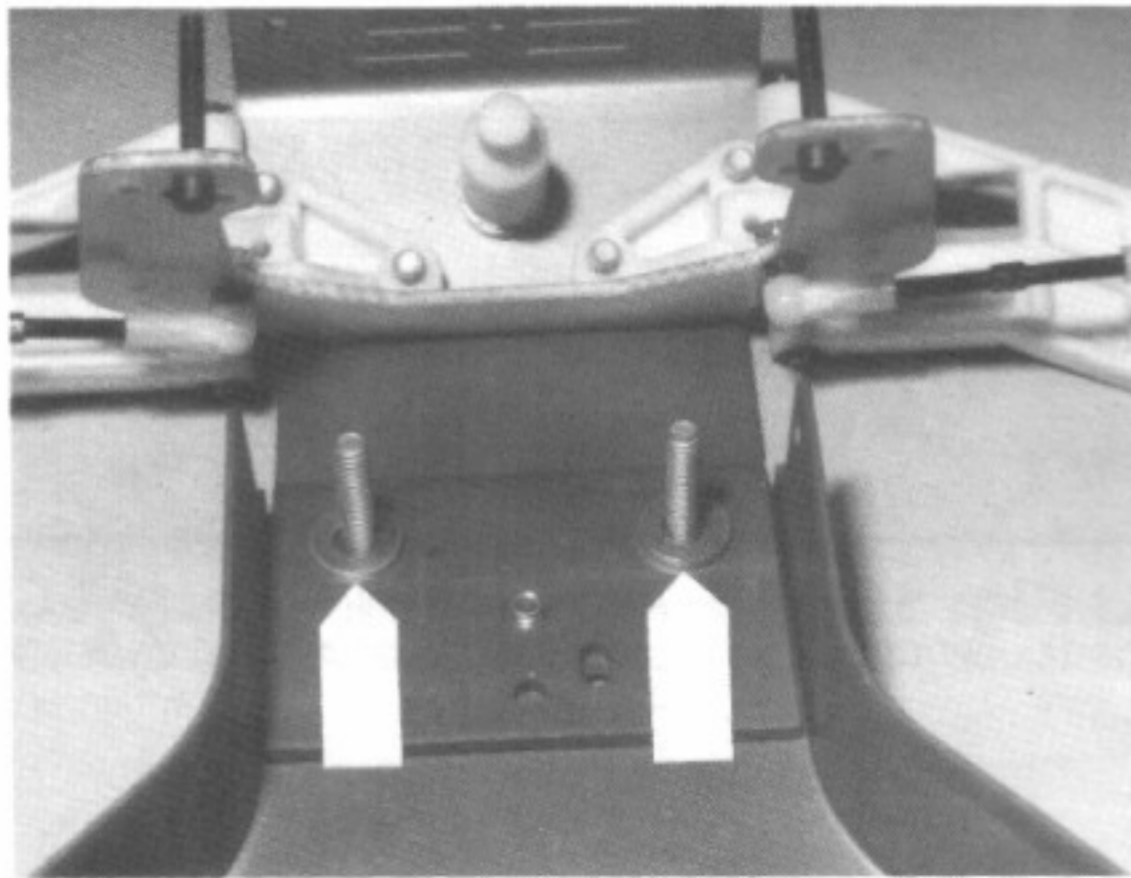

Fig. 22

- Fig. 23** Take the two long and one short turnbuckles and screw on the six plastic ball cups to the lengths shown.

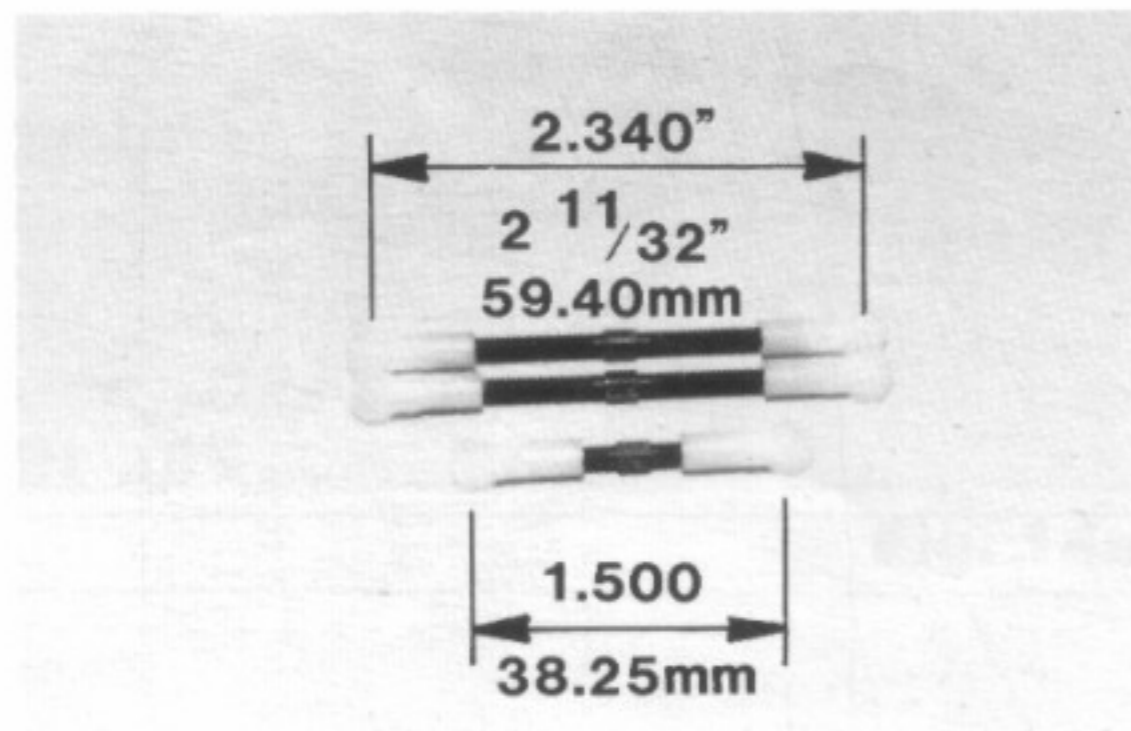

Fig. 23

- Fig. 24** Take the short rod and pop it on the servo saver with a pliers, as shown.

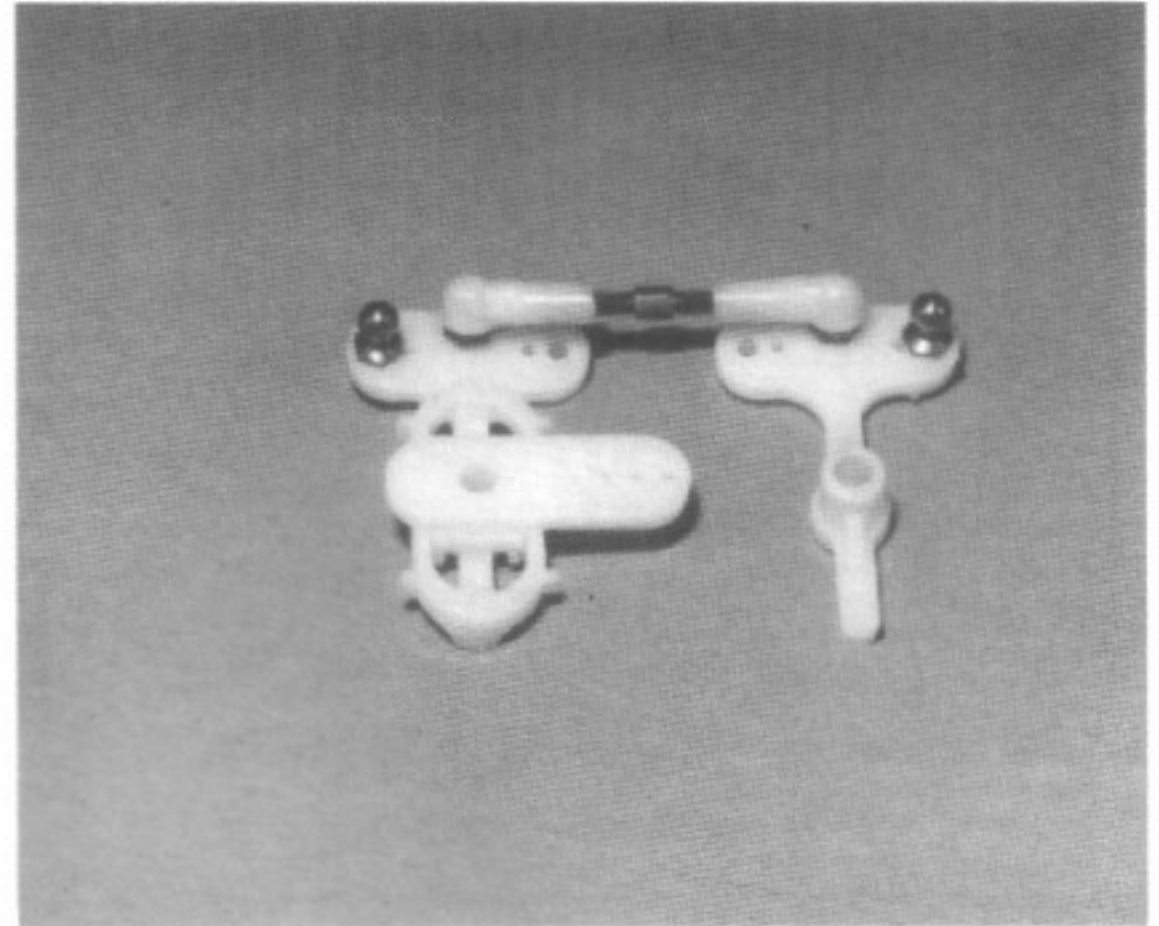

Fig. 24

- Fig. 25** Place the servo saver onto the 2 screws, as shown. Take the 2 nylon nuts and screw them down until the servo saver starts to tighten, then back the nuts off about 1/2 turn until the servo saver arms pivot freely. (Ignore the tube struts shown in photo. They will be installed later.)

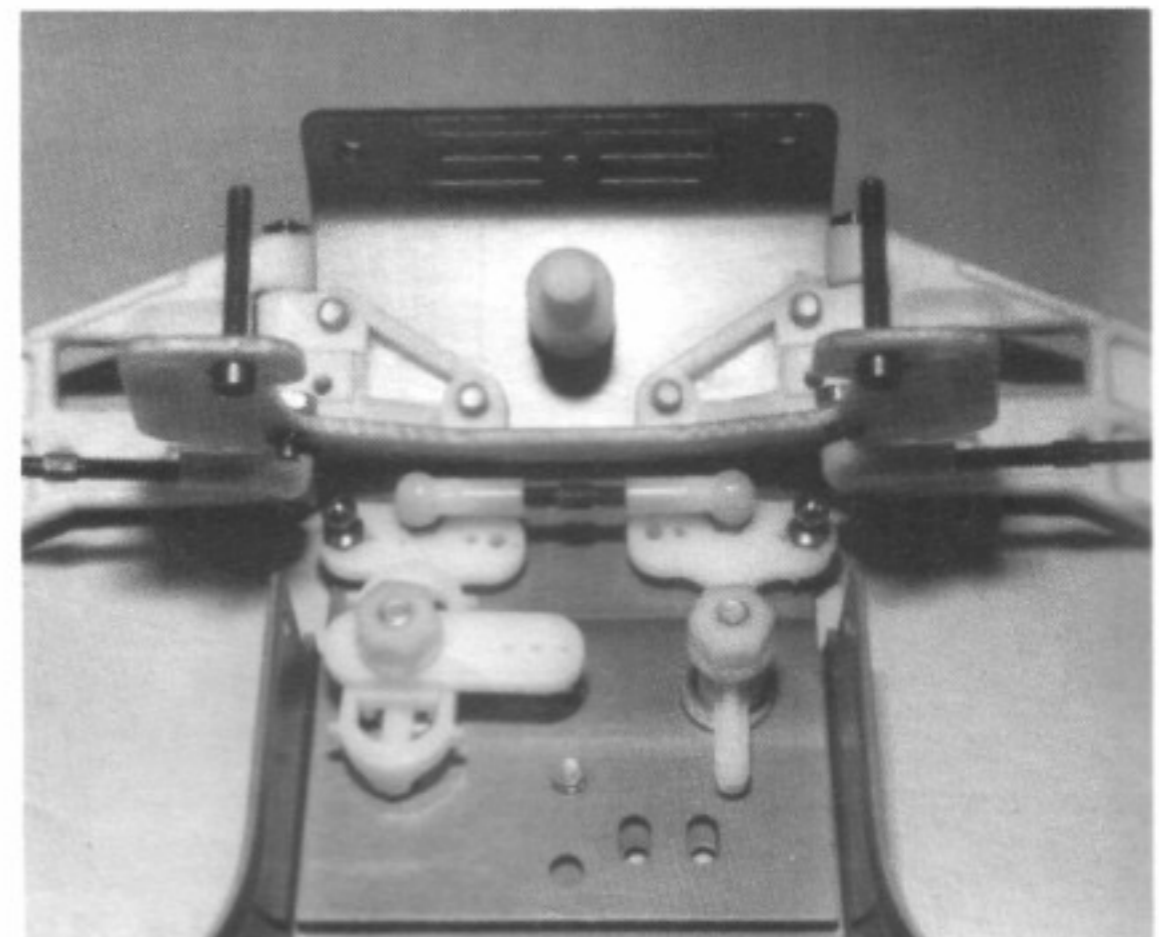

Fig. 25

Fig. 26 Snap the L.H. and R.H. tie rods on, as shown.

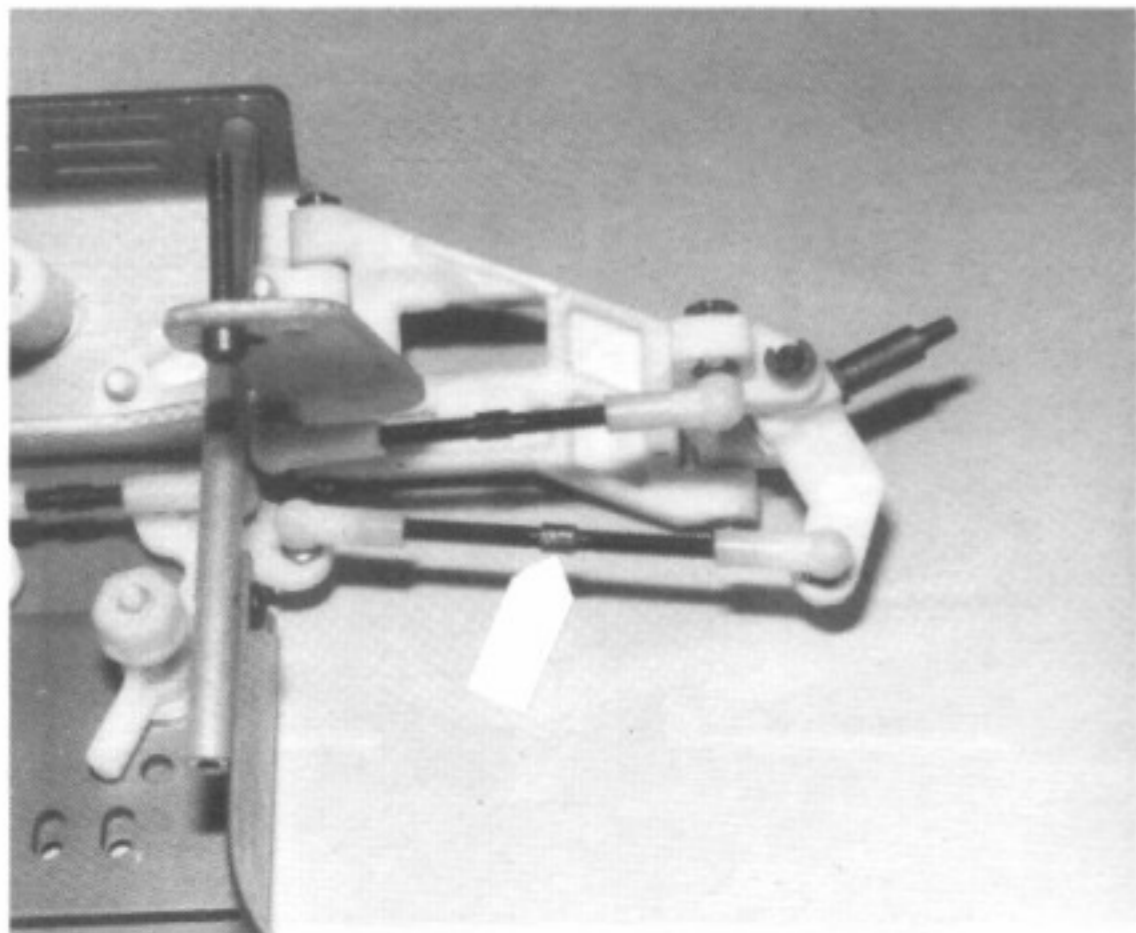

Fig. 26

Fig. 27 In the #6-12 bag, take out the #6609 drive gear pivot. Also in the #6-12 bag is a small bag with screws. In this bag is a small split roll pin. This pin goes into the hole in the pivot as shown. Use a needle nose pliers to hold the pin and lightly tap it into the hole.

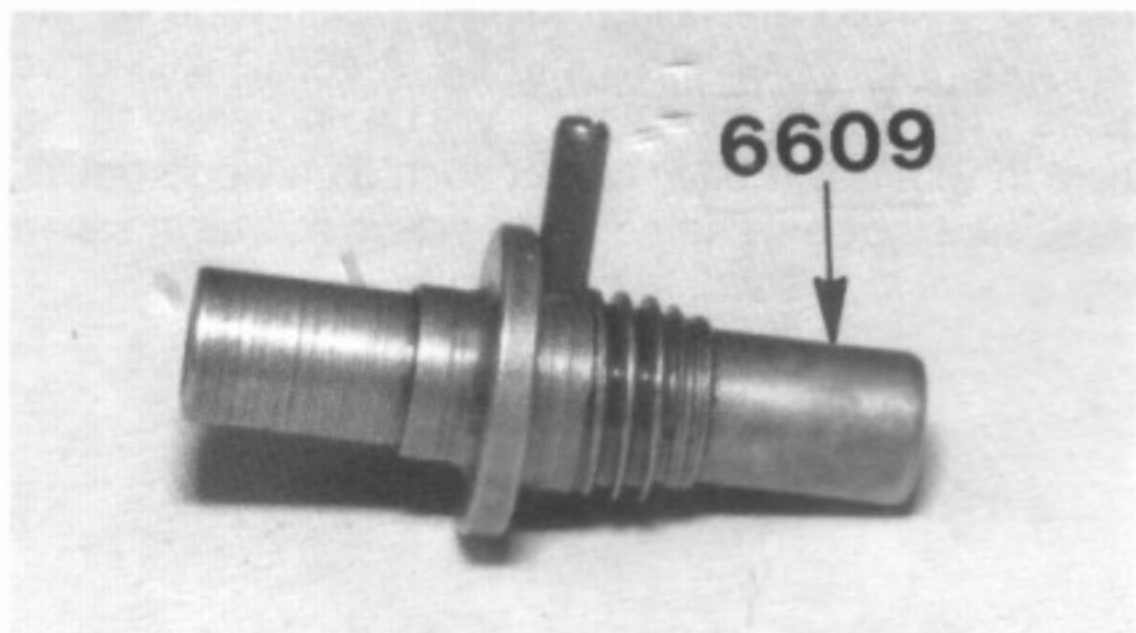

Fig. 27

Fig. 28 Tap the pin into the hole until it's evenly centered on both sides.



Fig. 28

Fig. 29 Take the #6611 aluminum spine plate out of the bag. Using a vise, or a piece of wood with a 1/4" hole in it, carefully tap the pivot into the plate. Make sure the pin is centered with the slots in the plate, and that the flange of pivot is flush against the surface of the plate.

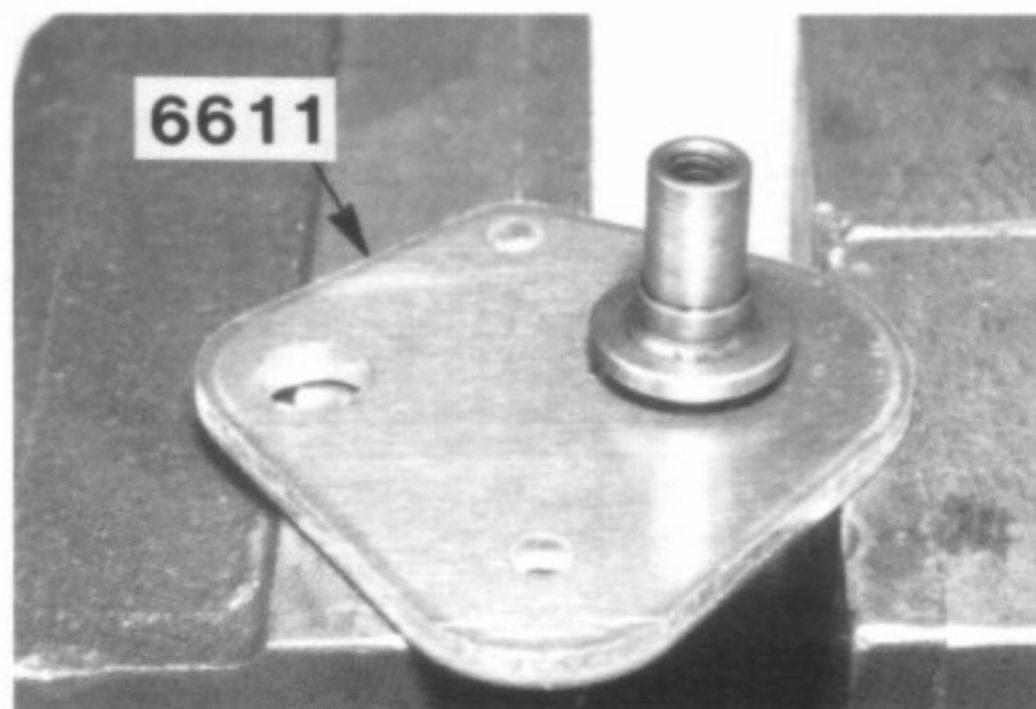

Fig. 29

Fig. 30 Take the large thin 1/4-28 hex nut out of the bag. Turn the plate over and install the nut. Tighten the nut with a socket or open-end wrench while holding the spine plate. You may want to put a drop of thread-locking compound on the threads to make sure the nut doesn't come loose.

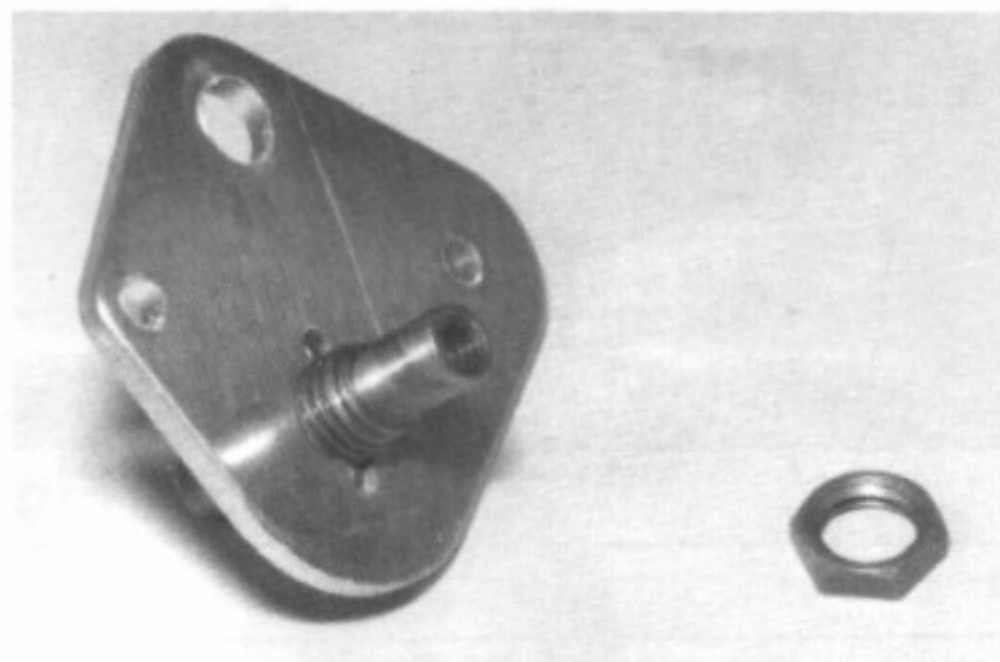

Fig. 30

Fig. 31 The pivot should look like this installed.



Fig. 31

□ **Fig. 32** Take the #6610 idle gear pivot and gently tap it all the way into the aluminum plate, again making sure that the flange touches all the way around.

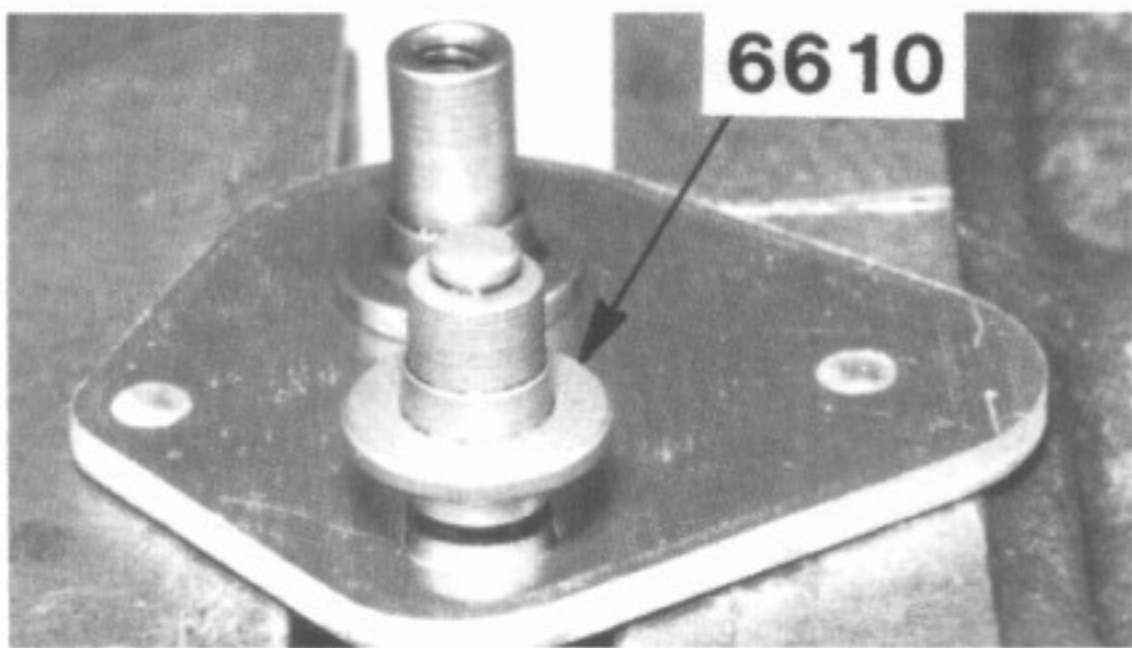

Fig. 32

□ **Fig. 33** Turn the plate over and take the flat steel washer and slip it over the pivot as shown by the arrow.

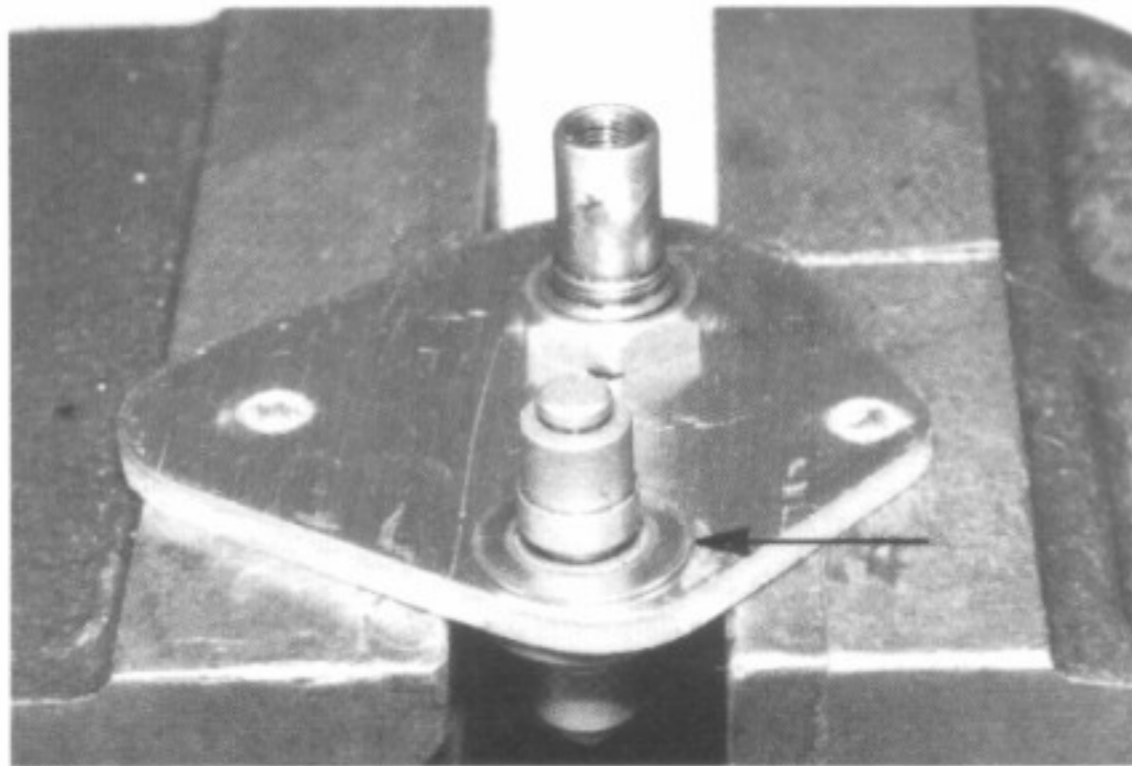

Fig. 33

□ **Fig. 34** Install the large curved "E" clip, as shown, with the center up, and the ends down.

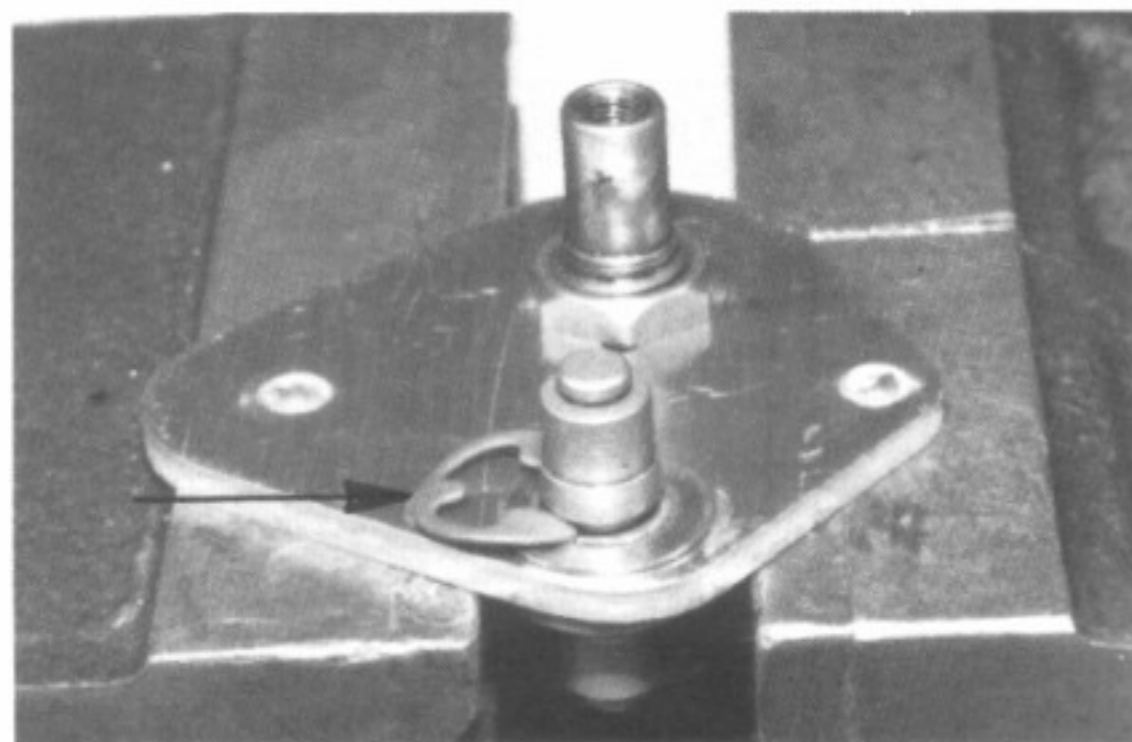

Fig. 34

□ **Fig. 35** Install the clip all the way on. Make sure that it is fully seated.

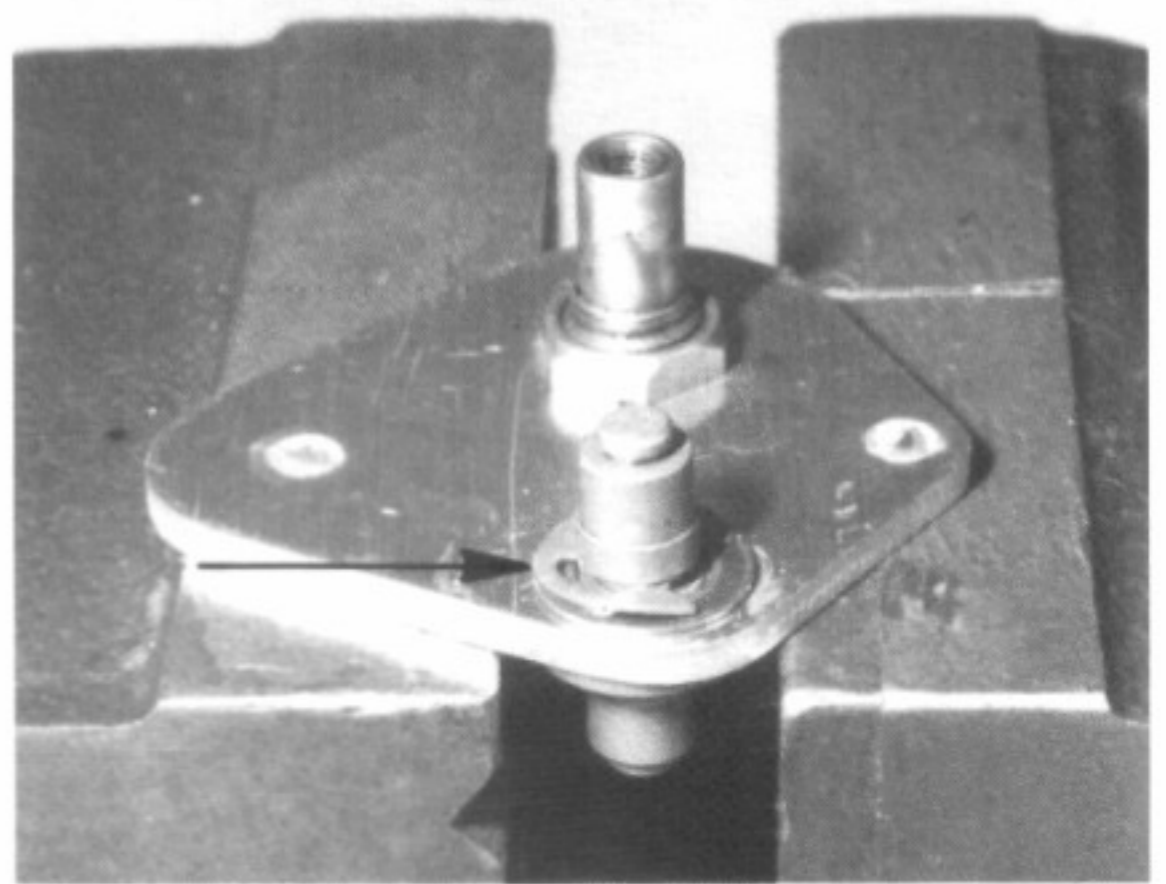

Fig. 35

□ **Fig. 36** Associated makes a complete ball bearing package for the RC10, part #6900. We'll show you how to install the bushings, which come with the kit, and the ball bearings. They're both installed in almost the same manner. If you are using bushings then wipe off the bushings and install them into the 2 #6612 axle drive gears. They are a snug fit so it will be necessary to tap them in with a soft blunt object such as a wood dowel. Make sure they are seated all the way in so that the snap ring groove in the gear is exposed.

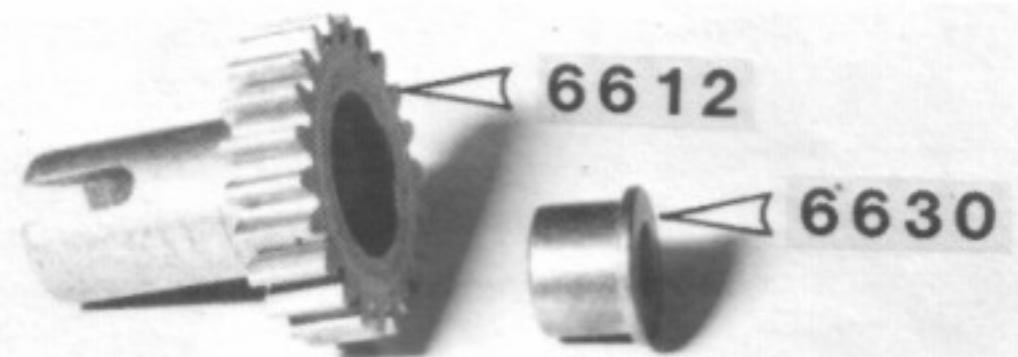

Fig. 36

□ **Fig. 37** If you have the ball bearing kit, install the small unflanged bearing #6901 first and then the #6902 flanged bearing.



Fig. 37

Fig. 38 Install the inside "C" clip.

Fig. 39 Make sure the clip seats all the way.



Fig. 38

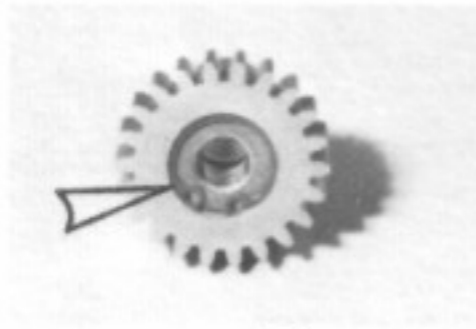

Fig. 39

Fig. 40 If you've installed ball bearings, now install the "C" clip.

Fig. 41 The installed clip should look like this.



Fig. 40

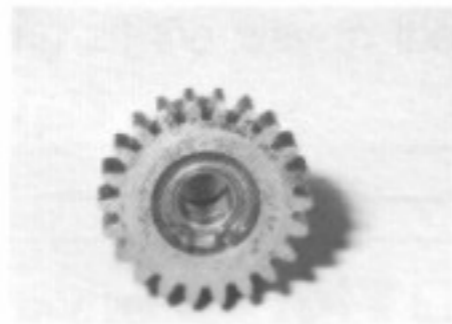

Fig. 41

Fig. 42 Now take the aluminum plate, and put a little oil on the bushing in one of the #6612 gears and install it onto the #6609 pivot, using one of the button head screws, as shown. Ball bearings will not require oiling.

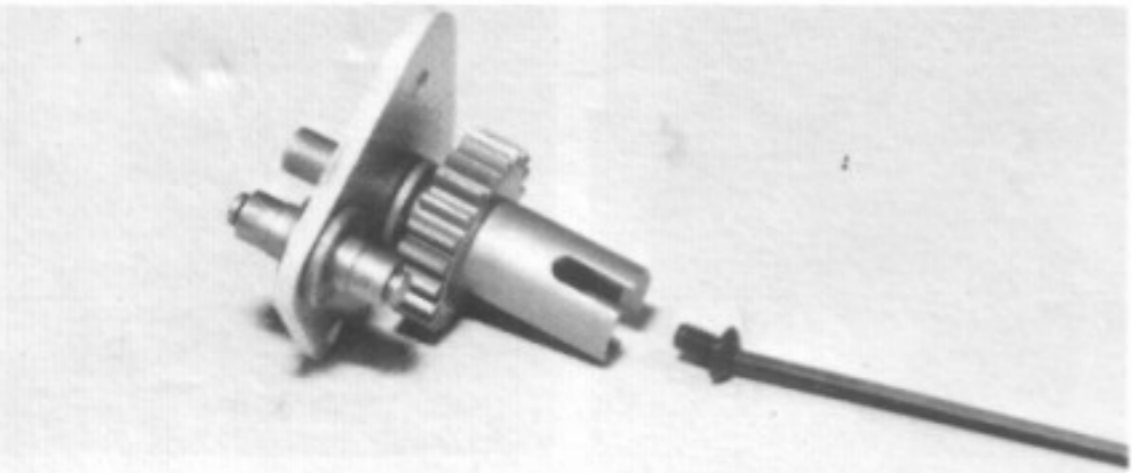

Fig. 42

Fig. 43 Turn the plate over and oil and install the other gear.

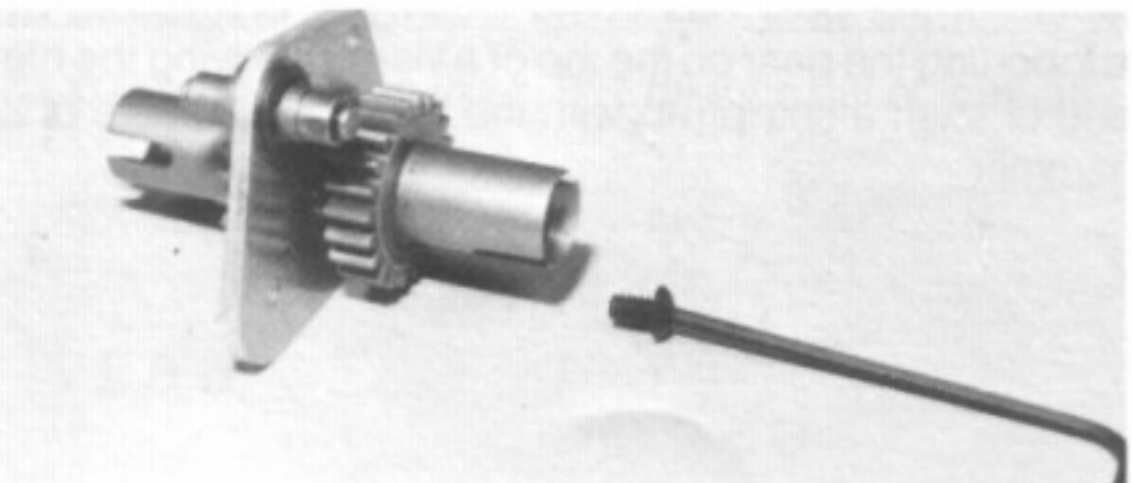

Fig. 43

Fig. 44 Take the 2 #6614 plastic gears out, and 2 of the short small bushings. With the flange of the bushing or ball bearing down flat against the table, hold the gear flat and push it down with your thumbs onto the bearing.



Fig. 44

Fig. 45 Install the bushings in the gears and then install the 4 small button head screws as shown. Only tighten the screws until they seat. Do not overtighten. Be careful because the screws are very small. If the wrench starts to slip it can be sharpened by cutting a small amount off the end with an abrasive cut-off wheel or grind stone.



Fig. 45

Fig. 46 The completed gear.



Fig. 46

Fig. 47 The ball bearing installs the same way.



Fig. 47

Fig. 47a Install the screws in the gear.

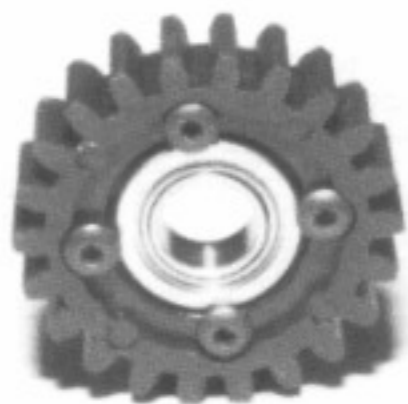

Fig. 47a

Fig. 49 Now oil the bushing and put the completed gear on the pivot pin on the aluminum spine plate.

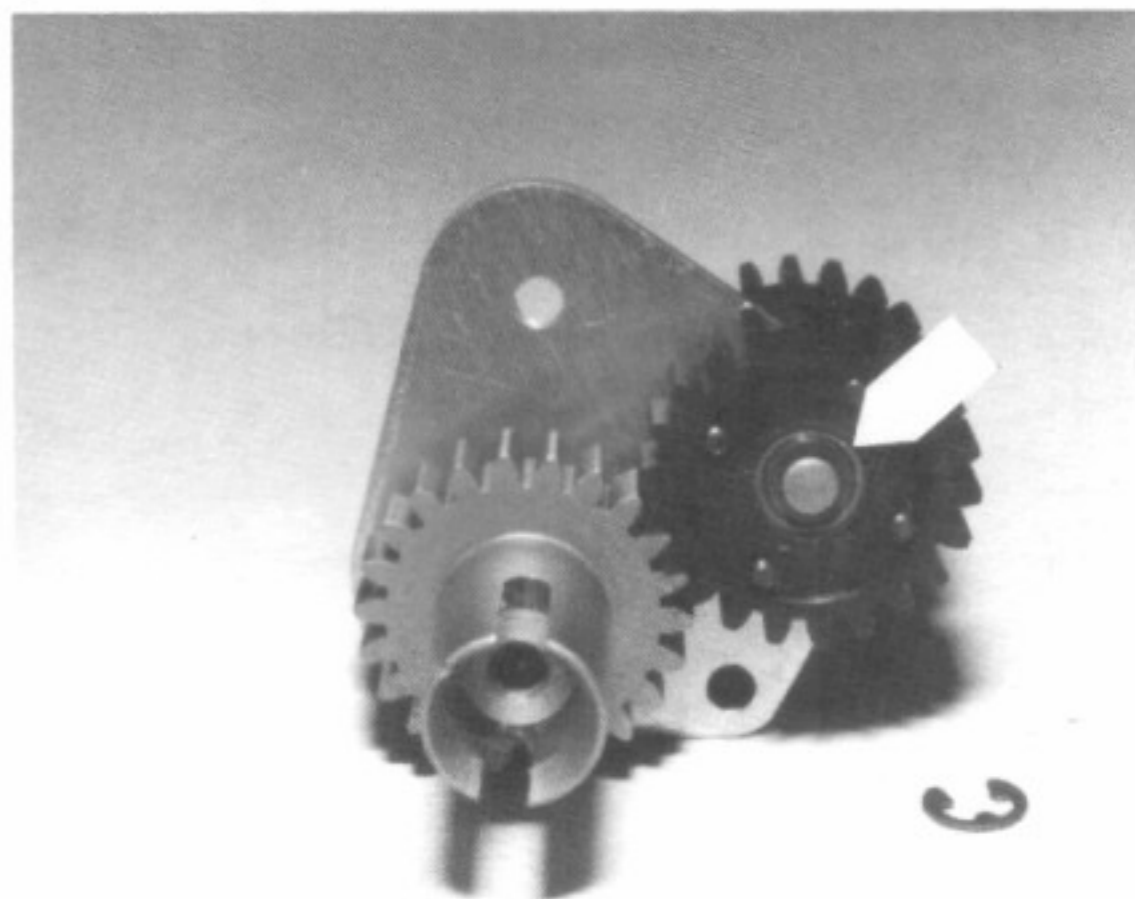

Fig. 49

Fig. 48 To lock the screws in, we recommend the use of pink ZAP. This is a cyanoacrylate adhesive. Put a VERY, VERY SMALL amount of ZAP on the end of an X-acto blade and put it on the bottom screw as shown. Now rotate the gear and put it on the 2nd screw, which will now be in the bottom position. This way if you get too much ZAP on, it will run down away from the bearing and not on the bearing. Do all 4 screws this way, on both gears.

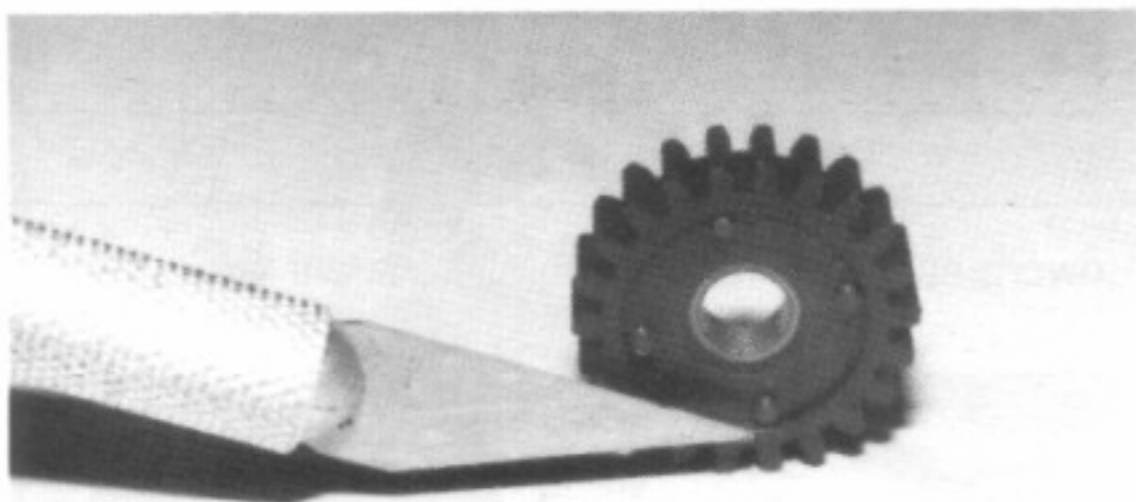

Fig. 48

Fig. 50 Oil and put the 2nd gear on and install both "E" clips.

Fig. 51 Rotate both L.H. and R.H. gear sets. They should both rotate very freely. If they do not rotate freely, you probably don't have one of the pivot pins installed properly in the aluminum plate. (Those flanges MUST be flush and even against the plate!) You can also try lifting and rotating the plastic gear a few teeth before remeshing. You may find a position where they are the smoothest.



Fig. 50

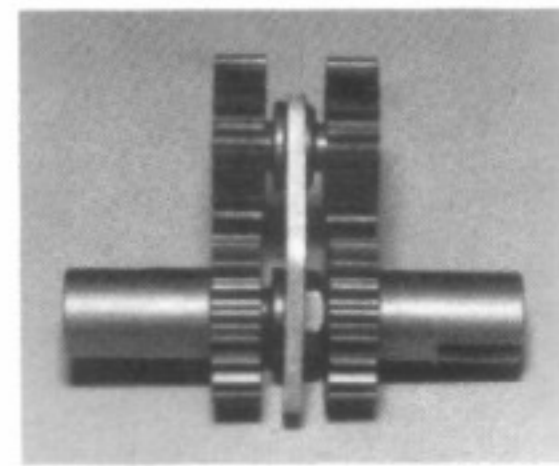

Fig. 51

Fig. 52 Now take the #6618 differential shaft with gear, and the thick thrust washer with the small hole from the same small bag. The gear is locked to the shaft on a taper. If the gear has come loose you can reset by supporting the gear on the top of a vise and giving the big end of shaft a sharp rap with the WOODEN handle of a hammer.

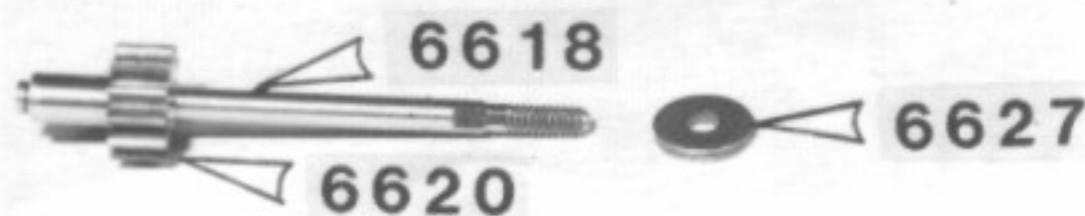

Fig. 52

Fig. 53 Slip the washer on the shaft. Slip the blue thrust bearing on, as shown. Now set this shaft aside until we do step #65.

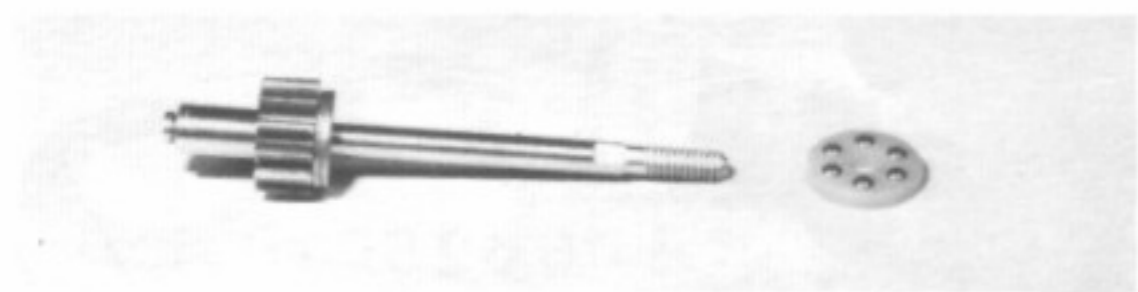

Fig. 53

Fig. 54 Take one of the #6606 bearing adaptors out of bag #6-12 and one of the narrow bushings with a 1/4" dia bore.

Fig. 55 Install the bushing all the way in the adaptor, as shown.

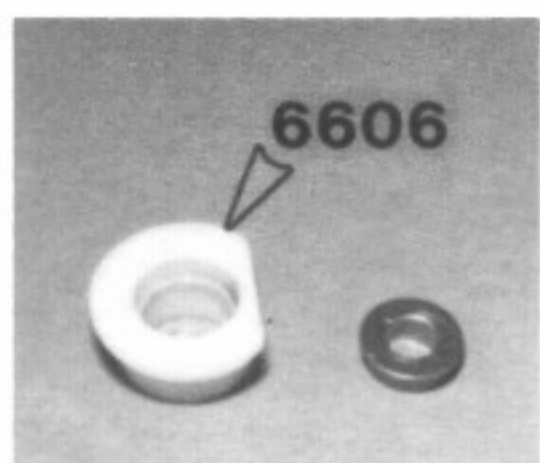

Fig. 54

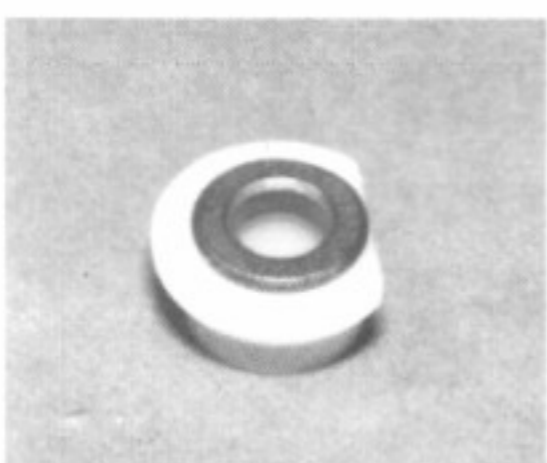

Fig. 55

Fig. 56 If you're installing ball bearings, install it in the adaptor.

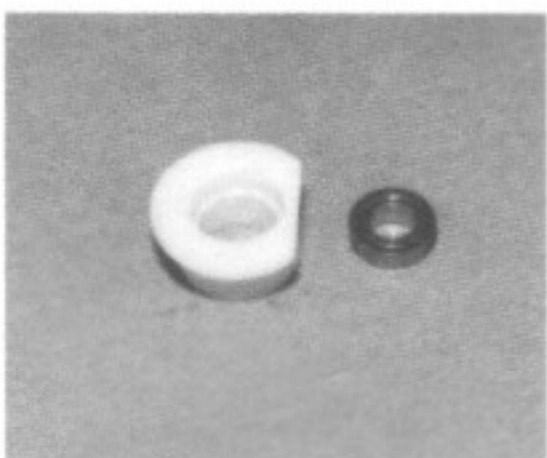

Fig. 56

Fig. 57 Take the #6617 dif tube out of the bag.

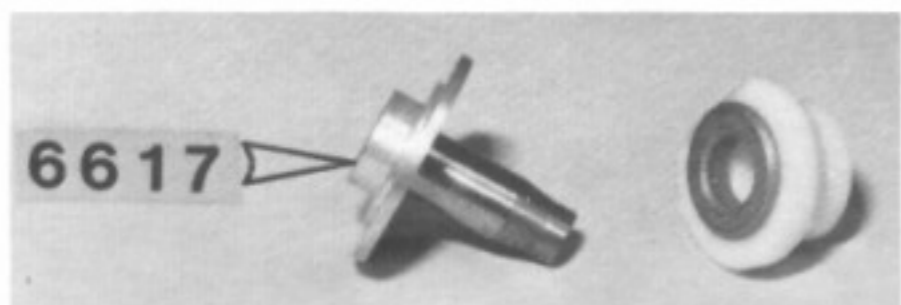

Fig. 57

Fig. 58 Oil the bushing and slip it on the dif tube, as shown, or install a ball bearing.

Fig. 59 Take the #6621 dif pinion gear out of the bag.



Fig. 58

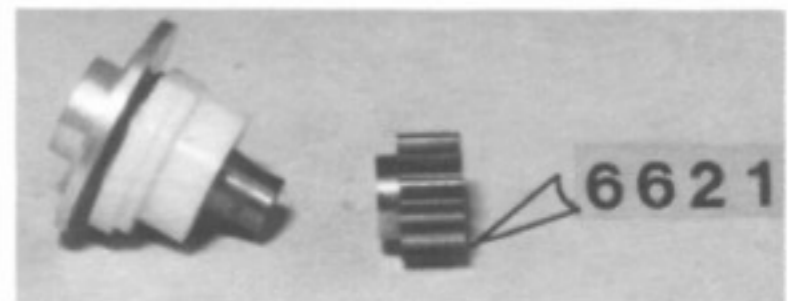

Fig. 59

Fig. 60 Slip the gear onto the tube and tap the assembly together using the plastic handle of a screwdriver. DO NOT use a vise to squeeze it on. The gear does NOT go all the way on. There should be enough room left in the gear (.100 or 2.5mm) to install the Teflon bushing shown in Fig. 65.

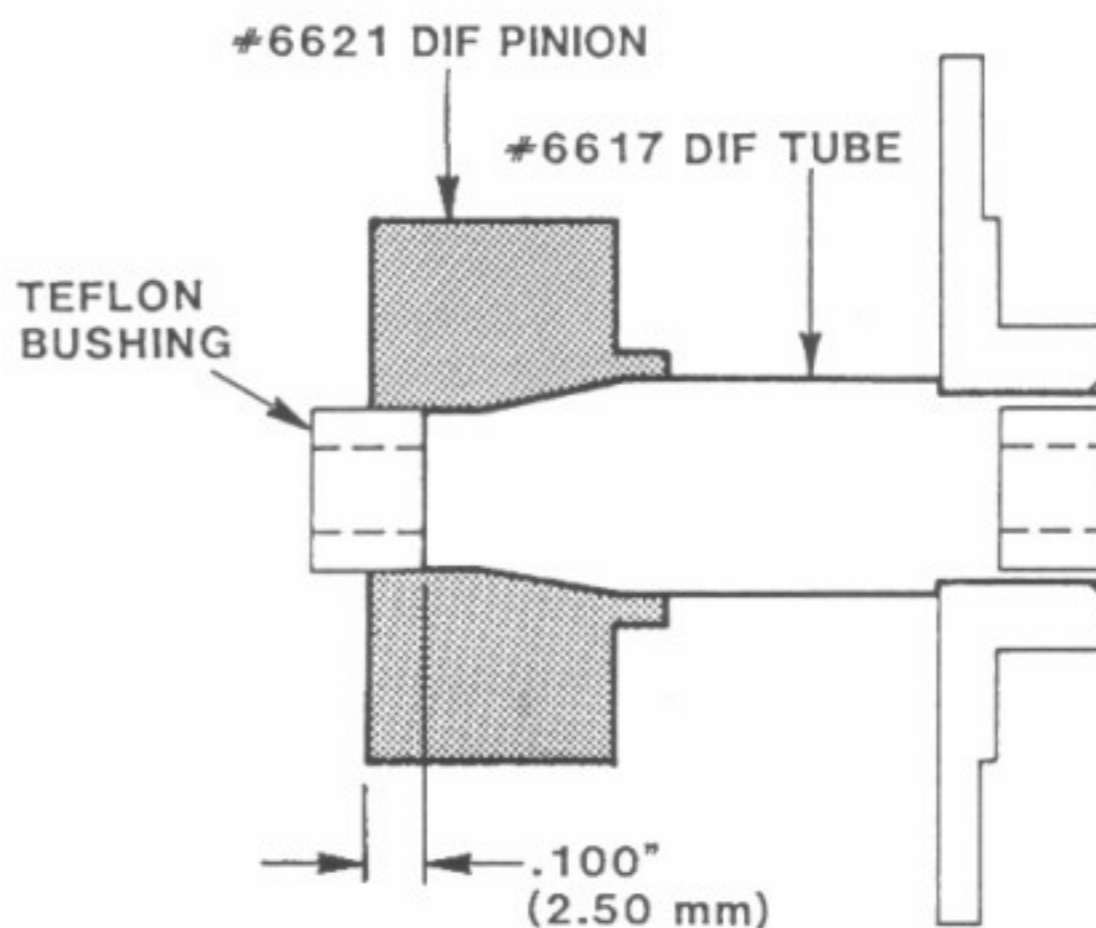

Fig. 61 Take one of the #6623 small white Teflon bushings out.

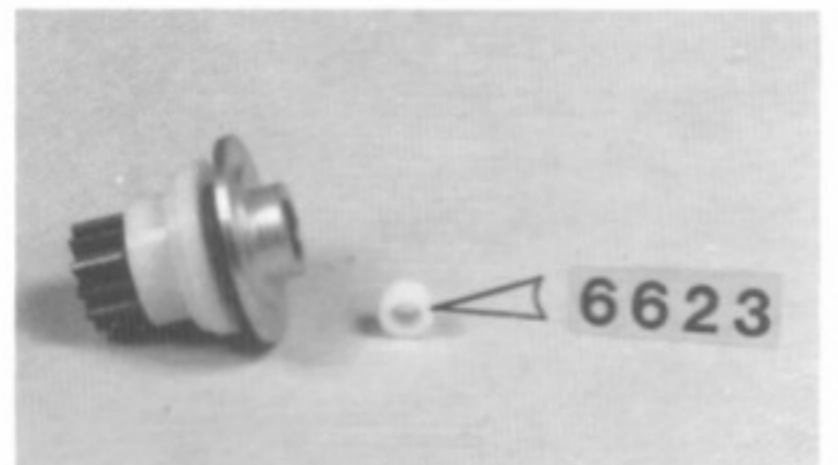

Fig. 61

Fig. 62 You should be able to push the bushing into the tube with your finger.

Fig. 63 Now take the other #6623 bushing and the other thick thrust washer out. Push the bushing inside the washer. The bushing should be inside the dif tube with the washer on the outside of the bushing.

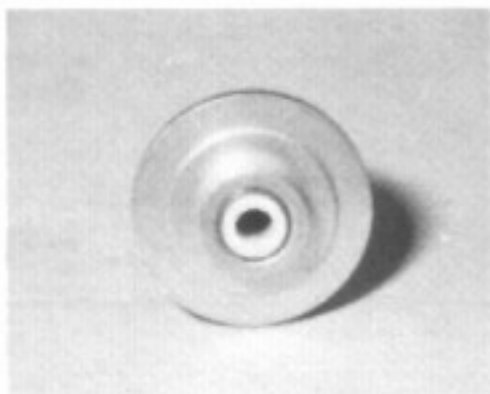

Fig. 62

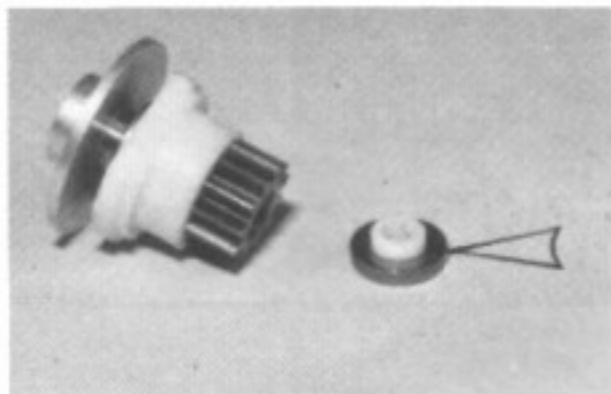

Fig. 63

Fig. 64 Push the bushing into the dif tube, as shown.

Fig. 65 Now slip the dif tube assembly onto the dif shaft, as shown.



Fig. 64

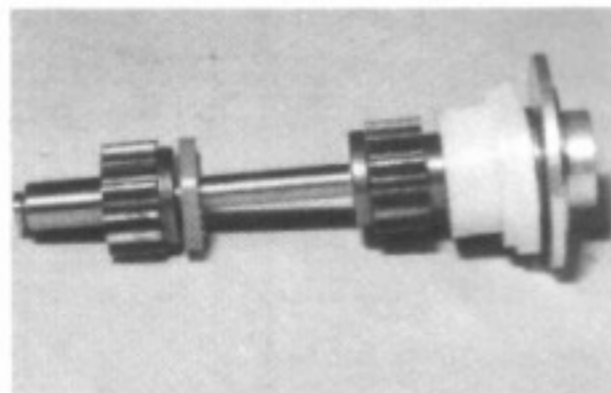

Fig. 65

Fig. 66 The dif tube assembly should spin freely on the dif shaft. If not, the Teflon bushings might not be centered correctly. Check this, and use the shaft to help center the bushings.

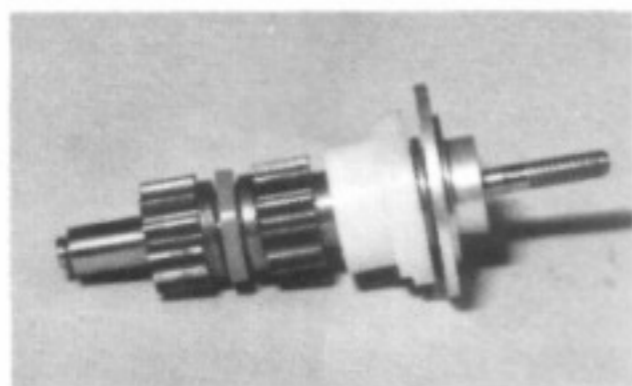

Fig. 66

Fig. 67 Take one of the #6625 dif drive rings out of the bag.

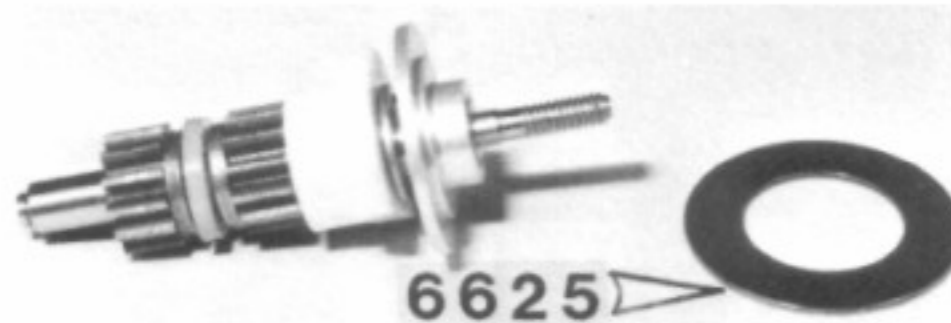

Fig. 67

Fig. 68 Slip the ring on the hub, as shown.

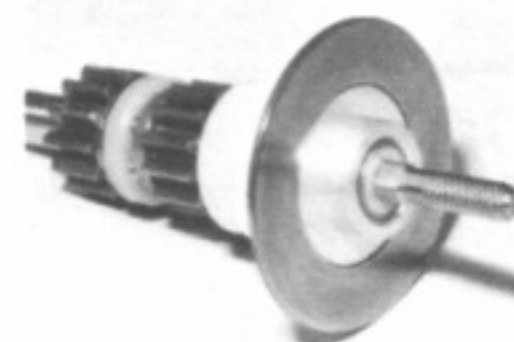

Fig. 68

Fig. 69 Take the #6626 balls out of the bag. In bag #6-15, take the plastic spur gear.

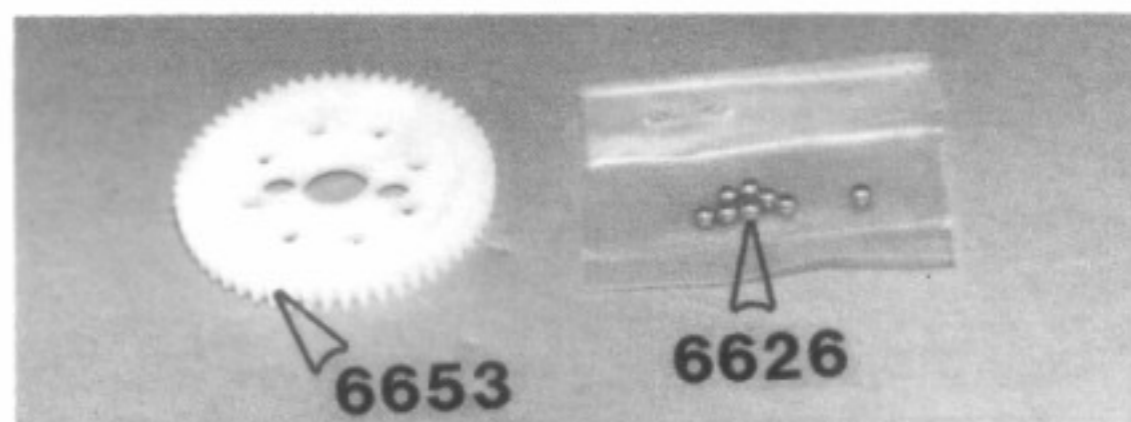

Fig. 69

Fig. 70 Push the 8 balls into the square holes in the gear as shown.

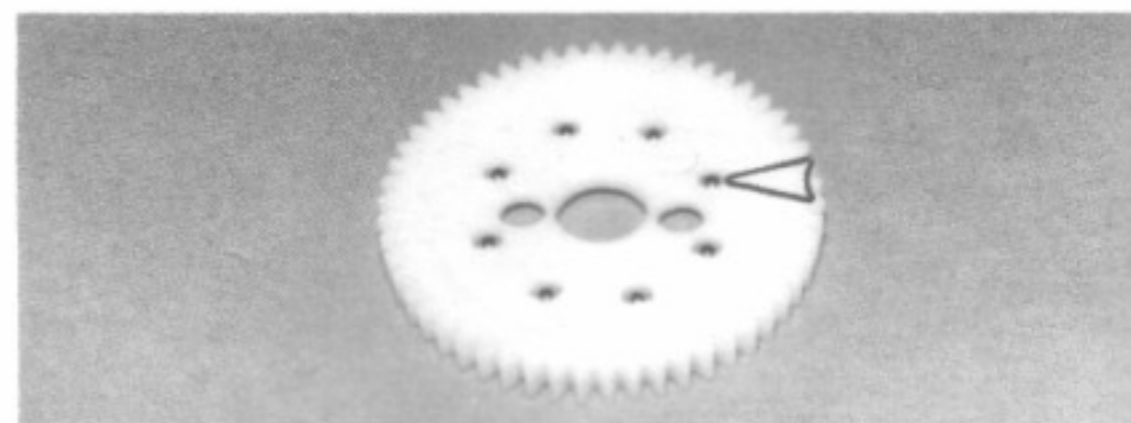

Fig. 70

Fig. 71 Take the #6636 Associated dif lube.

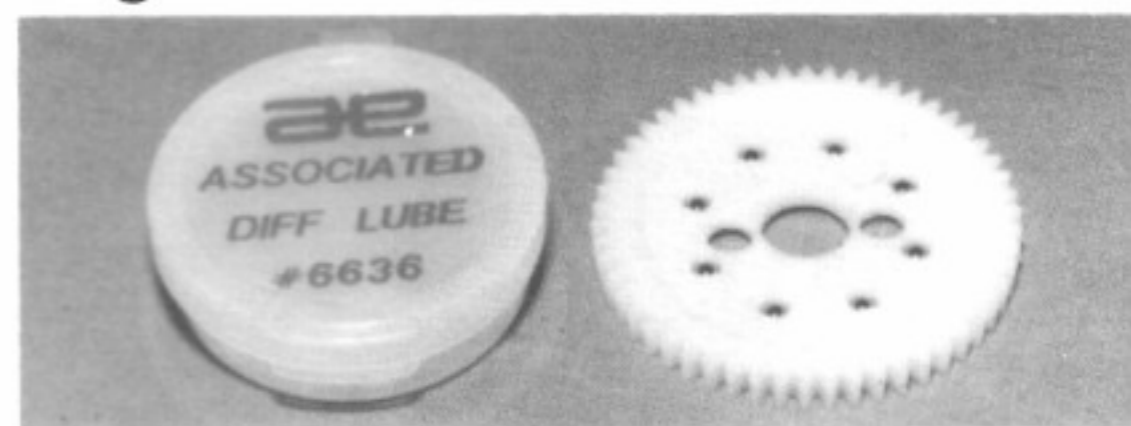

Fig. 71

Fig. 72 Apply a small amount of this special lube to the balls on both sides of the gear. NEVER use any other type of lube on the balls, otherwise the dif will slip.

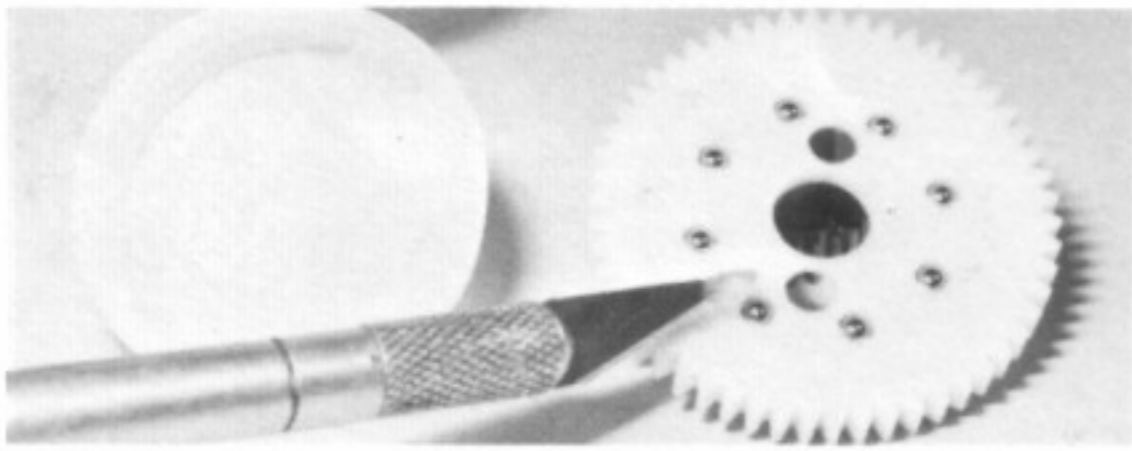

Fig. 72

Fig. 73 Apply a small amount of the #6636 Associated dif lube to the center hole of the gear. DO NOT use this dif lube anywhere else on the car for metal to metal lubrication. (It's intended as a plastic to metal or plastic to plastic lubricant.)

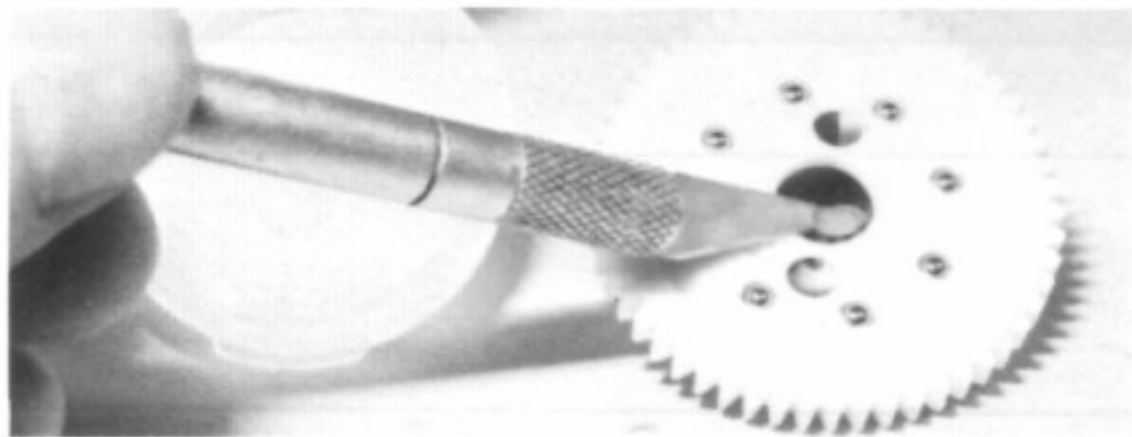

Fig. 73

Fig. 74 Take the dif shaft assembly and spur gear.

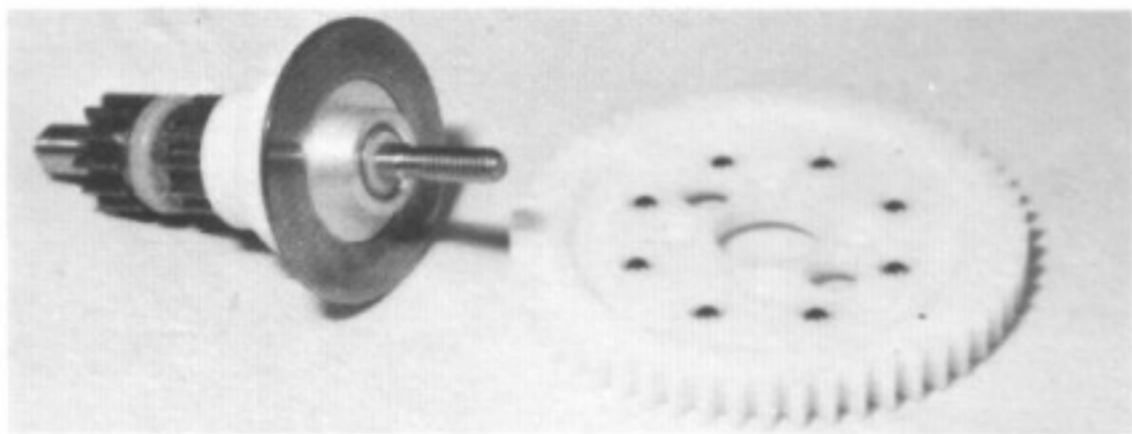

Fig. 74

Fig. 75 Slip the spur gear on the shaft. Take the other drive ring.

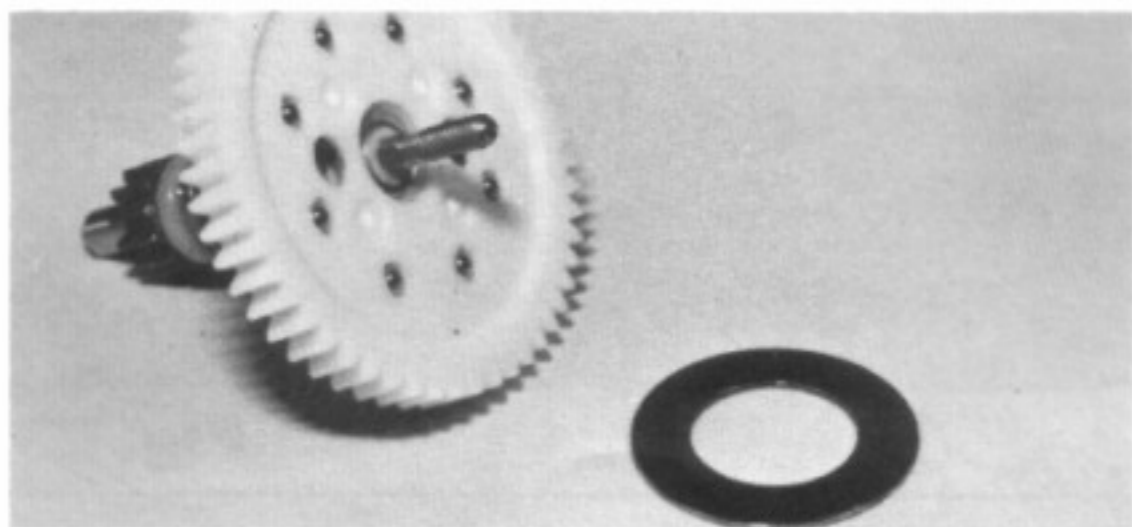

Fig. 75

Fig. 76 Slip the drive ring on the shaft and take the #6624 dif outer hub.

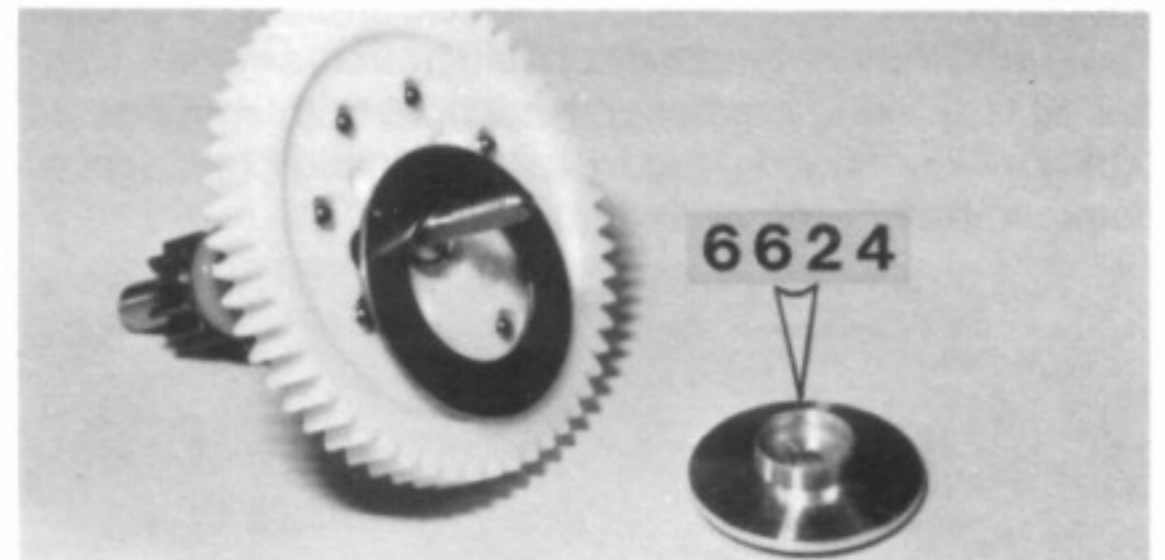

Fig. 76

Fig. 77 The outer dif hub has a notched hole to match the flat spots on the shaft. Align the two and slip the hub on the shaft. Check that both drive rings are centered and seated against the aluminum hubs. Take out the #6628 dif spring and nut.

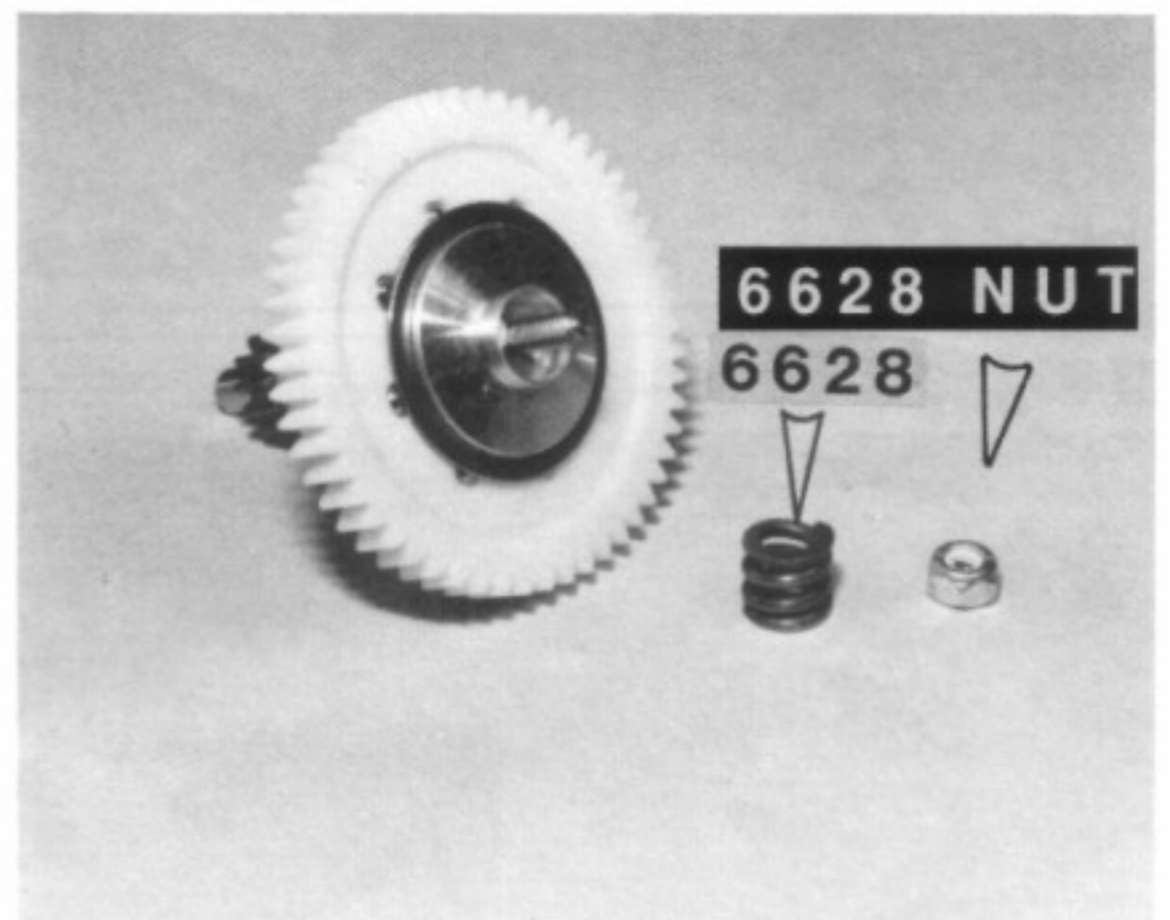

Fig. 77

Fig. 78 Slip the spring on and screw the nut on. You'll have to hold the small gears from turning while screwing the nut on. Screw the nut on until the end of the nut is even with the end of the shaft, as shown.

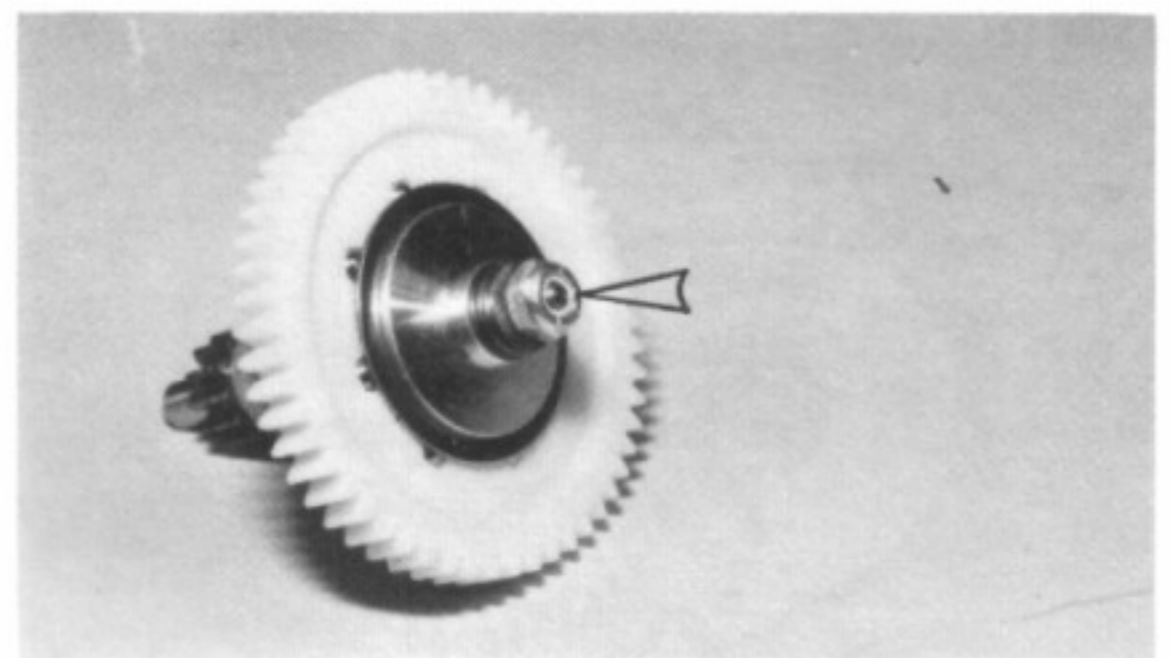

Fig. 78

□ **Fig. 79** Hold the dif assembly in your hands, as shown. Hold the outside small gear still, and slowly rotate the big plastic spur gear. The inside small gear should rotate, and the whole rotation should be very smooth. Then the dif is working correctly. Now hold both small gears tightly in your fingers, and try to turn the big plastic gear. It should be VERY HARD to turn.

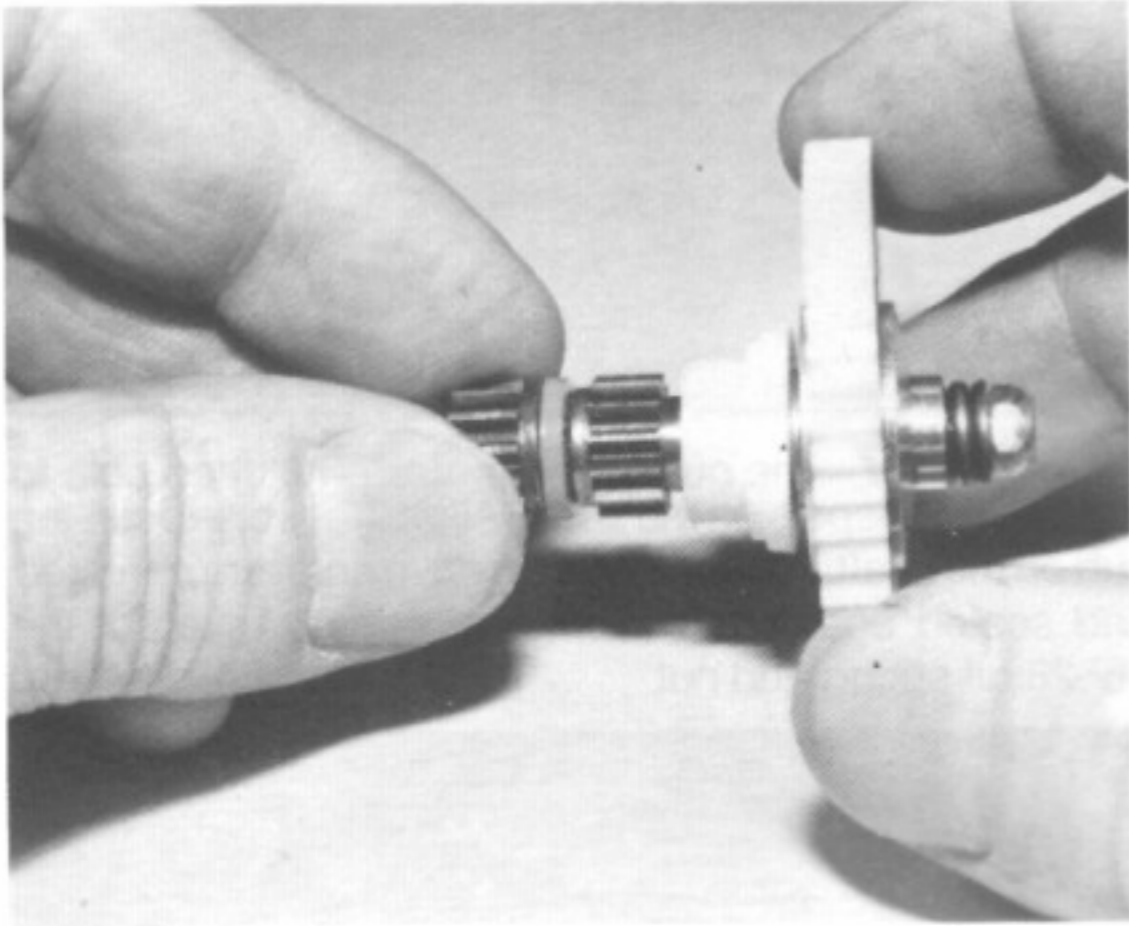

Fig. 79

□ **Fig. 80** Take the #6607 motor mount out.

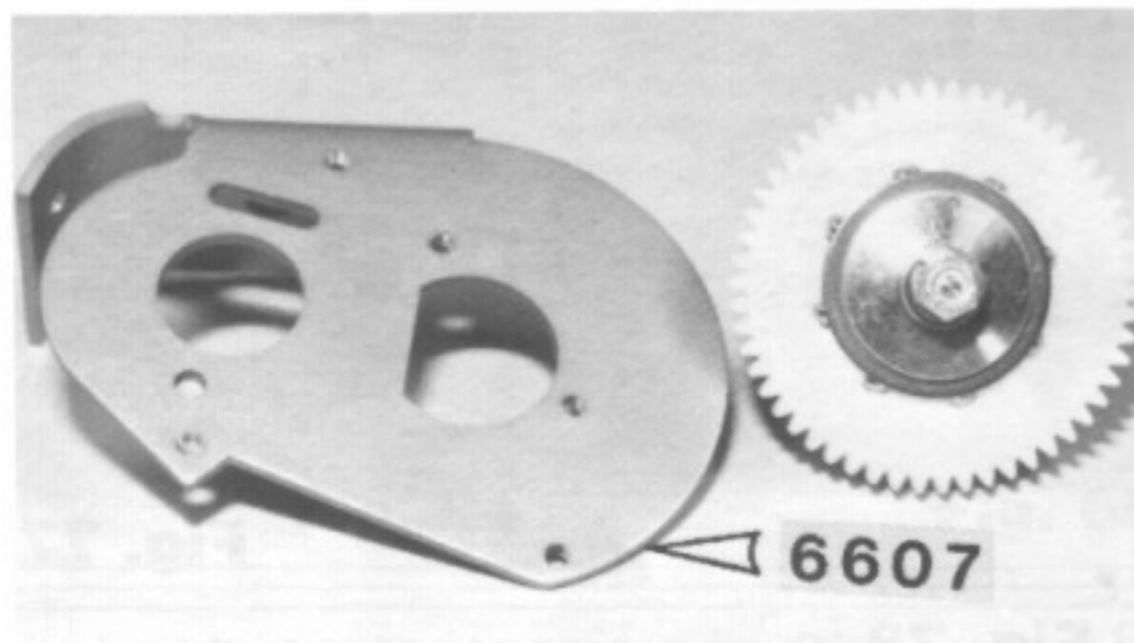

Fig. 80

□ **Fig. 81** Slip the dif into the motor mount, as shown.

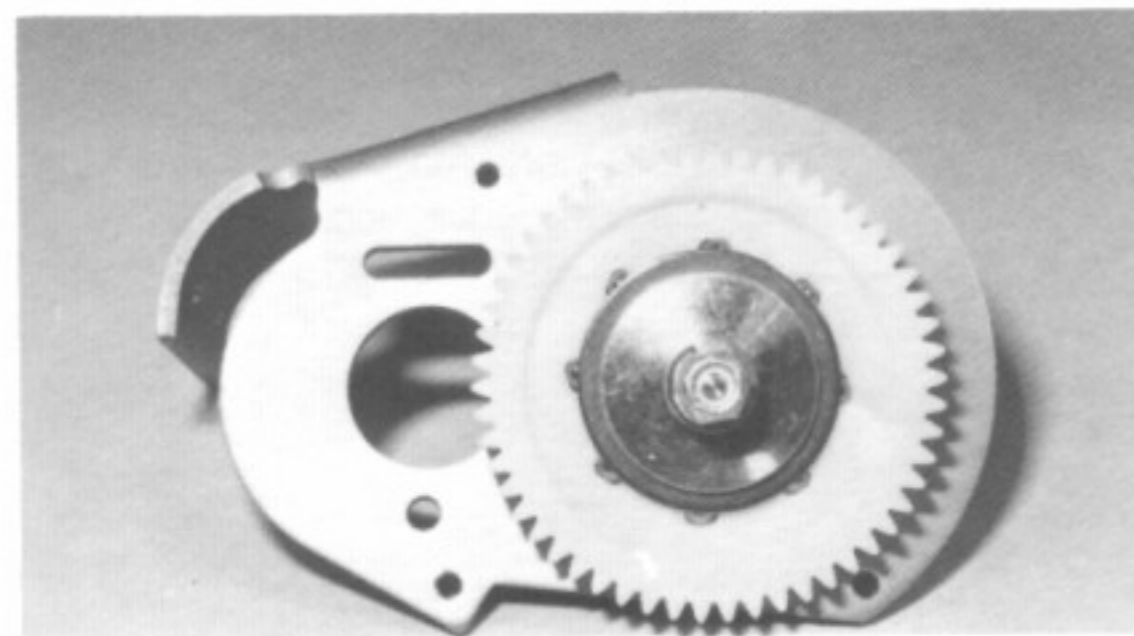

Fig. 81

□ **Fig. 82** Make sure the bearing adaptor is properly seated in the motor mount. Take out the #6605 transmission housing, as shown.

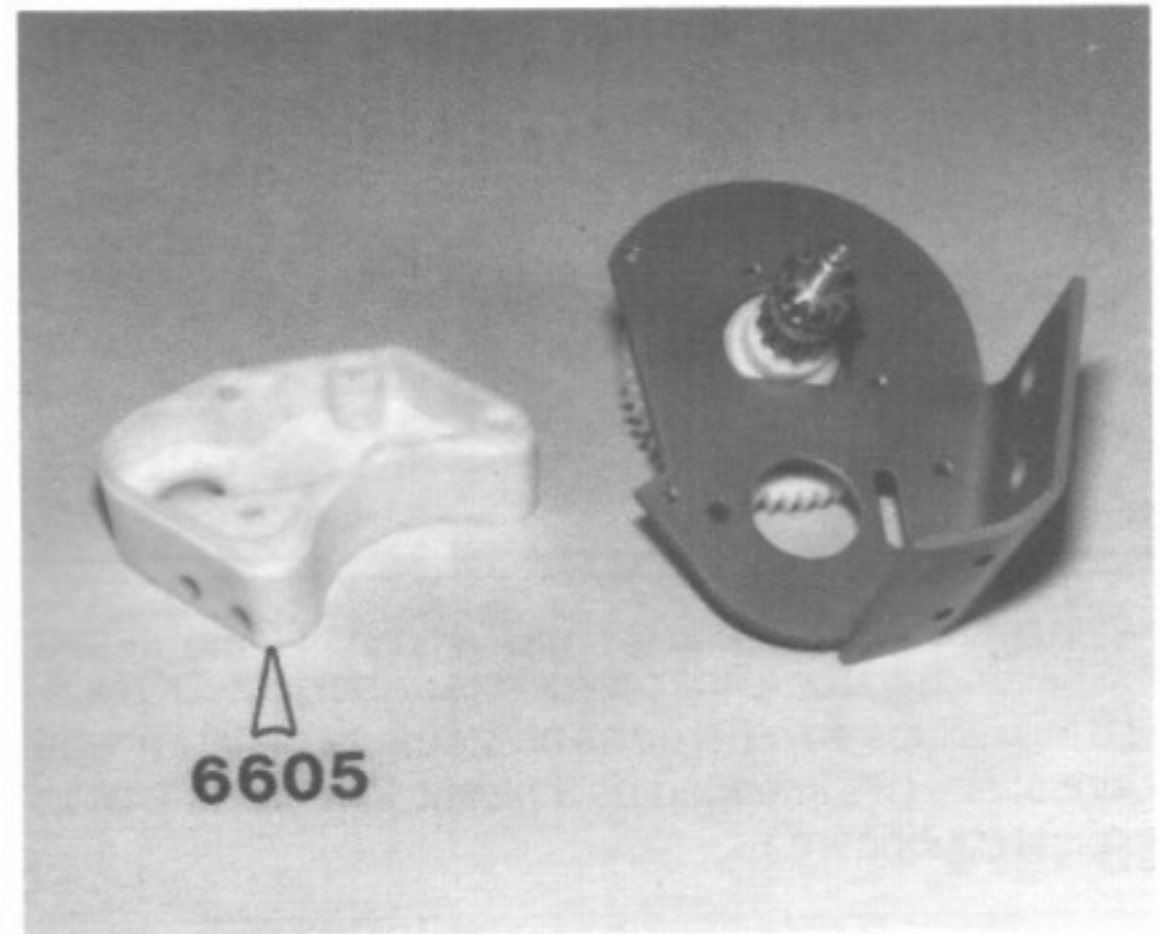

Fig. 82

□ **Fig. 83** Slip the R.H. half of the housing onto the dif.
NOTE: There is a flat on the adaptor that MUST match a flat in BOTH the motor mounting plate and the transmission case. The adaptor is a tight fit in the transmission case, so you'll have to work to get it started. If you have installed it properly the adaptor will be in far enough to be flush on the inside of the case half-shell. The motor plate will be loose for the next 9 steps.



Fig. 83

Fig. 84 Take the idler gear assembly.

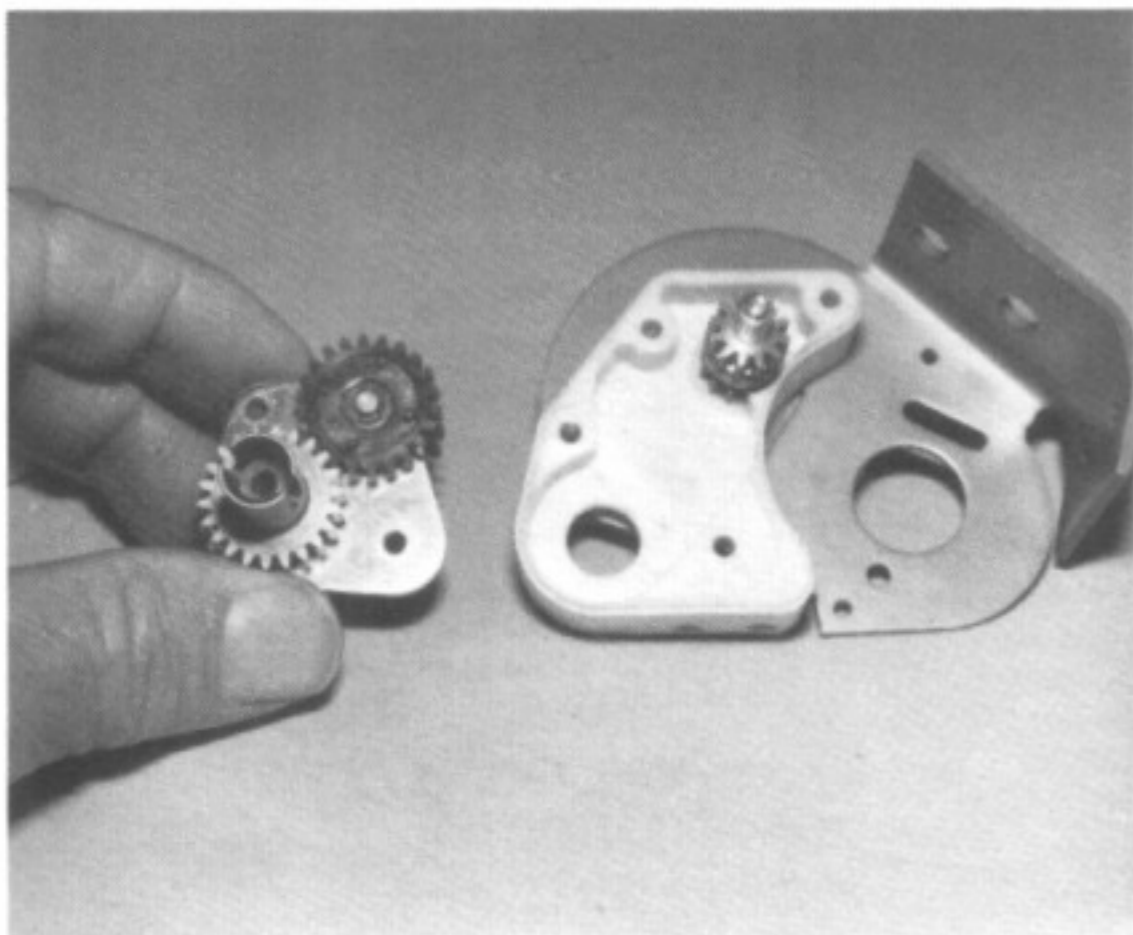

Fig. 84

Fig. 86 Take the L.H. side of the housing and push it onto the R.H. side. It will snap together with finger pressure.

NOTE: The seam between the two halves of the case should close completely with no more than a few thousandths of an inch gap showing (usually on the bottom of the case). If you cannot close the case completely look for something wrong inside.

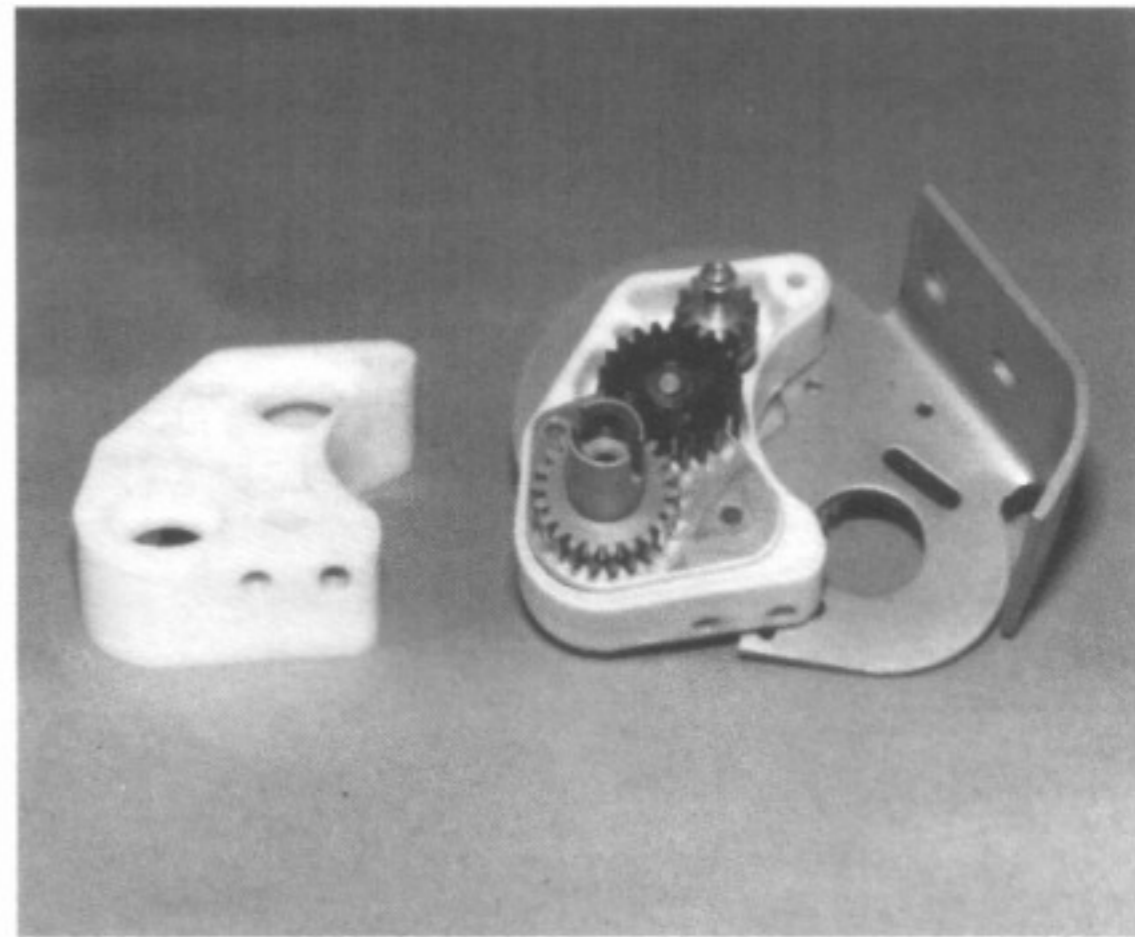

Fig. 86

Fig. 85 Set the idler gear assembly into the housing, as shown.

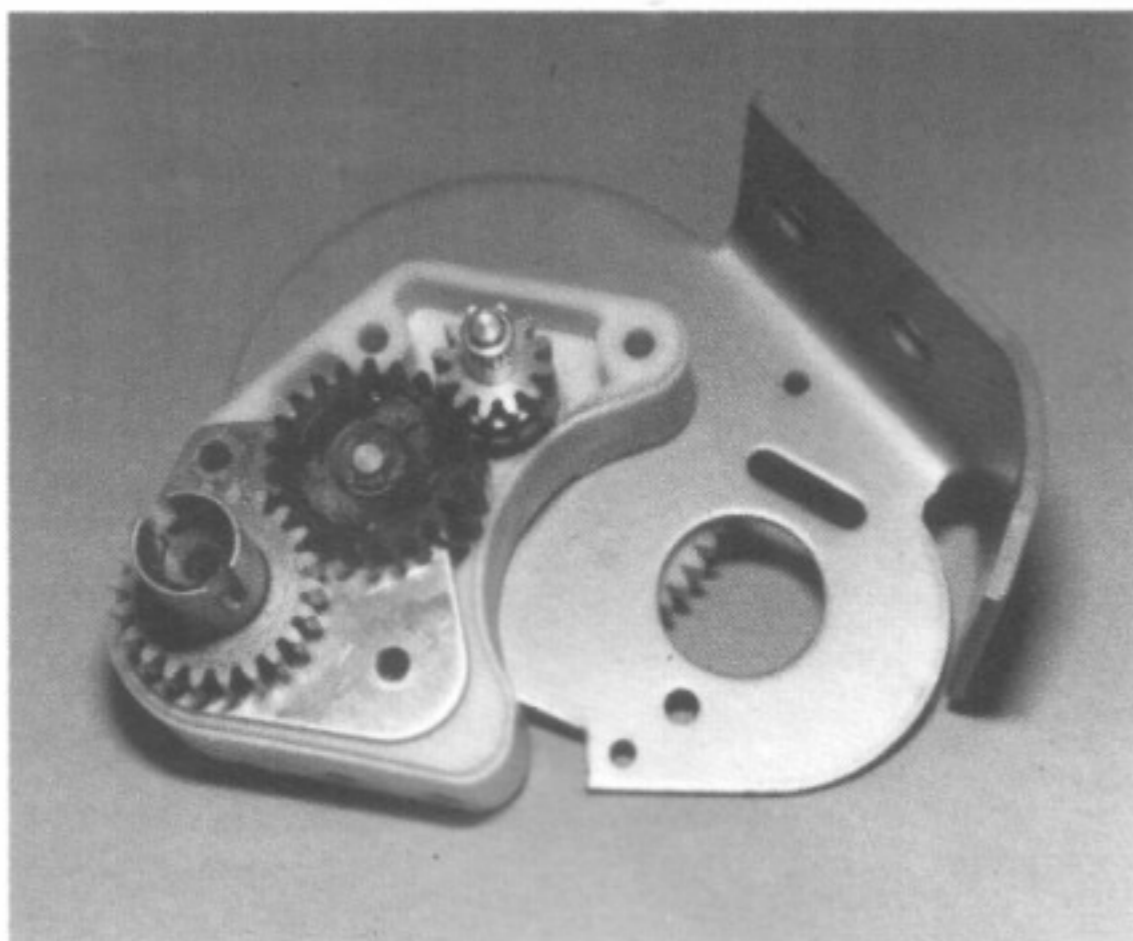

Fig. 85

Fig. 87 Take the other bearing adaptor and cut a small notch in the edge, as shown. This will make installing and removing the "E" clip a lot easier.

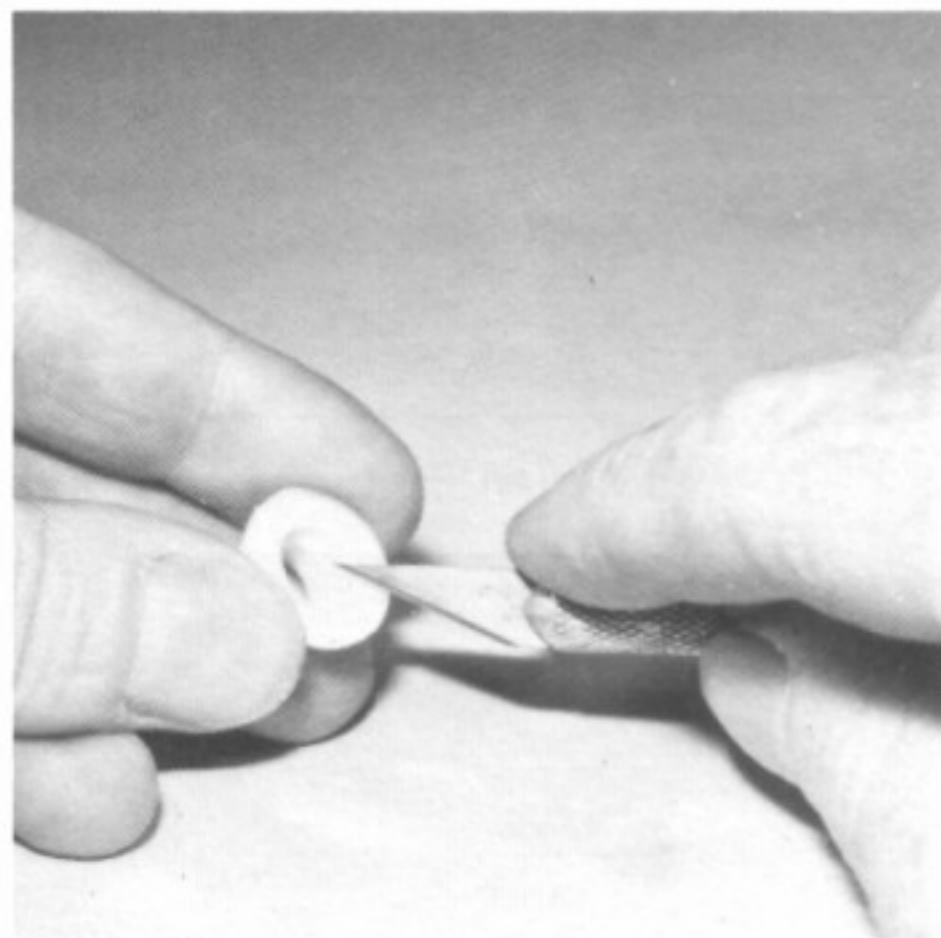

Fig. 87

Fig. 88 Install the bushing or ball bearing into the adaptor.

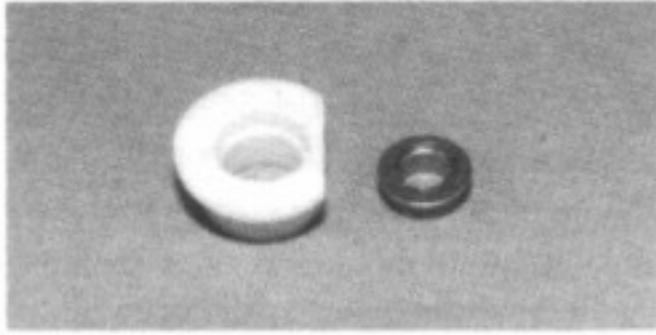

Fig. 88

Fig. 89 Oil and install the adaptor onto the dif shaft.

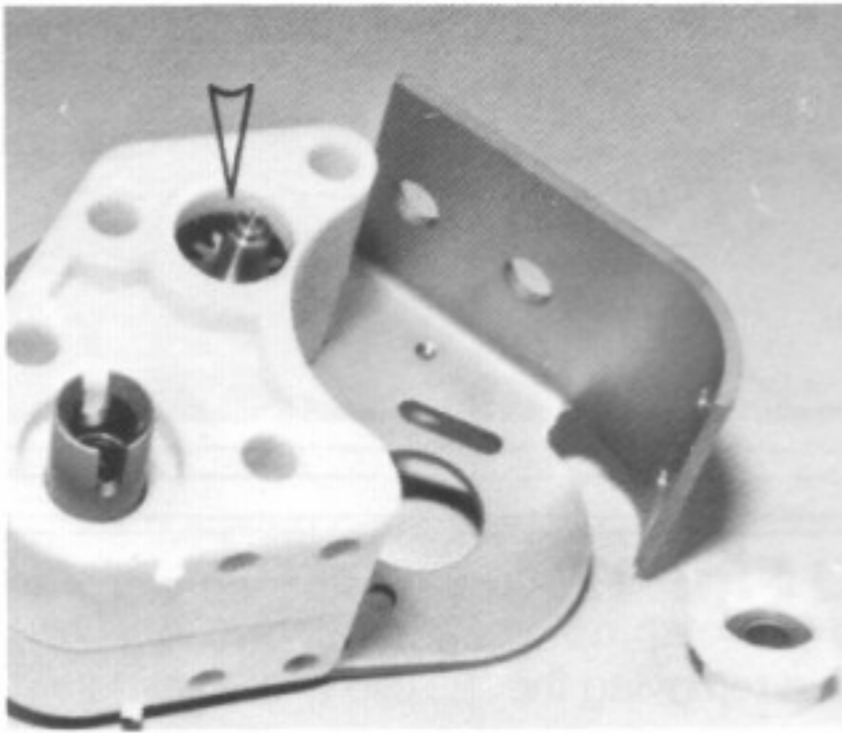

Fig. 89

Fig. 90 Install an "E" clip on the end of the dif shaft.

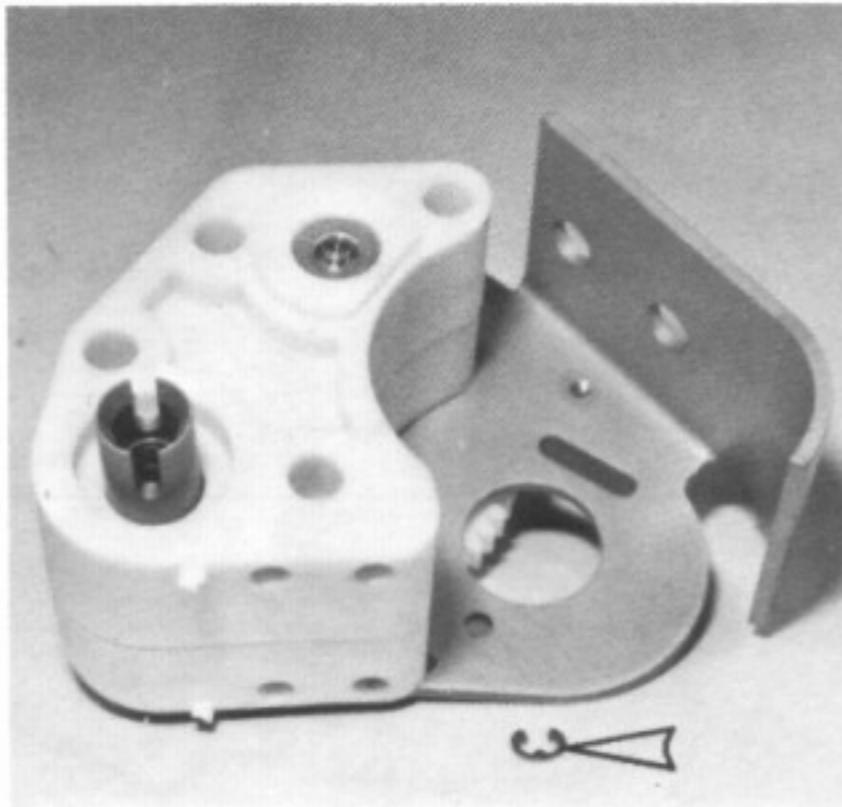

Fig. 90

Fig. 91 Make sure the "E" clip is seated correctly.

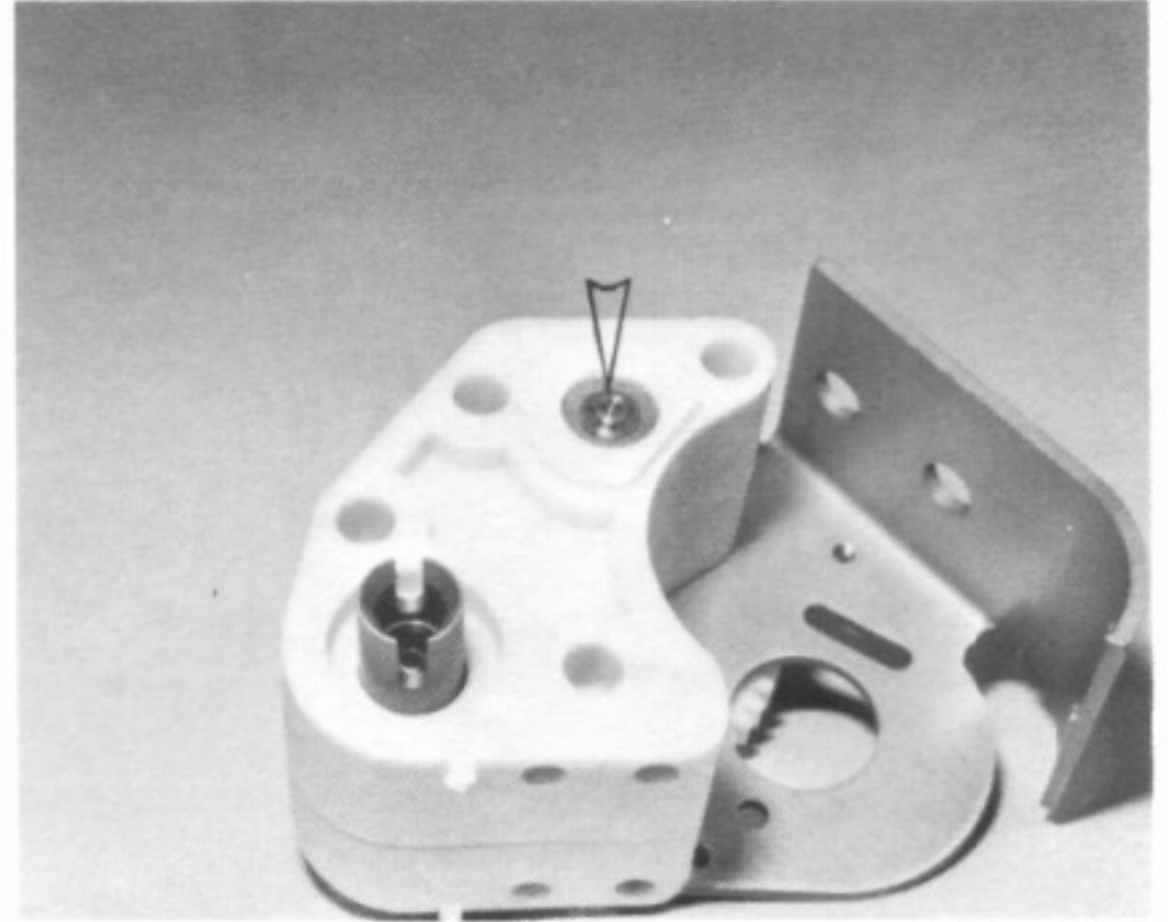

Fig. 91

Fig. 92 Take the 3 long Allen screws, as shown, and screw them into the motor mount.

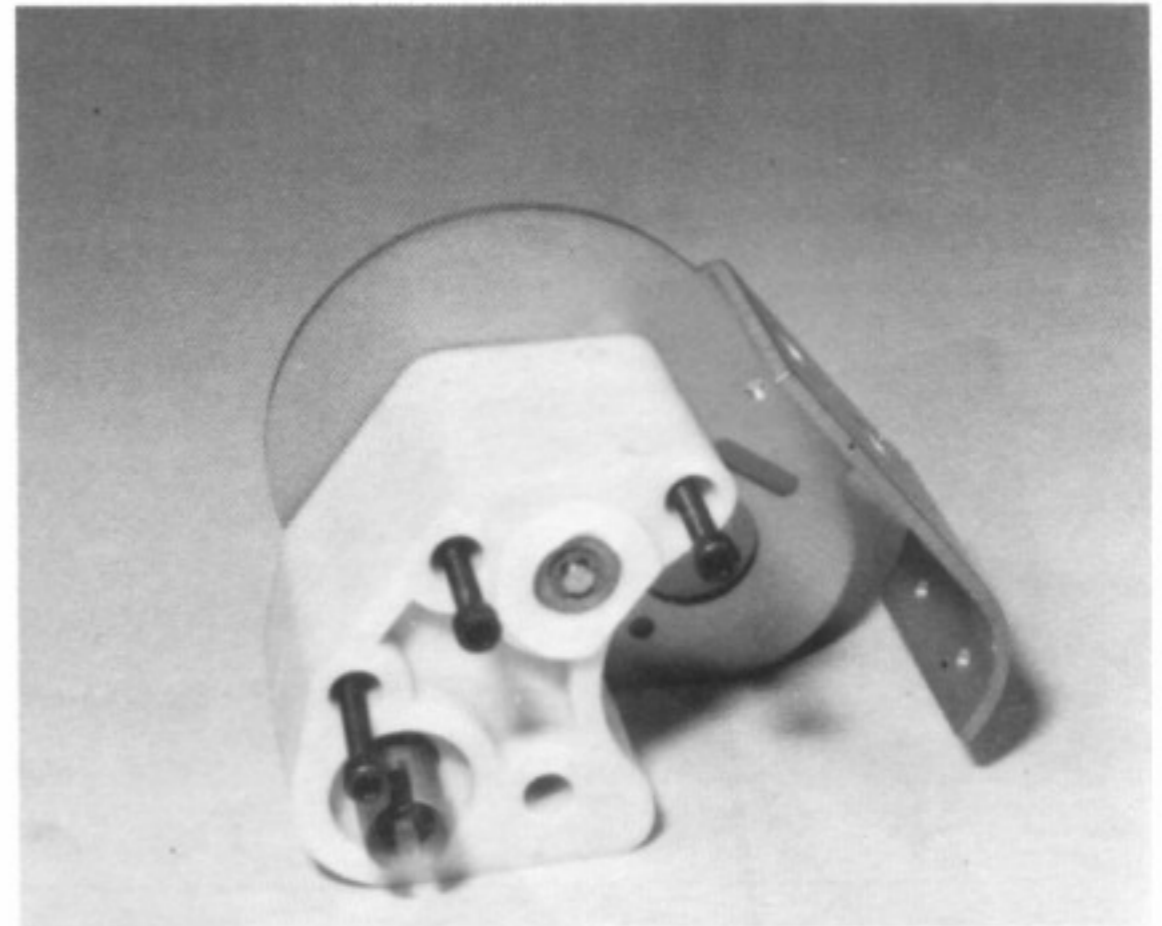

Fig. 92

□ **Fig. 93** Take the other short screw, then slip a 4/40 nut into the hex hole, as shown, and tighten this screw.

NOTE: After assembling the transmission with bushings for the first time the large gear may be hard to turn. You can free things up by giving a sharp blow to each END of the dif shaft using the plastic handle of a screwdriver as a hammer. A few raps on the adjustment nut followed by a few against the adaptor on the other side will help to align the bushings. Once you start running the car the bushings will free up completely.

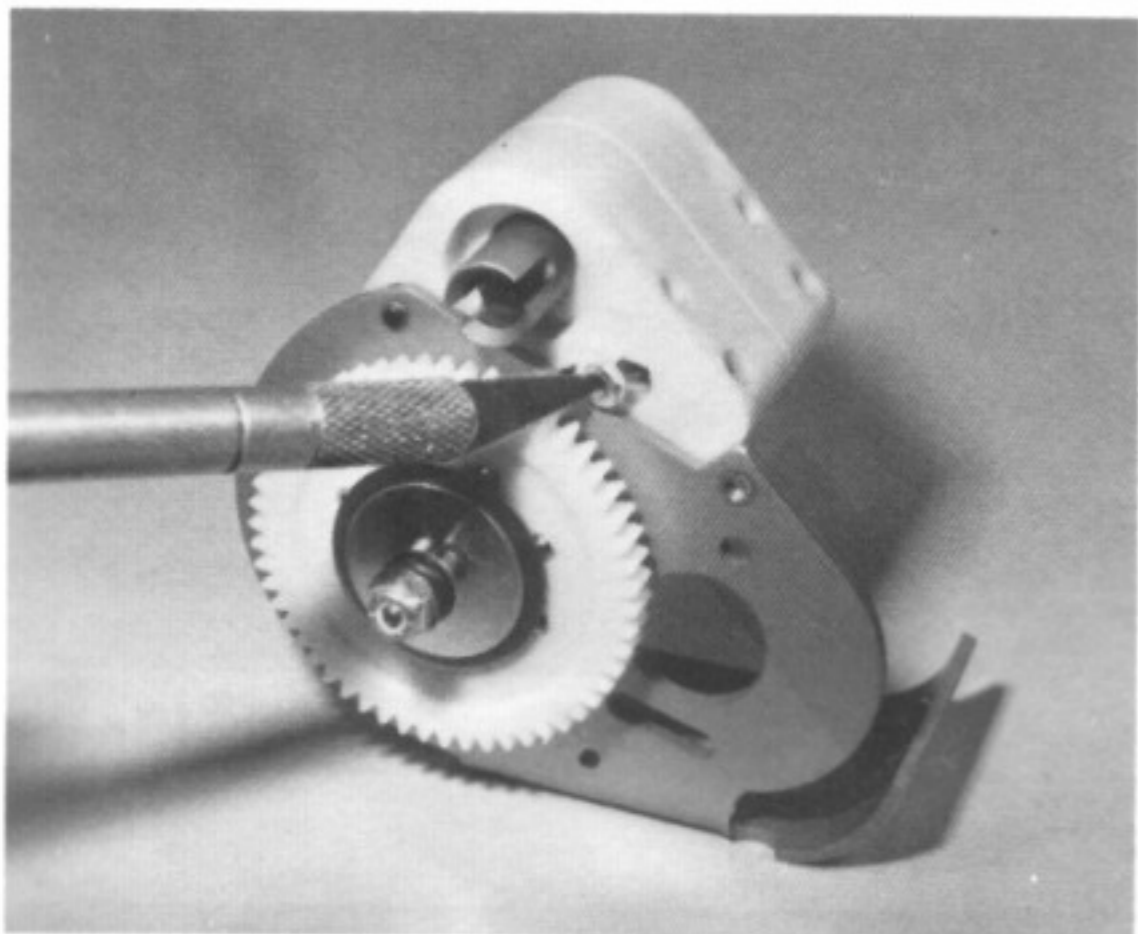

Fig. 93

□ **Fig. 94** On the bottom of the transmission case, as shown, are 2 molding lugs. Cut these off flush with an X-acto knife.

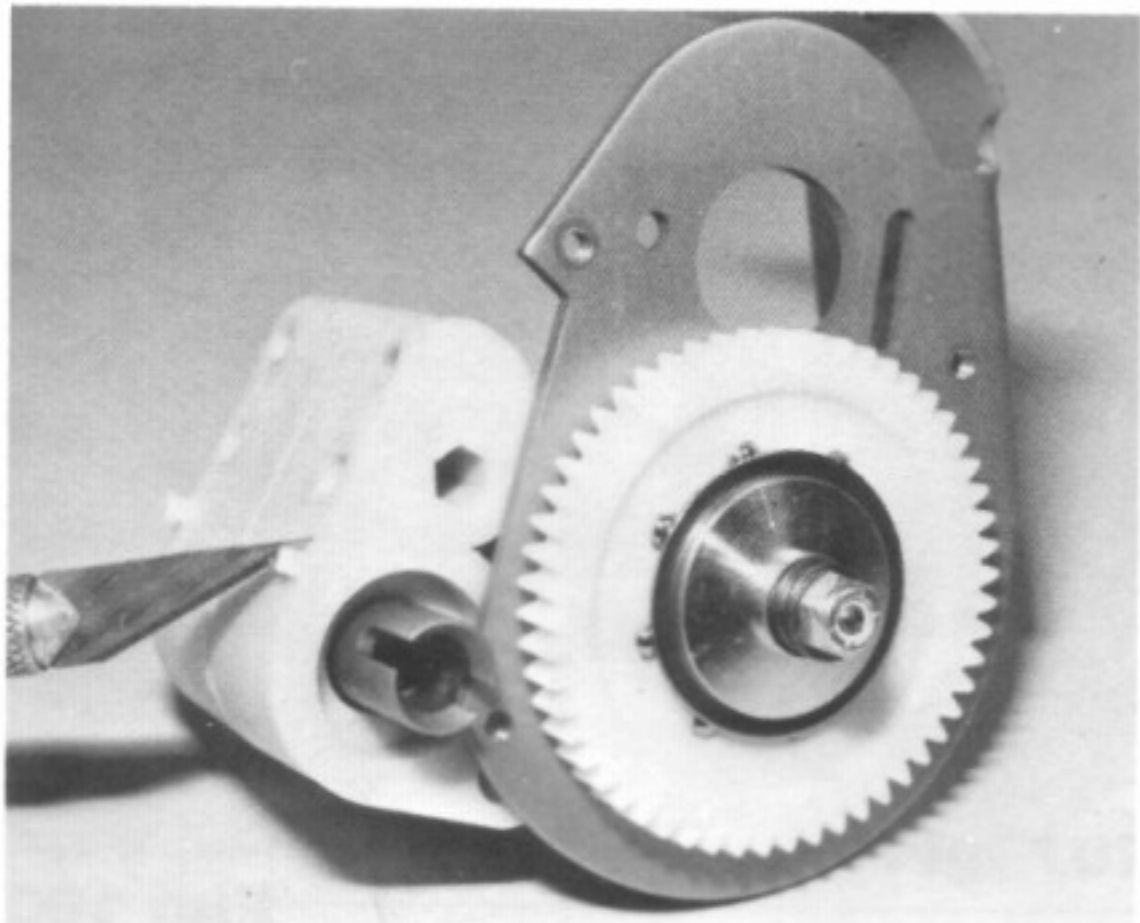

Fig. 94

□ **Fig. 95** Take the 2 #6633 felt seals out and slip them on the hubs, as shown.

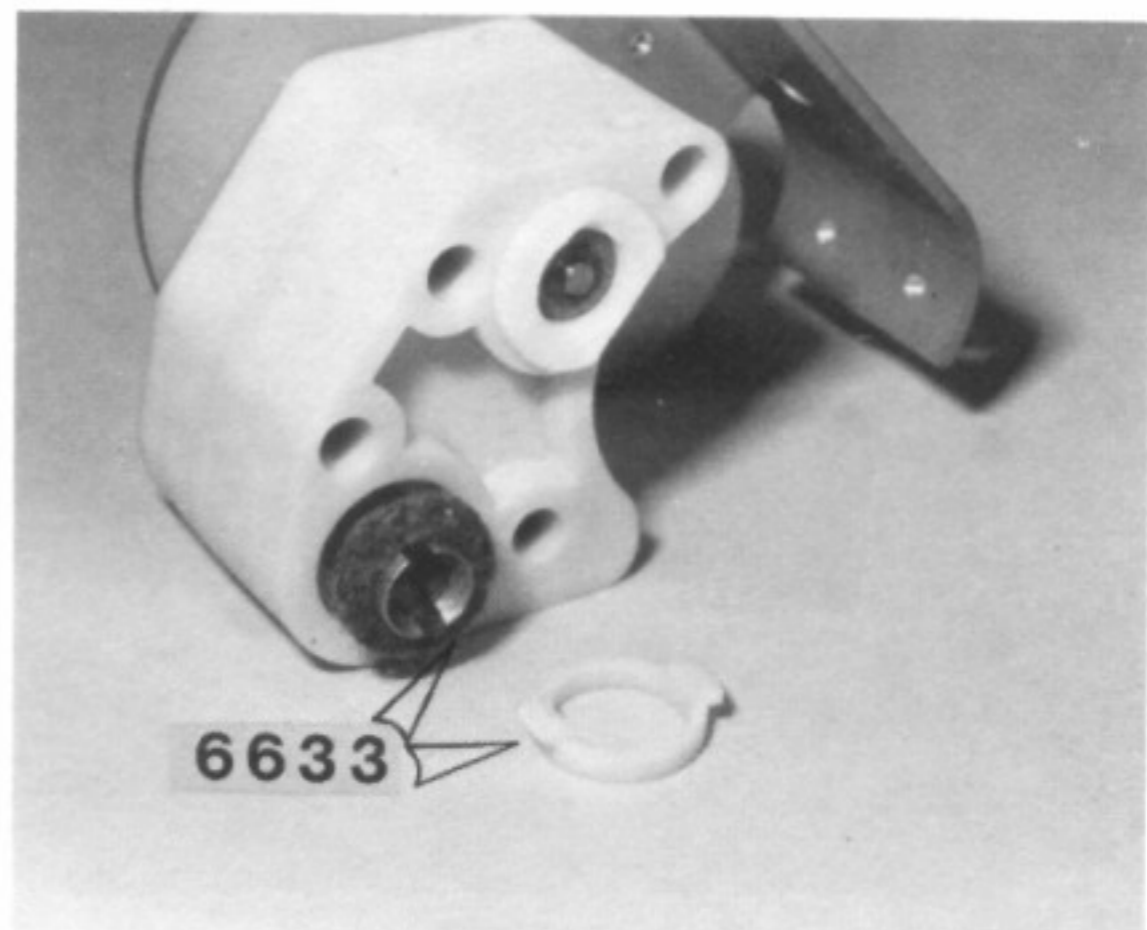

Fig. 95

□ **Fig. 96** Now push the 2 felt retainers on. They should snap in. "Ears" should be horizontal. If they're loose, use a drop of contact cement to hold them in.

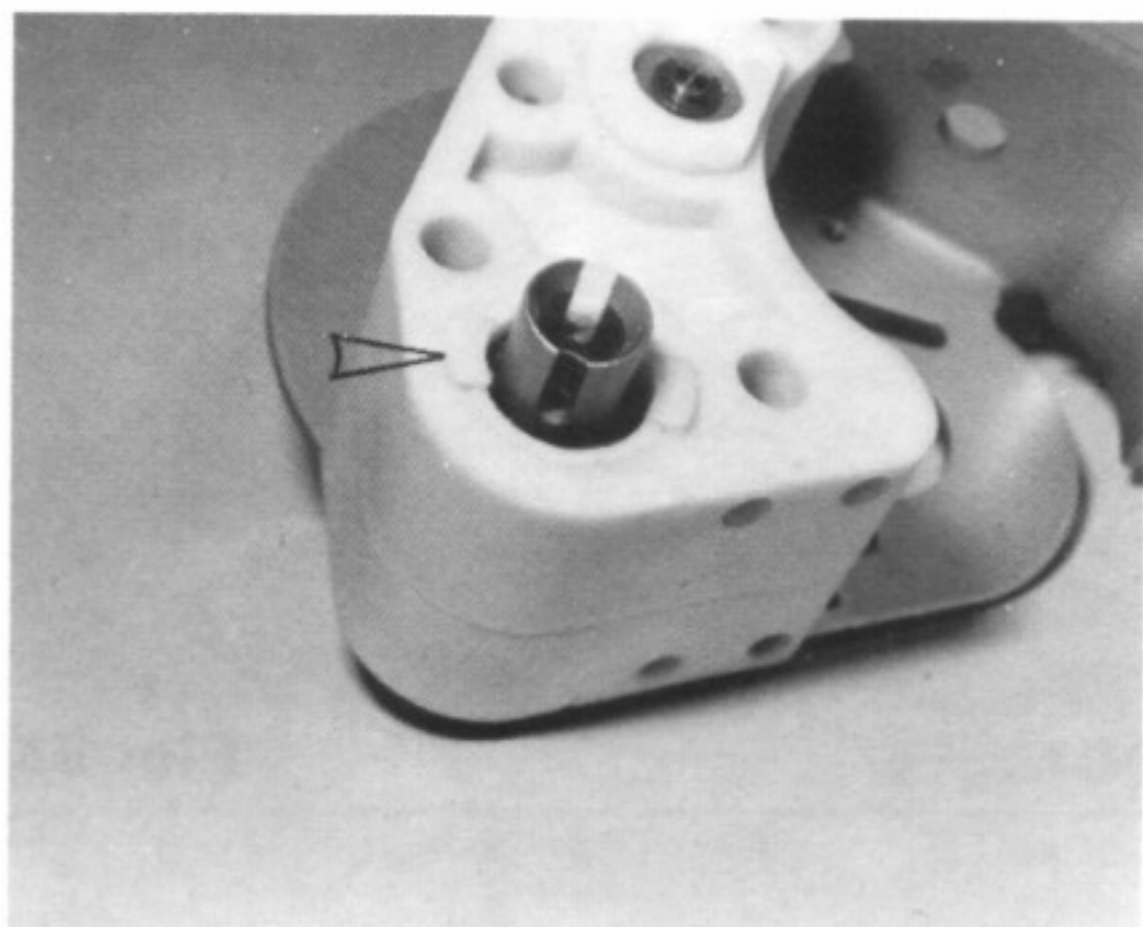

Fig. 96

□ **Fig. 97** Take the sheet of double sided contact tape and cut a piece, as shown.

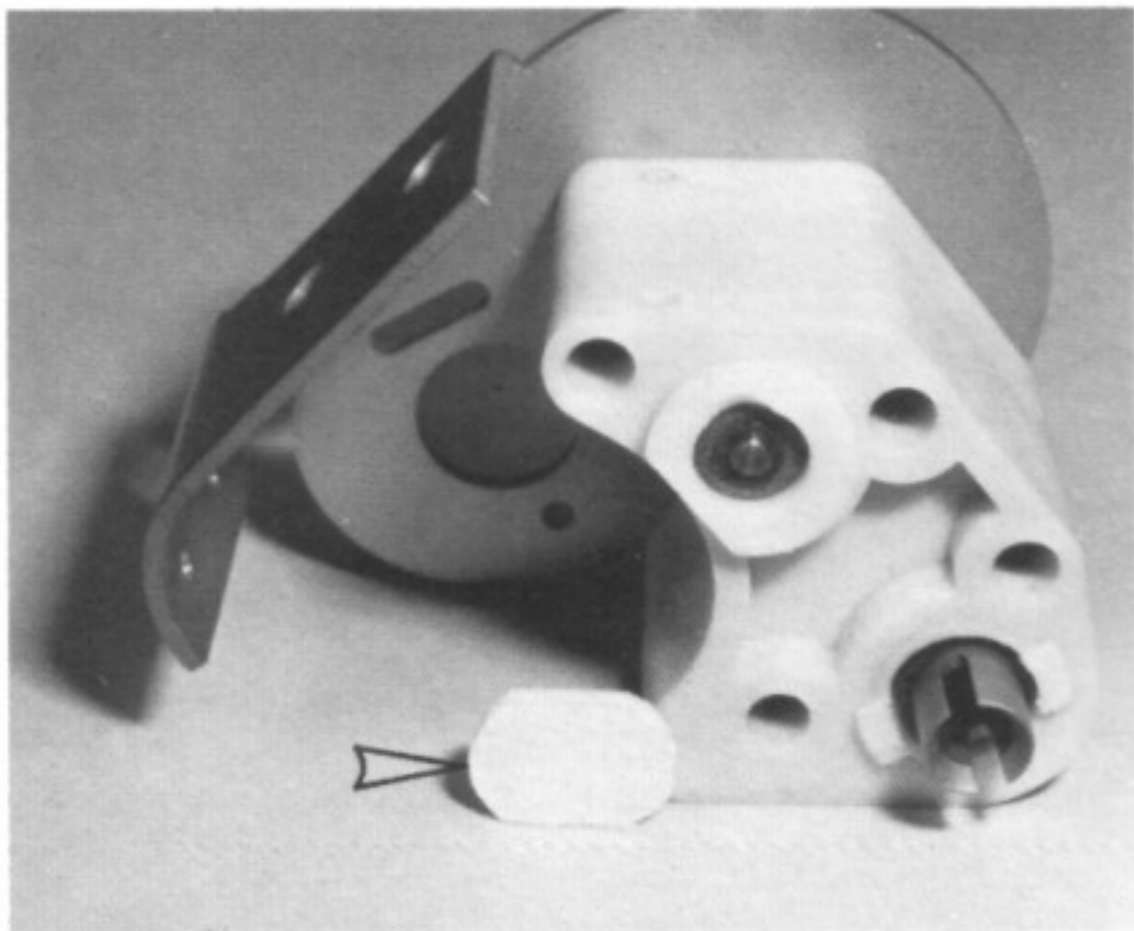

Fig. 97

□ **Fig. 99** From bag #6-4 take the #6323 rear bulkhead out, and the 2 #6327 wing tubes. The wing tubes are the short tubes. Take the tubes, round off the square cut corners on the ends with a file, and tap the wing tubes into the bulkhead.

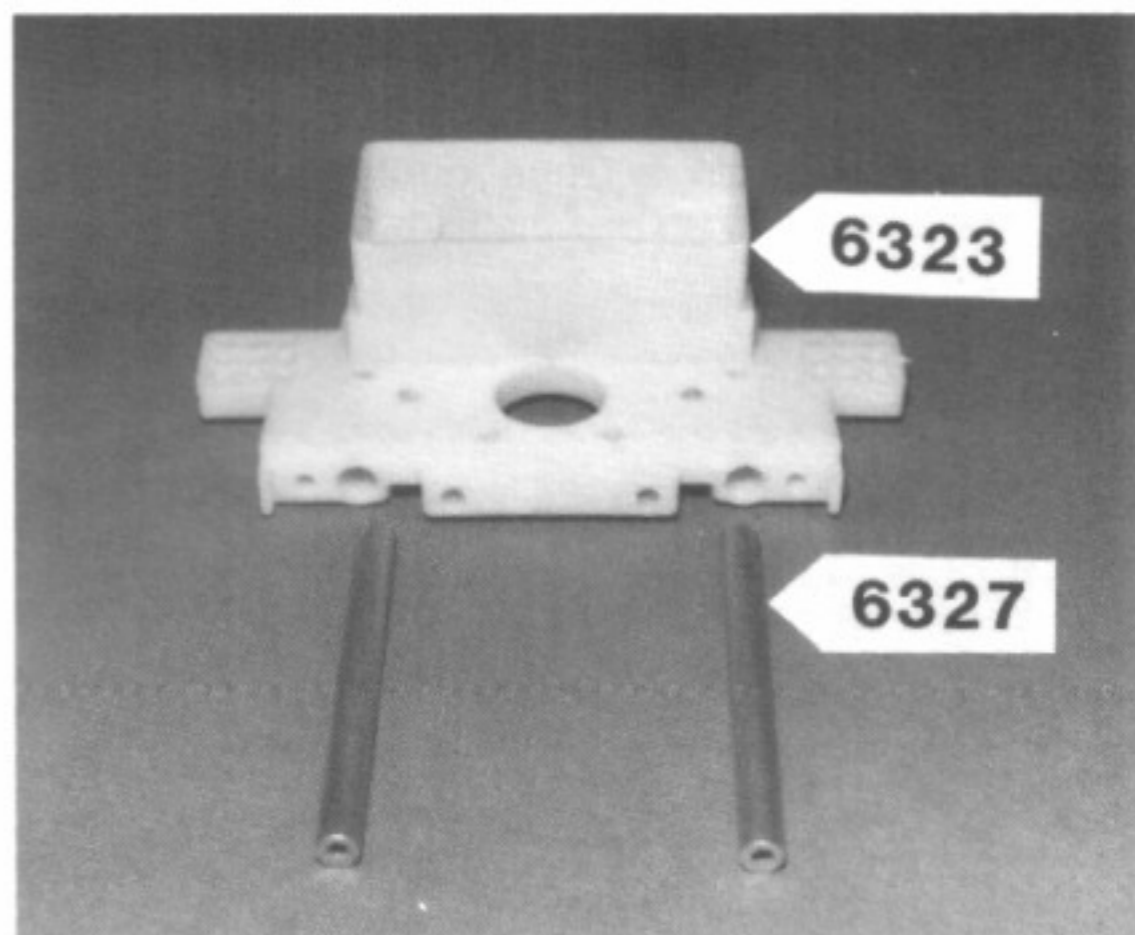

Fig. 99

□ **Fig. 98** Pull the easiest to remove side of the tape off and stick the tape to the housing to act as a dust cover.

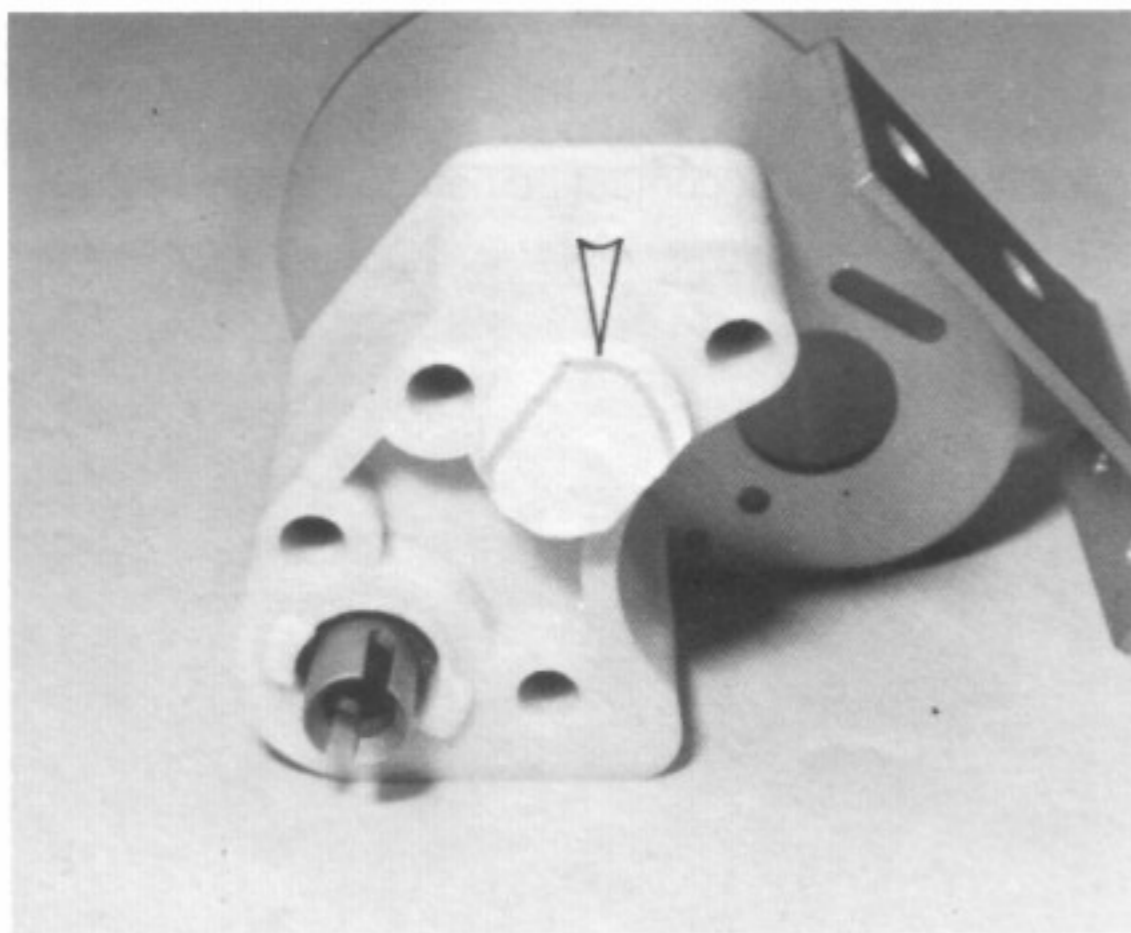

Fig. 98

□ **Fig. 100** Take the 2 Phillips screws and attach the bulkhead to the chassis, but DO NOT tighten the screws all the way down yet, but almost tight. Then install the 2 4/40 Allen screws, as shown, but do not tighten these down yet. We'll be tightening these 4 screws down later.

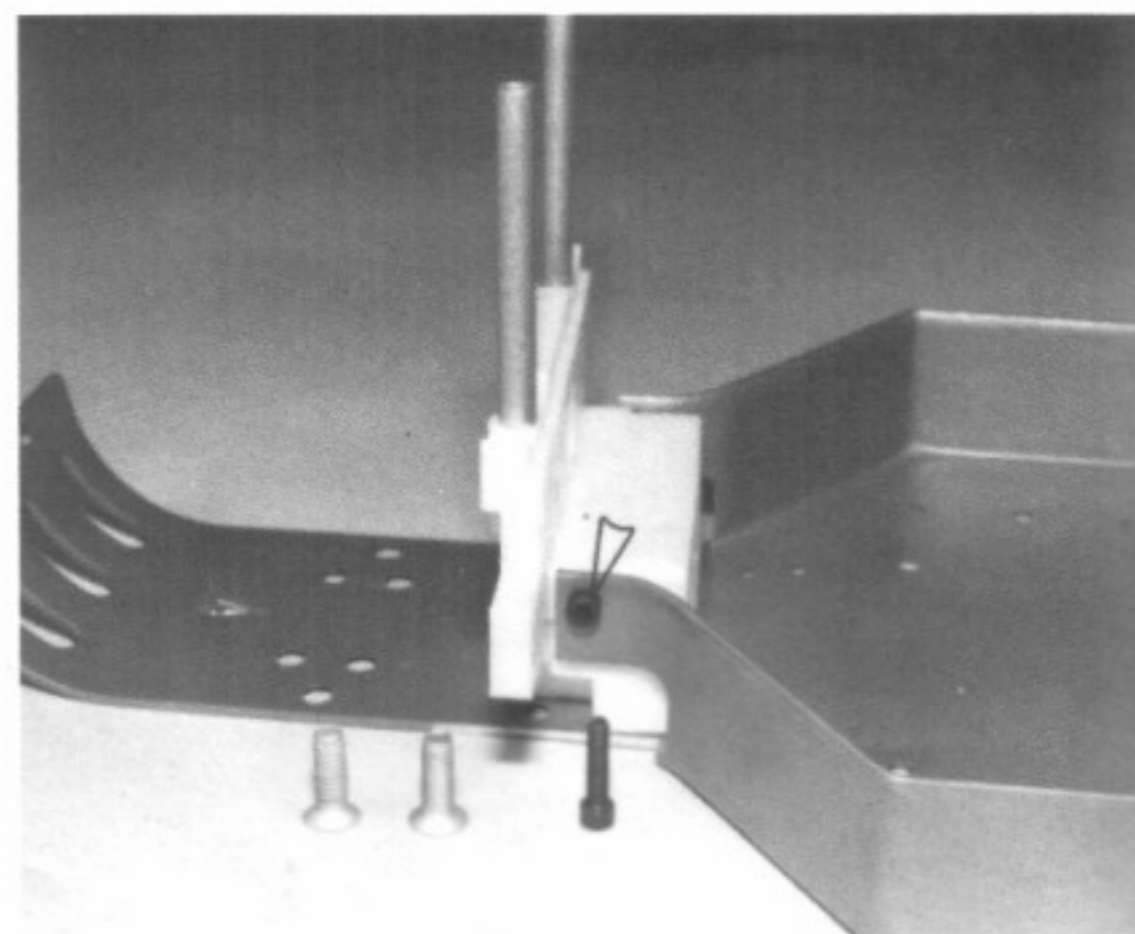

Fig. 100

Fig. 101 Install 2 ball ends into the upper, inner holes, as shown.

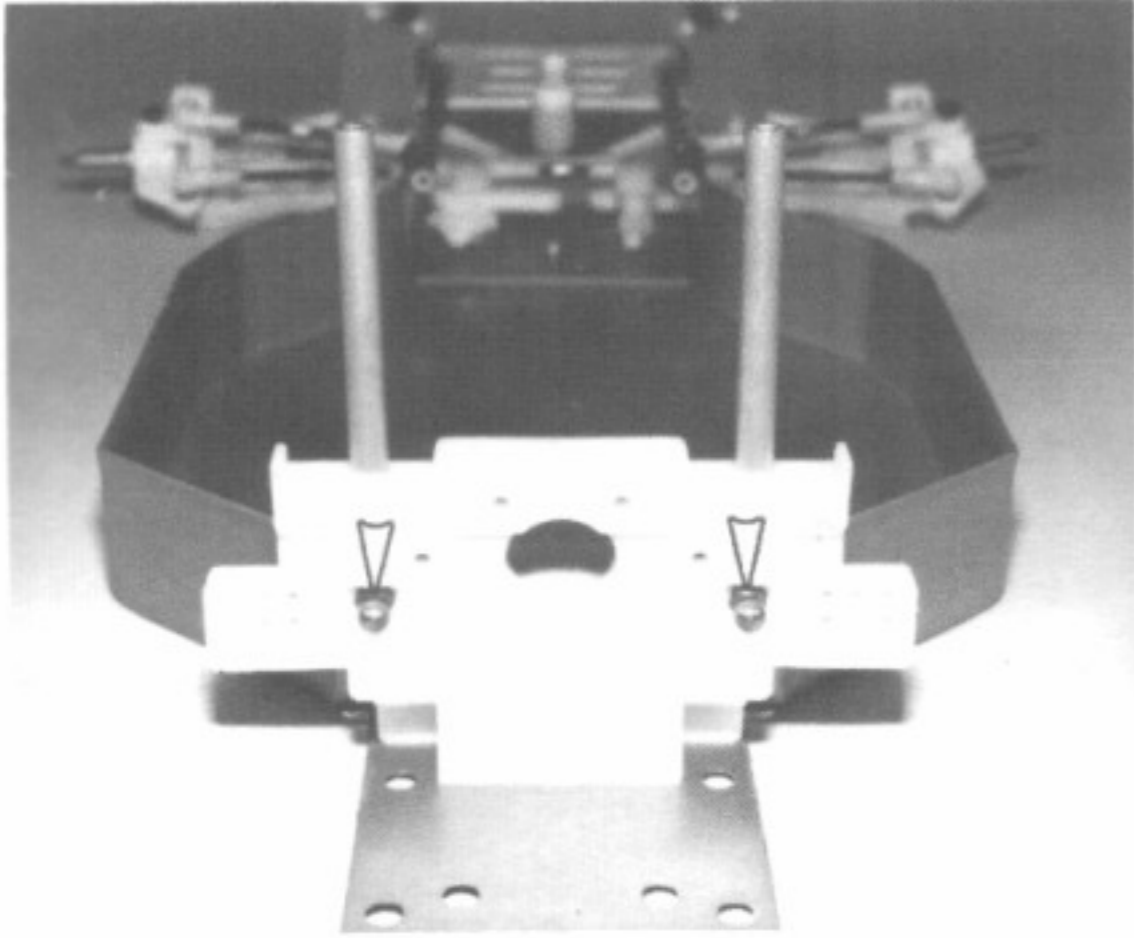

Fig. 101

Fig. 103 These 6 screws should be loose yet.

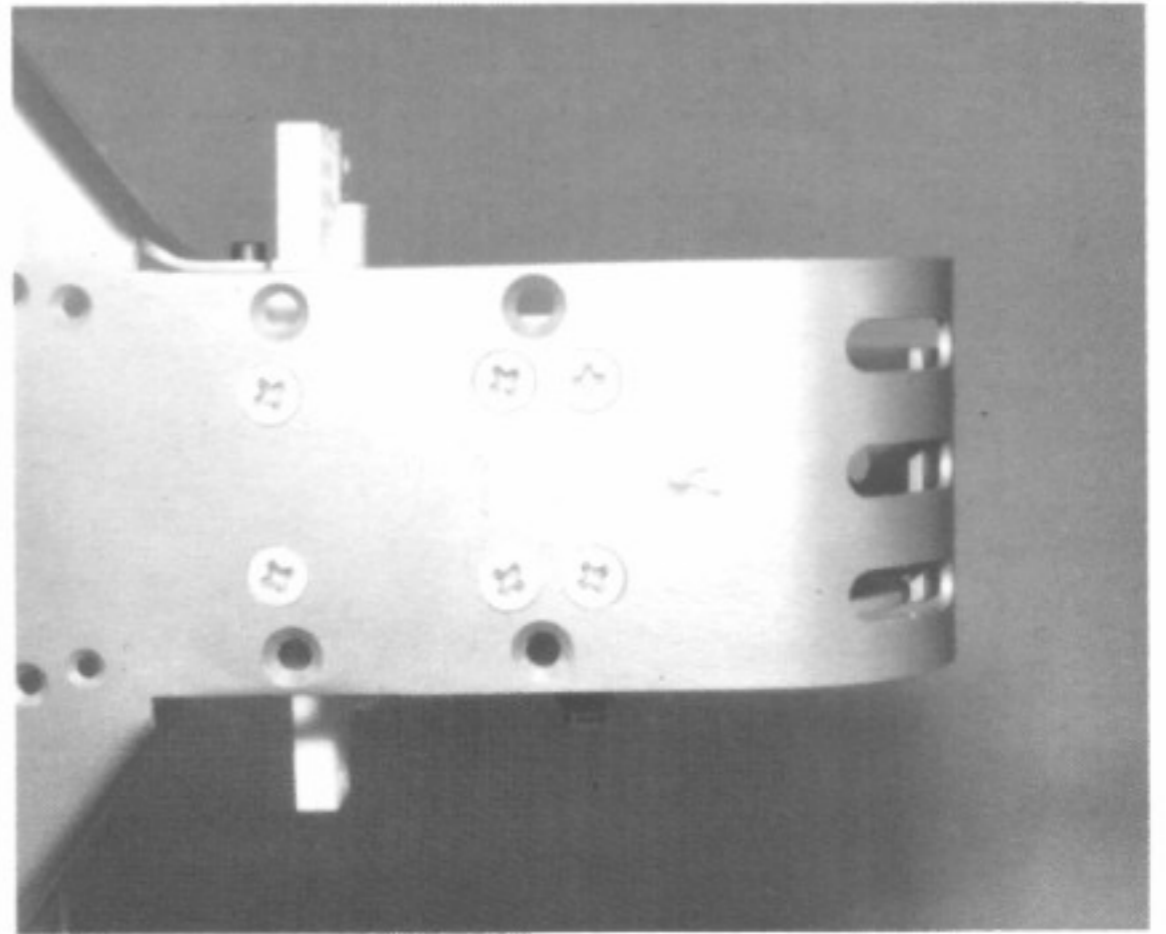

Fig. 103

Fig. 102 Take the transmission housing and install it with 4 Phillips screws. Do not tighten the screws all the way yet. Be sure the motor mount plate is INSIDE of the chassis at the back, as shown.

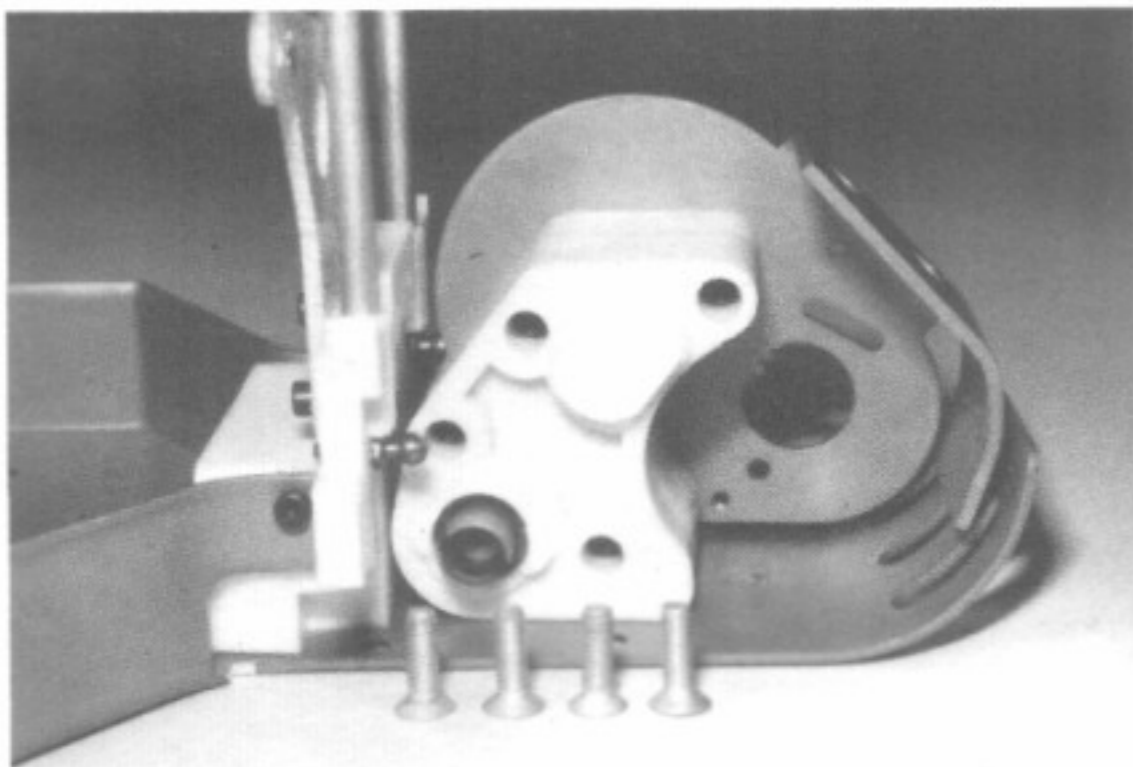

Fig. 102

Fig. 104 Take the #6325 transmission brace and install the rear body mount.

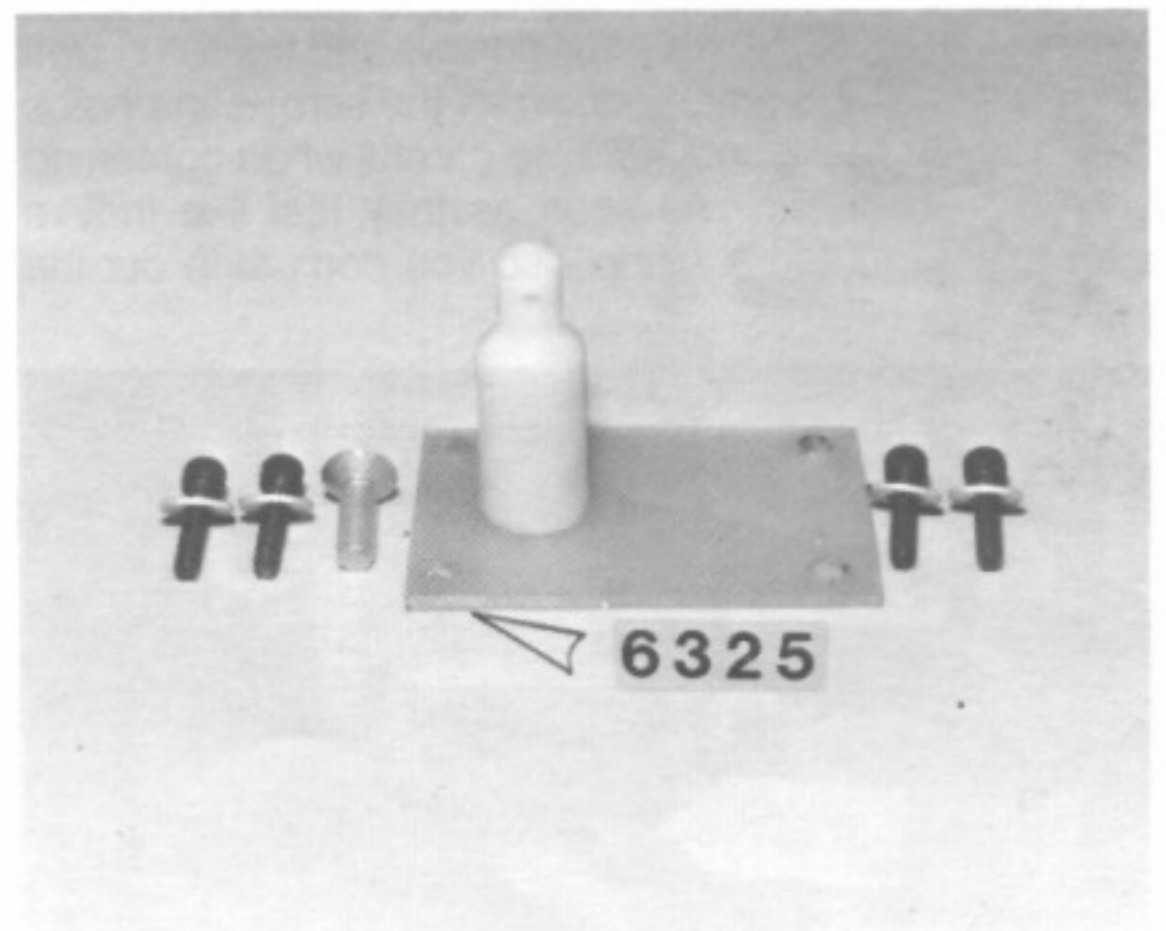

Fig. 104

□ **Fig. 105** Install the transmission brace with 4 Allen screws and washers, as shown, but do not tighten all the way down yet.

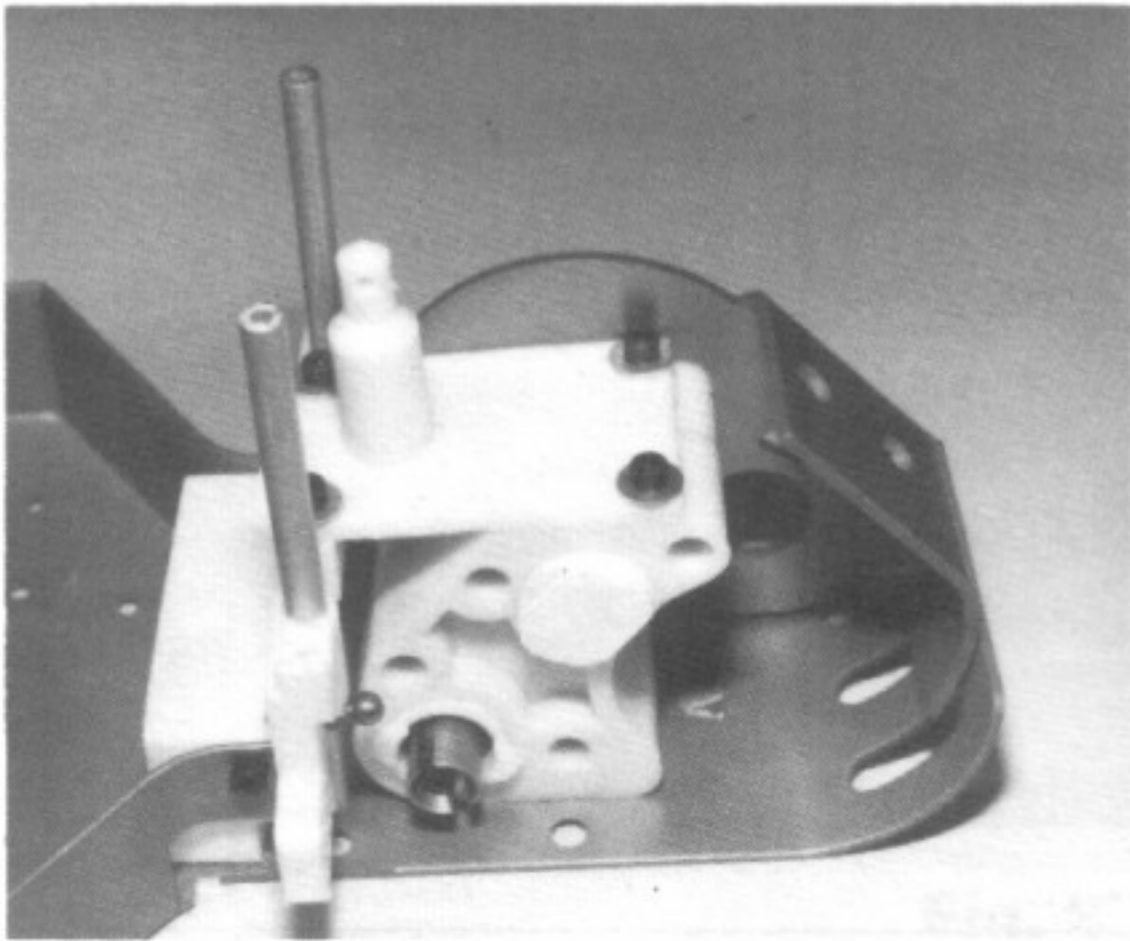

Fig. 105

□ **Fig. 107** Take the #6360 rear suspension mount, out of bag #6-8, with the letter "L" on the bottom, the #6355 L.H. rear "A" arm and the #6380 inner hinge pin. Line up the holes in the arm and mount and install the pin. Install the 2 "E" clips.

NOTE: The left and right rear mounts are attached together by a thin "runner" that should be removed with scissors.

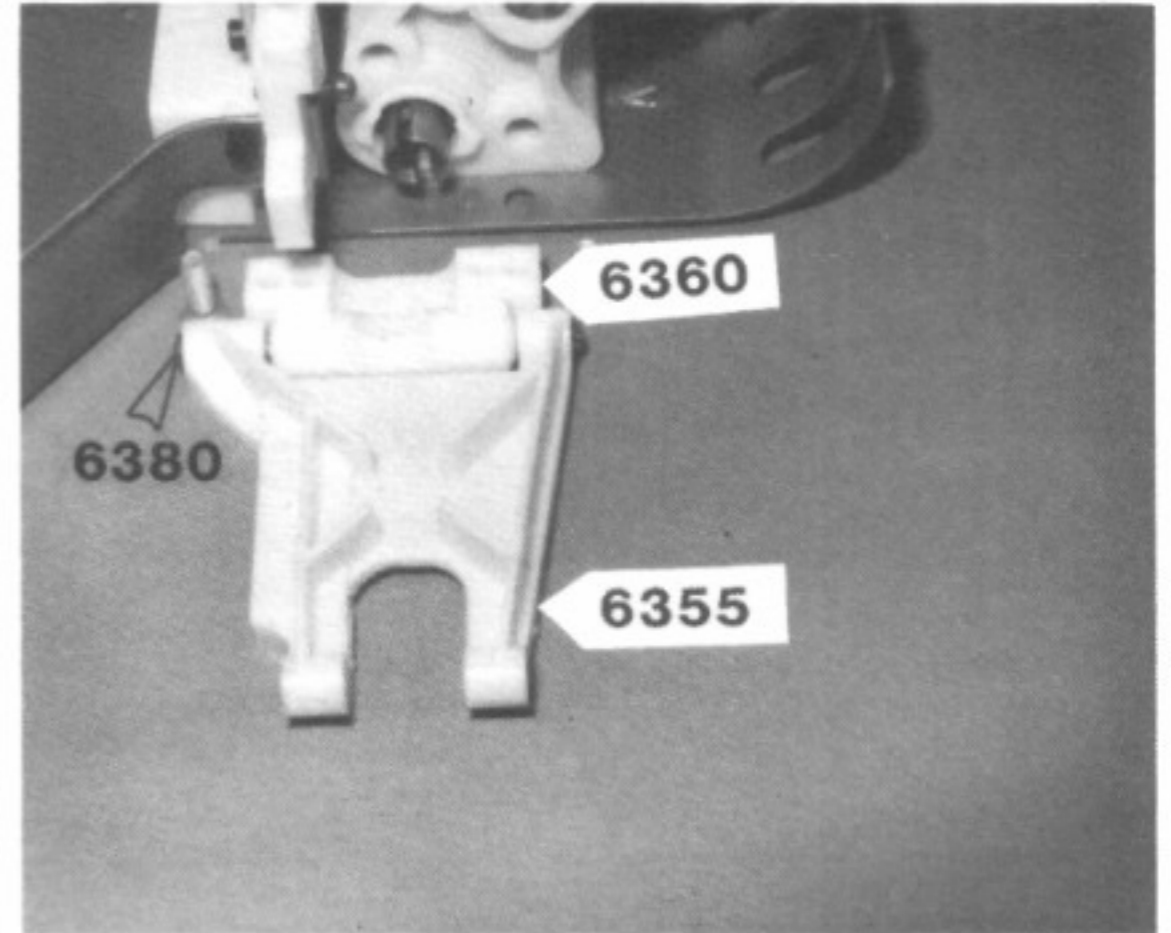

Fig. 107

□ **Fig. 106** Attach the rear of the chassis plate to the motor mount with 2 short Allen screws and tighten down. Now go back and tighten down all the screws in photos #99, 100, 102, 103 and 105. Be careful when tightening screws into plastic. As soon as they feel like they're starting to tighten up - stop - so you don't strip out the plastic.

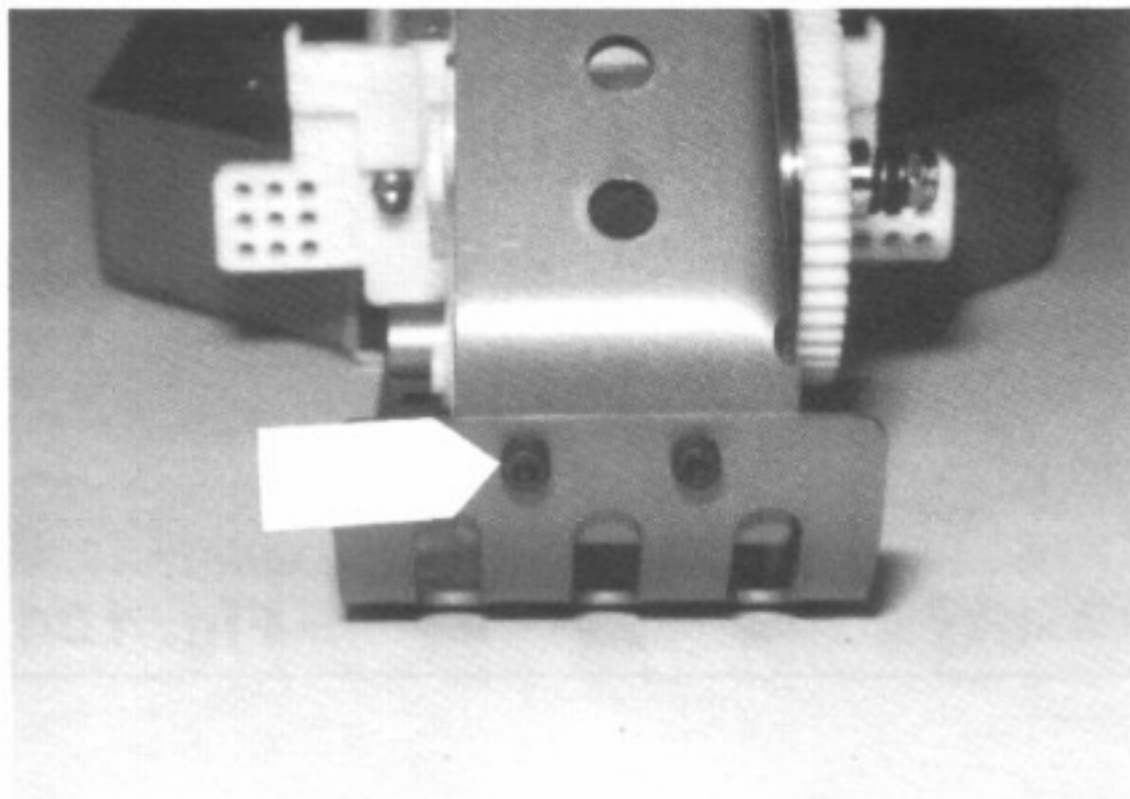

Fig. 106

□ **Fig. 108** Install the L.H. mount to the chassis with 2 Phillips screws as shown. Now, install the R.H. arm.

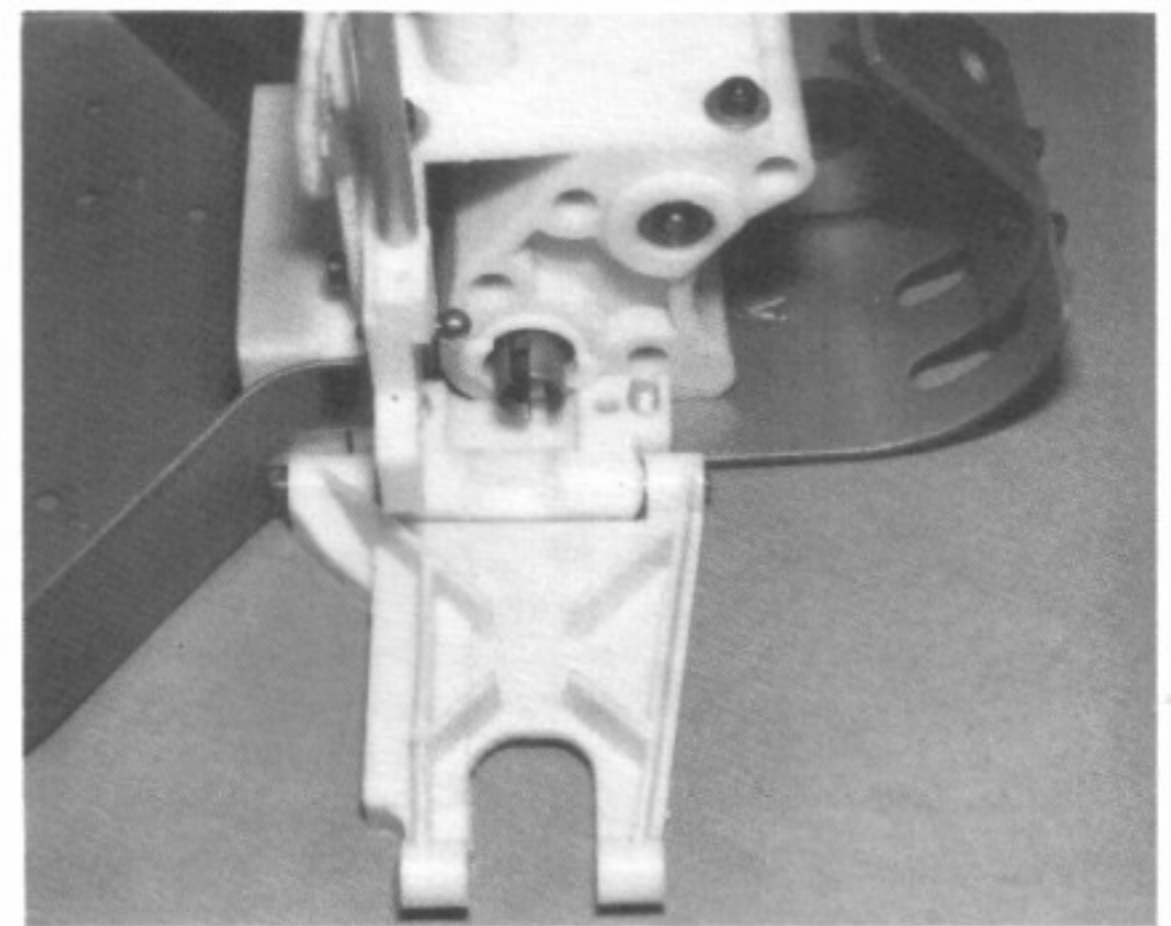

Fig. 108

□ **Fig. 109** Before proceeding with the assembly of the rear hub carrier it's a good idea to check fit of the dogbone in the stub axle. If it does not slide and swivel freely then check for burrs around the dogbone pins or heat treating residue inside the stub axle. Also check that the spring fits freely in the small hole at the bottom of the dogbone socket (see Fig. 115). If either of these holes are clogged they can be cleaned by soaking the stub axle in hot or boiling water for a half hour. Dry and oil the stub axle after cleaning.

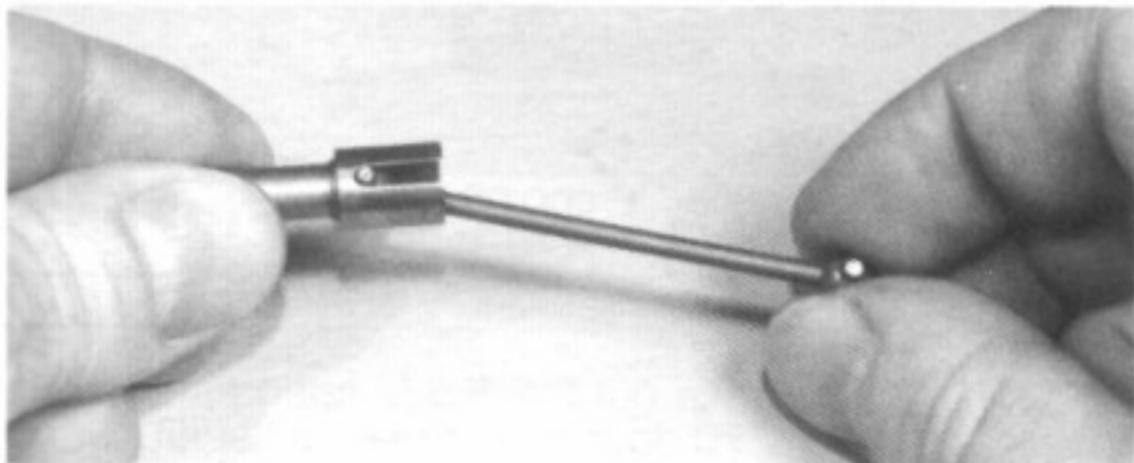

Fig. 109

□ **Fig. 110** Take the #6374 rear stub axle and slip the flat washer, as shown, onto the axle. Install the bushing into the #6366 LH rear hub carrier in the direction shown. If you're installing ball bearings, install one of the large #897 bearings on each side of the #6366 LH hub carrier, and remove the flat washer from the axle. It is only used with bushings. Oil the bushing and slip the axle into the bushing. Now take the cone washer, the one that is not flat, and slip it on the shaft so that the part that touches the bearing is the center of the washer.

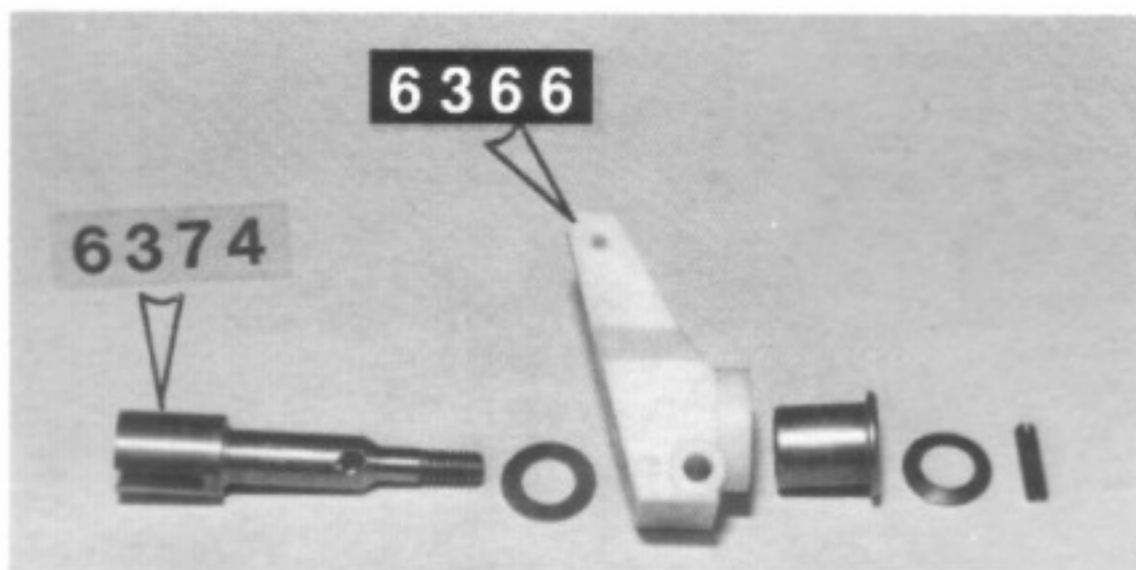

Fig. 110

□ **Fig. 111** For this step you may need 3 hands, so get a friend to help you. Set the axle on a vise or a flat surface. Hold the roll pin or slotted pin with a needle nose pliers and align the pin with the hole in the axle. Lightly tap the pin in the axle so it's evenly spaced.

An alternate method of installing the pin is shown in Fig. 111a, using a pair of water pump pliers. Start the pin by holding with small pliers and pushing into the hole with a twisting motion. Finish with large pliers as shown. Angle the pliers slightly to allow the pin to come through the other side.

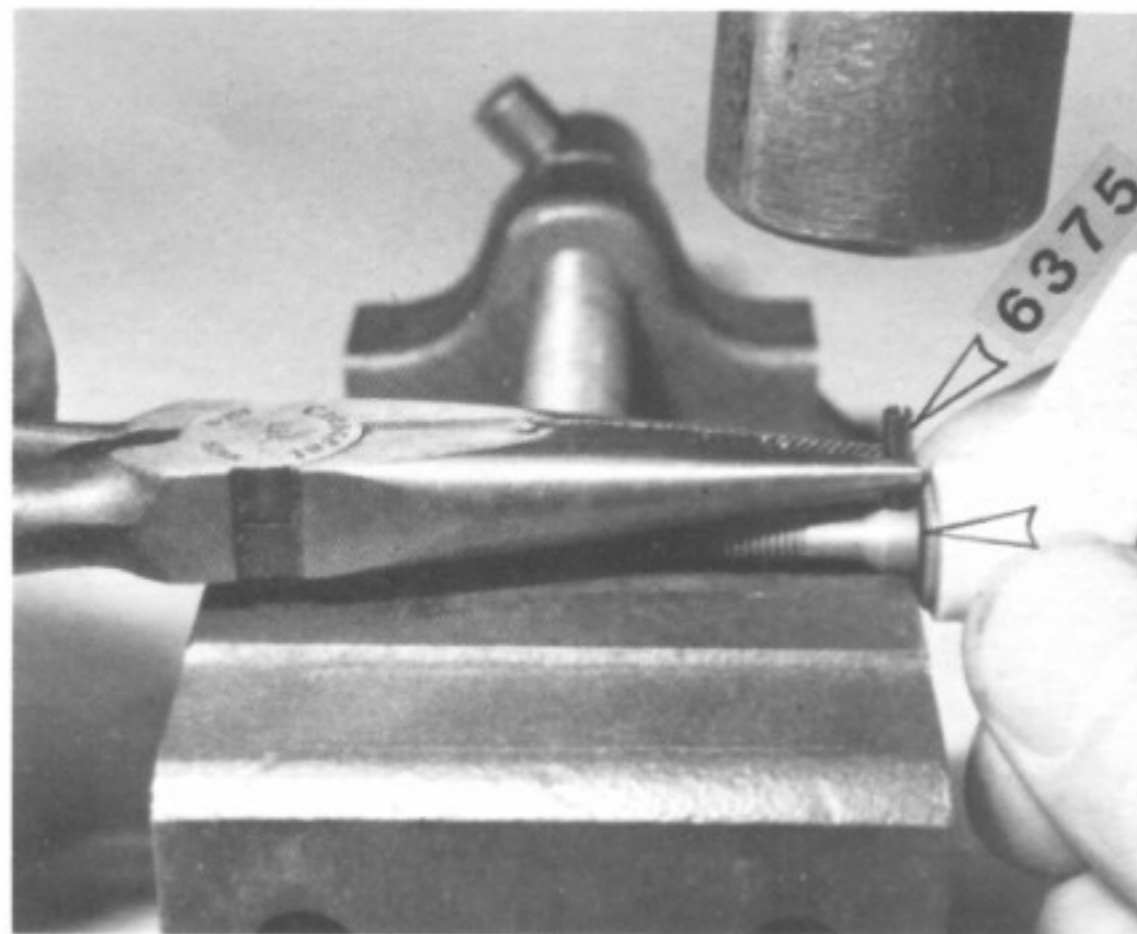

Fig. 111



Fig. 111a

□ **Fig. 112** Install the LH hub carrier in the LH "A" arm with the #6381 outer hinge pin. Install 2 "E" clips. Install a long ball end in the forward side of the hub carrier, as shown, and install the nut. Install the R.H. hub carrier.

NOTE: The pin is intentionally a tight fit in the hub carrier; do not ream the hole. The pin will turn in the A-arm.

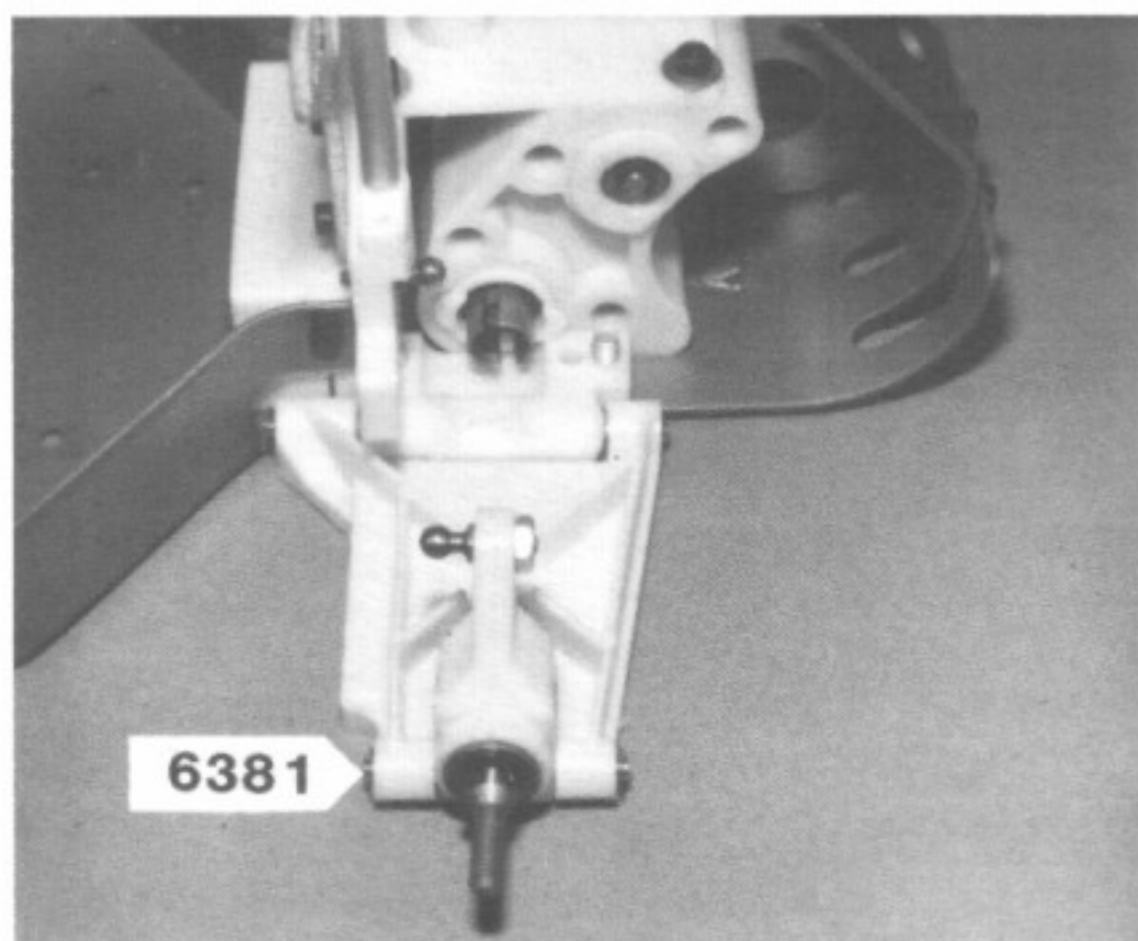

Fig. 112

□ **Fig. 113** Your L.H. rear end should look like this now.

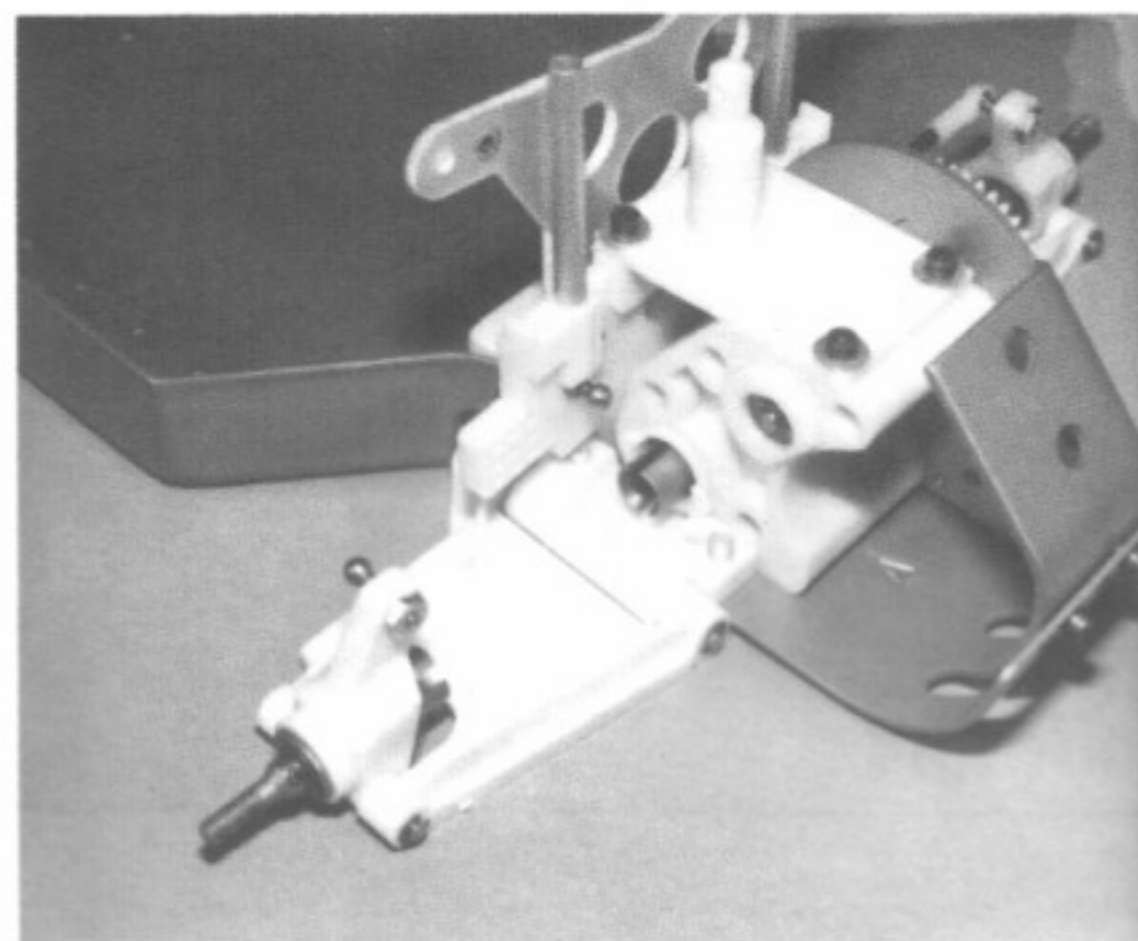

Fig. 113

□ **Fig. 114** Take the 2 threaded rods and screw 2 plastic rod ends on each to the dimension shown. Note that on this strut one ball faces forward and one faces to the rear.

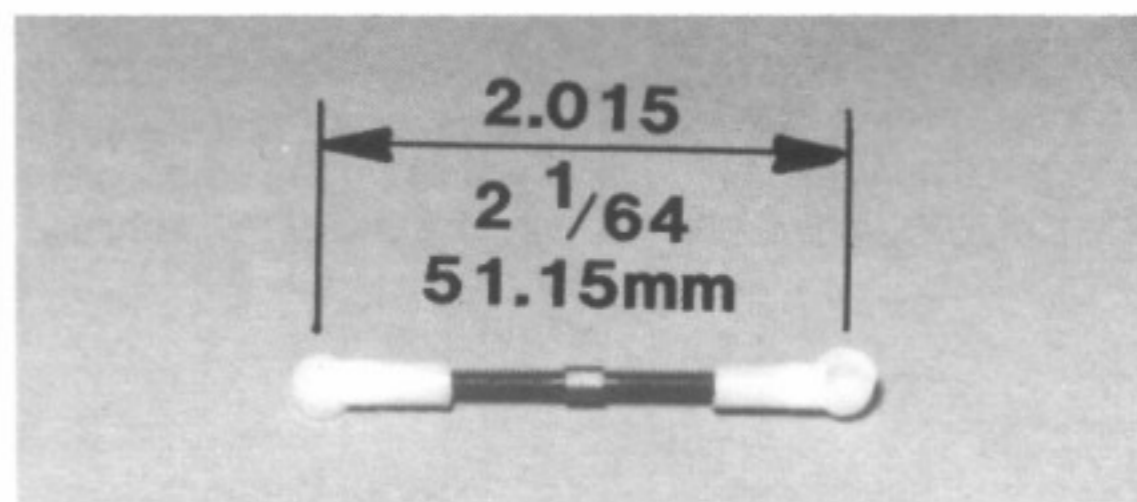

Fig. 114

□ **Fig. 115** Take out the #6372 spring and nylon washer and the #6370 dogbone or rear half-shaft. Push the nylon washer into the #6612 axle drive gear.

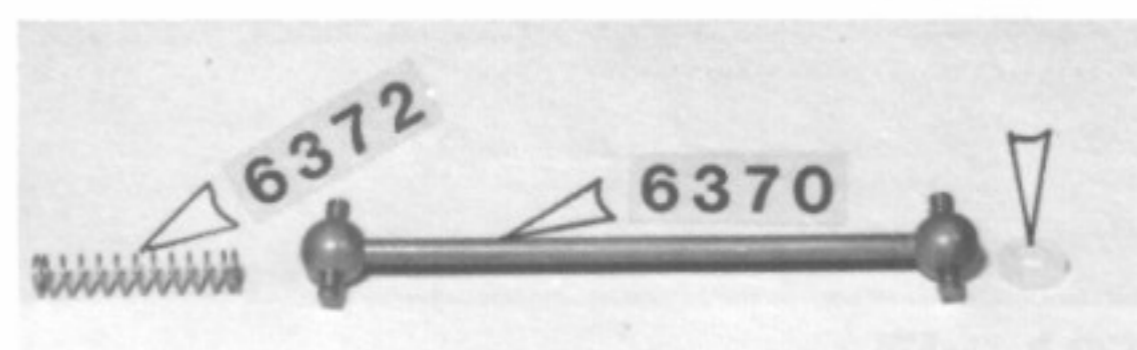

Fig. 115

□ **Fig. 116** Put the strut (A) onto the ball on the bulkhead. Put the spring inside the stub axle, and make sure the spring fits freely in the hole. If the spring binds you may be able to clear the hole with an Allen wrench; or you can reread step 111. Put the dogbone or half-shaft into the gear slot. Now, align the stub axle with the dogbone and slide it in. Put the strut (B) on the ball in the hub carrier. It should look like Fig. 116 now. Do the R.H. side.

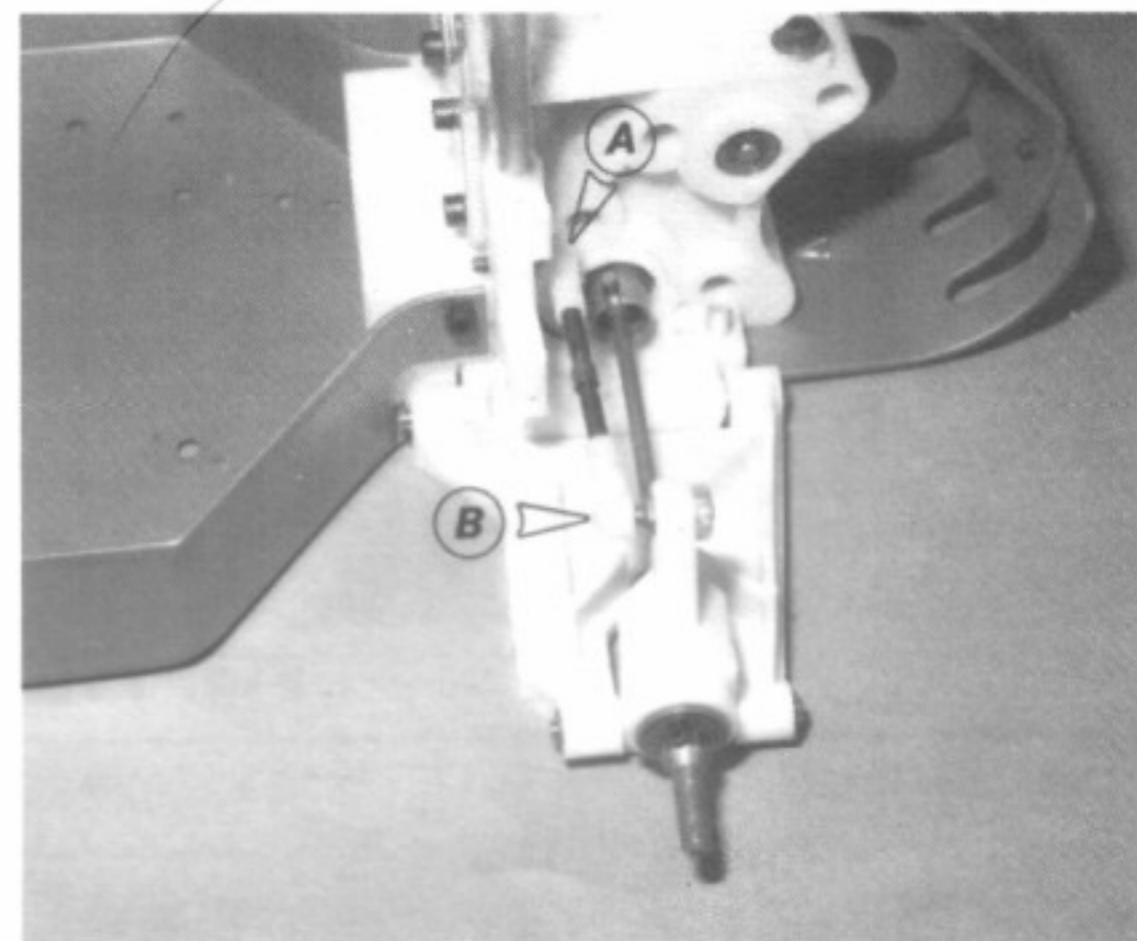

Fig. 116

□ **Fig. 117** Take bag #6-9 and we'll assemble the rear shocks now. Take out the parts, as shown.

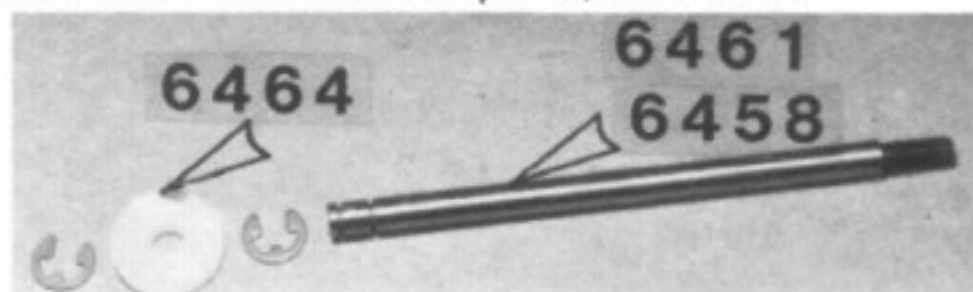

Fig. 117

□ **Fig. 118** Slip on one "E" clip.

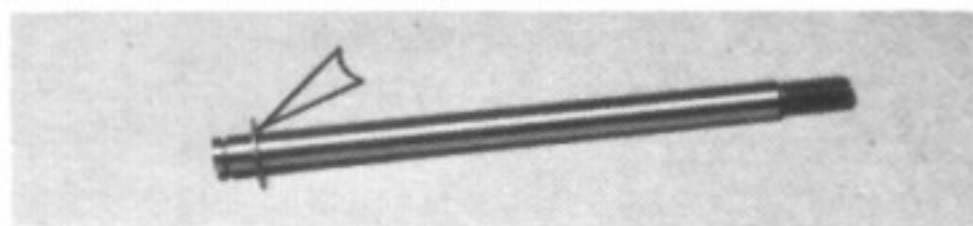

Fig. 118

□ **Fig. 119** Slip on the #6464 piston and then another "E" clip. Make sure the "E" clips are fully seated. Take 3 of the plastic spacers, as shown, and slip them onto the shaft from the threaded end. Push the spacers all the way up to the piston. This will add a "downstop" to your rear shocks which will prevent the wheels from dropping down too far and possibly breaking a dogbone. Add the stop to the REAR SHOCKS ONLY.

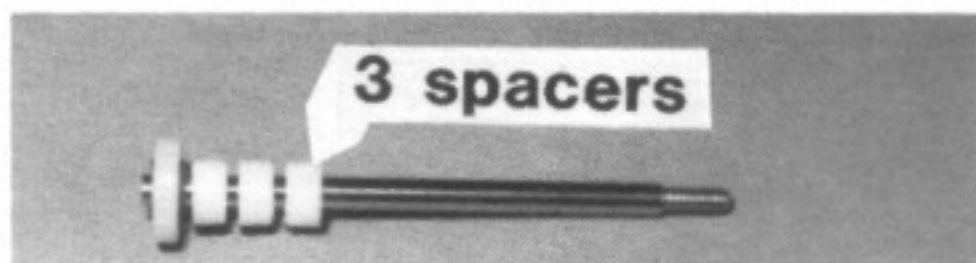

Fig. 119

□ **Fig. 120** Take the #6452 and install the parts in the end in the order shown (see also Fig. 120a). First, push the small nylon washer in all the way to the stop. Next push in one red "O" ring. Then the nylon spacer, and now the 2nd red "O" ring. Then the large nylon washer. Now install the large inner "C" clip. Start one end of the clip in, hold it down with your finger. Now, with a small screwdriver, push the other end over and in. If you have trouble installing the clip try this other method: start one end of the clip in and hold it down with your left thumbnail. Now start working your right thumbnail around, pressing the ring into the hole as you go. By the time you get to the other end of the clip it will snap into the groove.

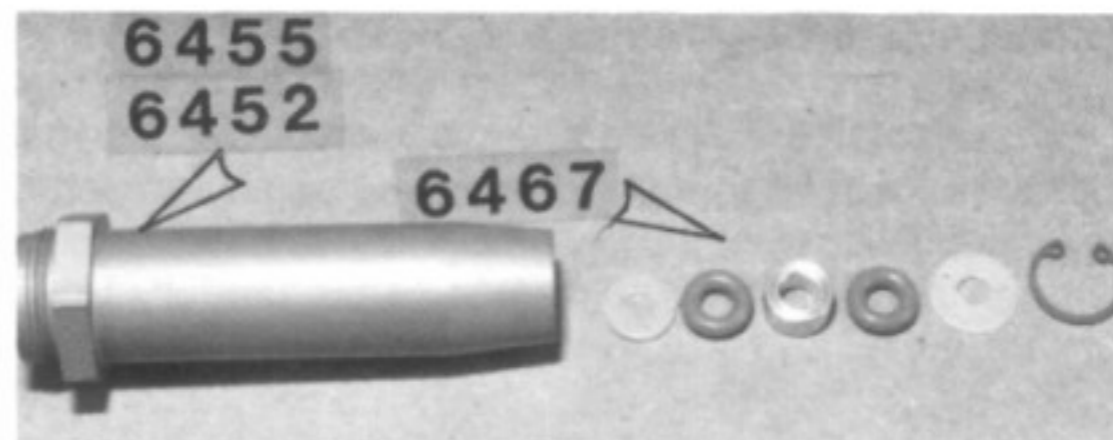

Fig. 120

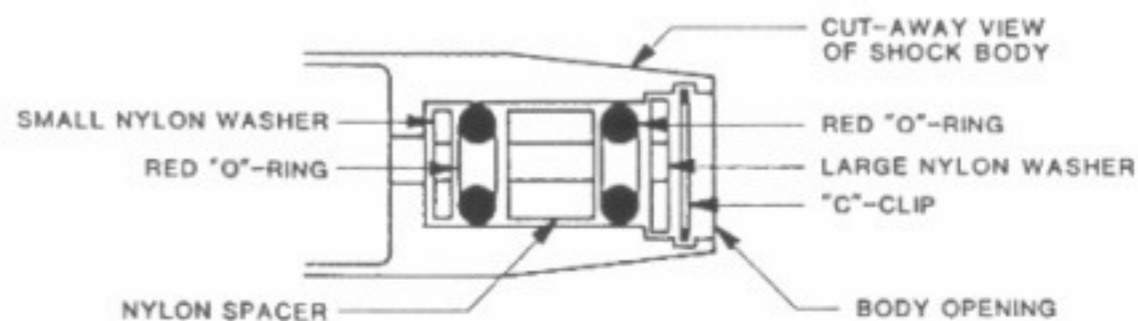

Fig. 120a

□ **Fig. 121** Make sure the clip is fully seated.



Fig. 121

□ **Fig. 122** Your kit comes with the highest grade synthetic shock oil available. However, Associated also has available a better racing silicone shock oil (Fig. 122) used by the Team. If you're planning on using the silicone oil, it's better to use the silicone oil first instead of using the synthetic oil.



Fig. 122

Fig. 122a While holding the shock body upright as shown, block off the hole at the bottom with your finger and put about 10 drops of oil into the shock body to lubricate the "O" rings. Now, very carefully and smoothly, push the shock shaft down through the shock body and through the "O" rings. You want to do this carefully so you don't cut the "O" rings which will make the shock leak. Release your finger from the bottom and pull the shaft SLOWLY all the way through until the piston bottoms out. While still holding the body upright, fill the body with the shock oil to within 1/32" (.79mm) of the top. Note - on the front shocks, which are shorter, you can fill the oil all the way to the top of the body.

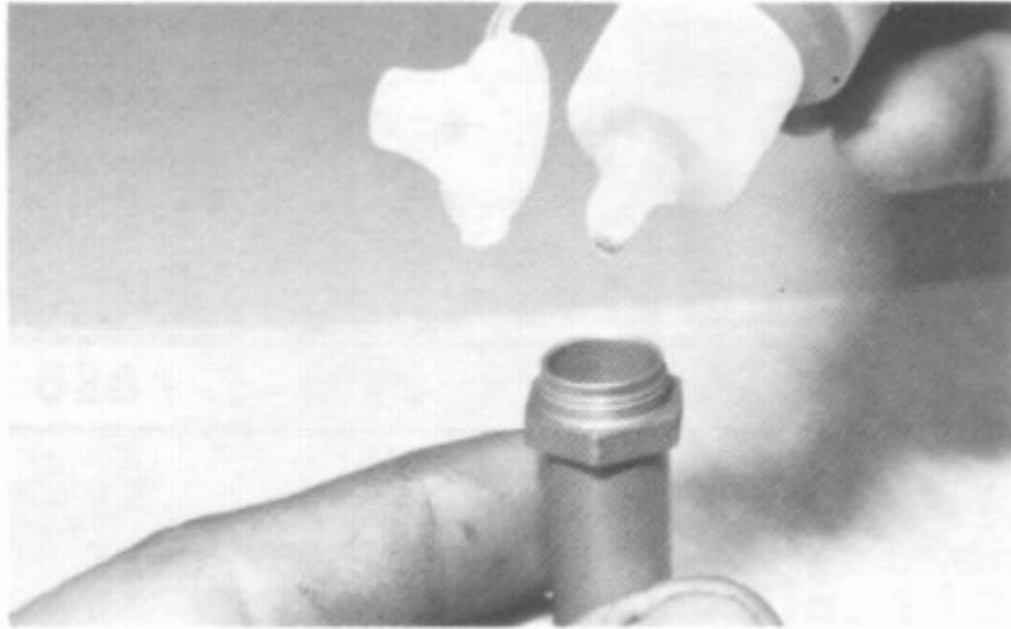

Fig. 122a

Fig. 123 While holding the body upright, slip the large nylon washer down over the threads. Now screw the #6463 cap down over the body.

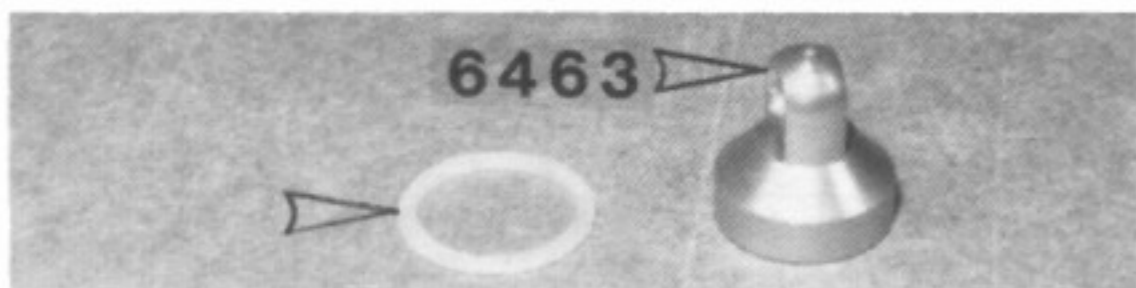

Fig. 123

Fig. 124 You can use a 1/2" wrench, or the Associated #6955 shock wrench to hold the nut, then stick a rod through the cap and tighten it down.

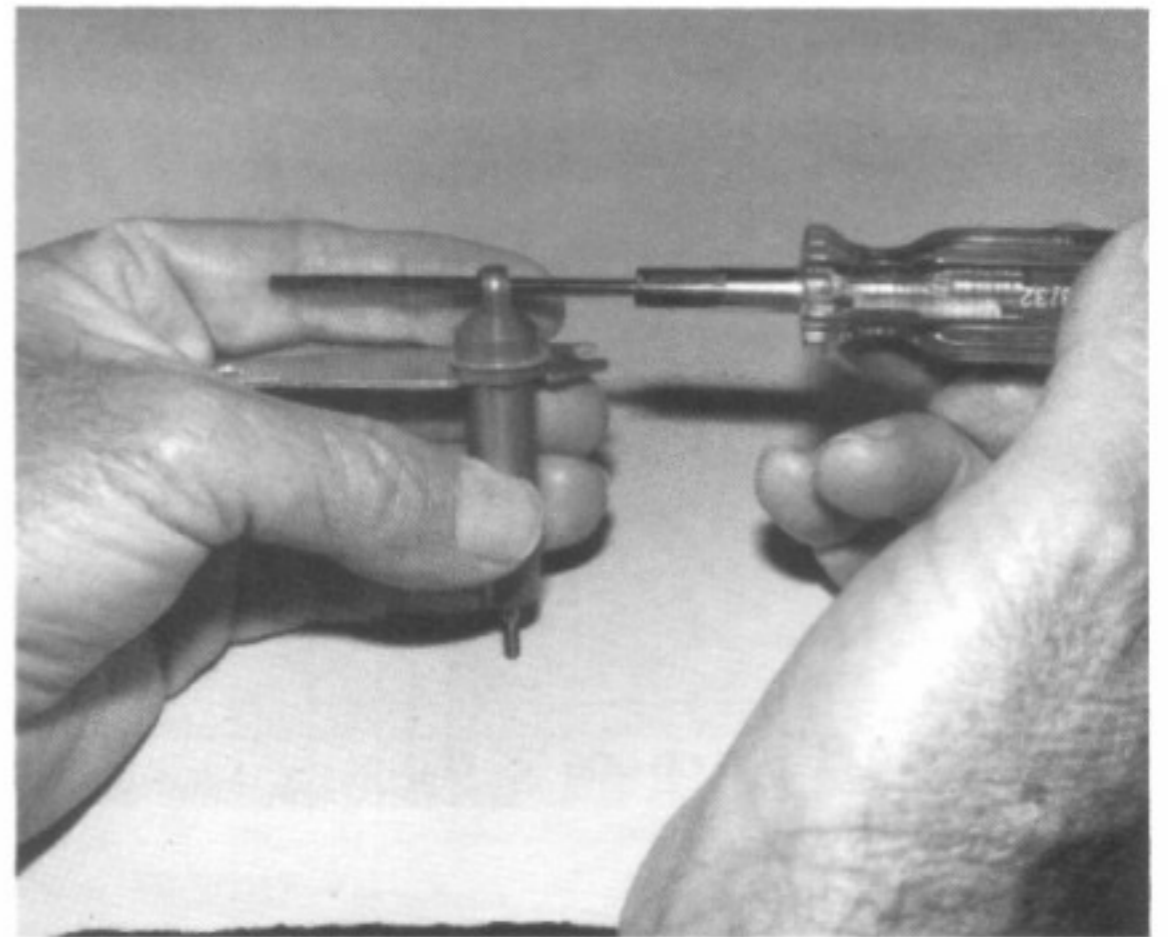

Fig. 124

Fig. 125 Your shock should look like this. Now do the other rear shock and the 2 front shocks in bag #6-10. Remember that the front shocks don't use the plastic stops.



Fig. 125

Fig. 126 Your front and rear shocks should look like this, and they should all feel quite smooth when you move the shafts in and out.

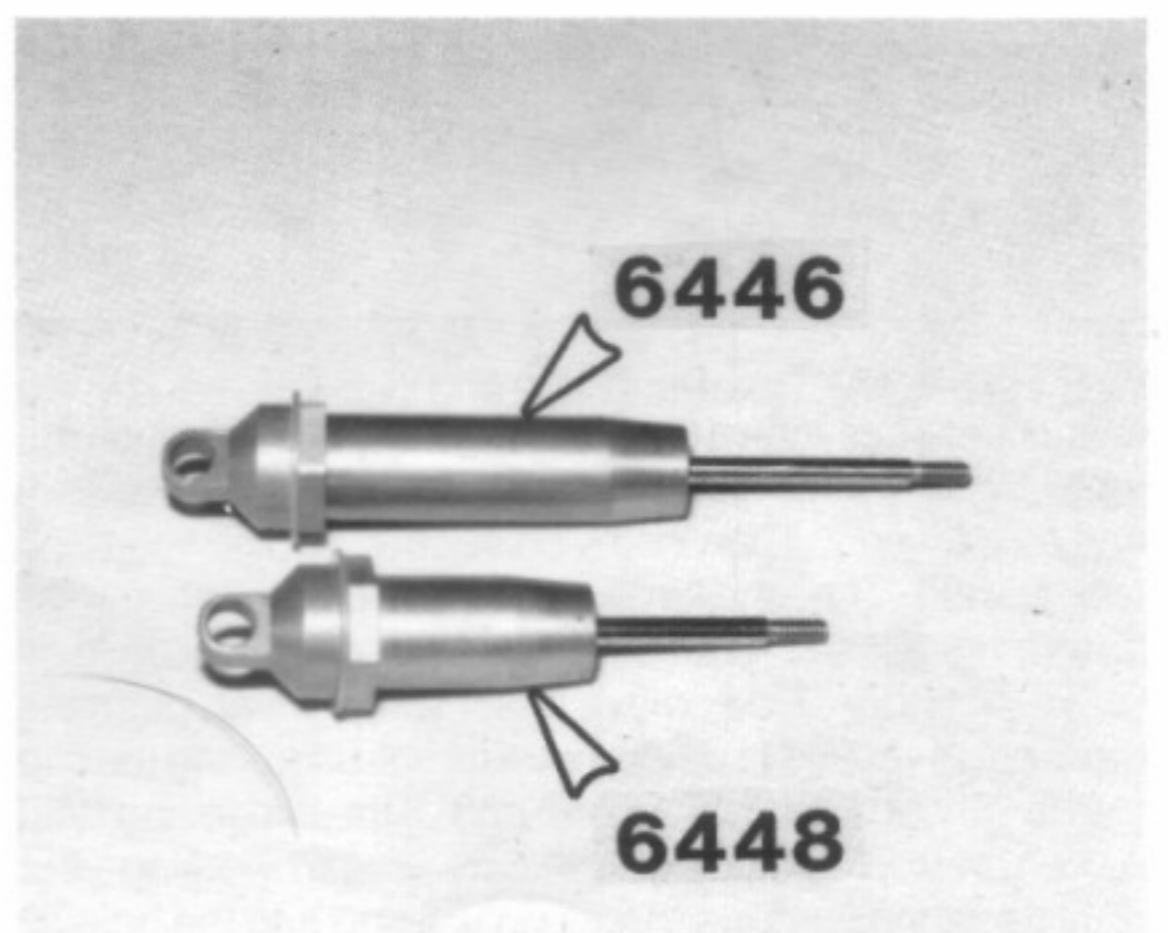

Fig. 126

□ **Fig. 127** From Bag #6-11, install the 2 #6474 spring clamps on the rear shocks. The spring should go over the thin flange. Install one with the screw head up, as shown, and the other with the screw head down. There should be a 1/4" (6.35mm) space between the collar and the body hex nut. Tighten the screws just enough to lock the collars. DO NOT overtighten. Slip on the long silver #6478 spring. There is also a long gold spring, which is stiffer than the silver spring. The silver spring will work best on most tracks, but you can experiment with the gold spring also, on your track. Take the #6471 plastic rod end and push it onto the metal ball. The easiest way to do this, is to lay the metal ball end on a table, with the flat end on the table. Set the plastic end on the ball and push it in place with your 1/4" nutdriver. Slip the spring holder on the shaft and into the spring and collapse or squeeze the spring. Then thread the plastic ball end on the shaft. You'll have to keep the shaft from rotating with a needlenose pliers. Grab the shaft close to the threads so that you don't scratch the part that rides in the "O" rings.

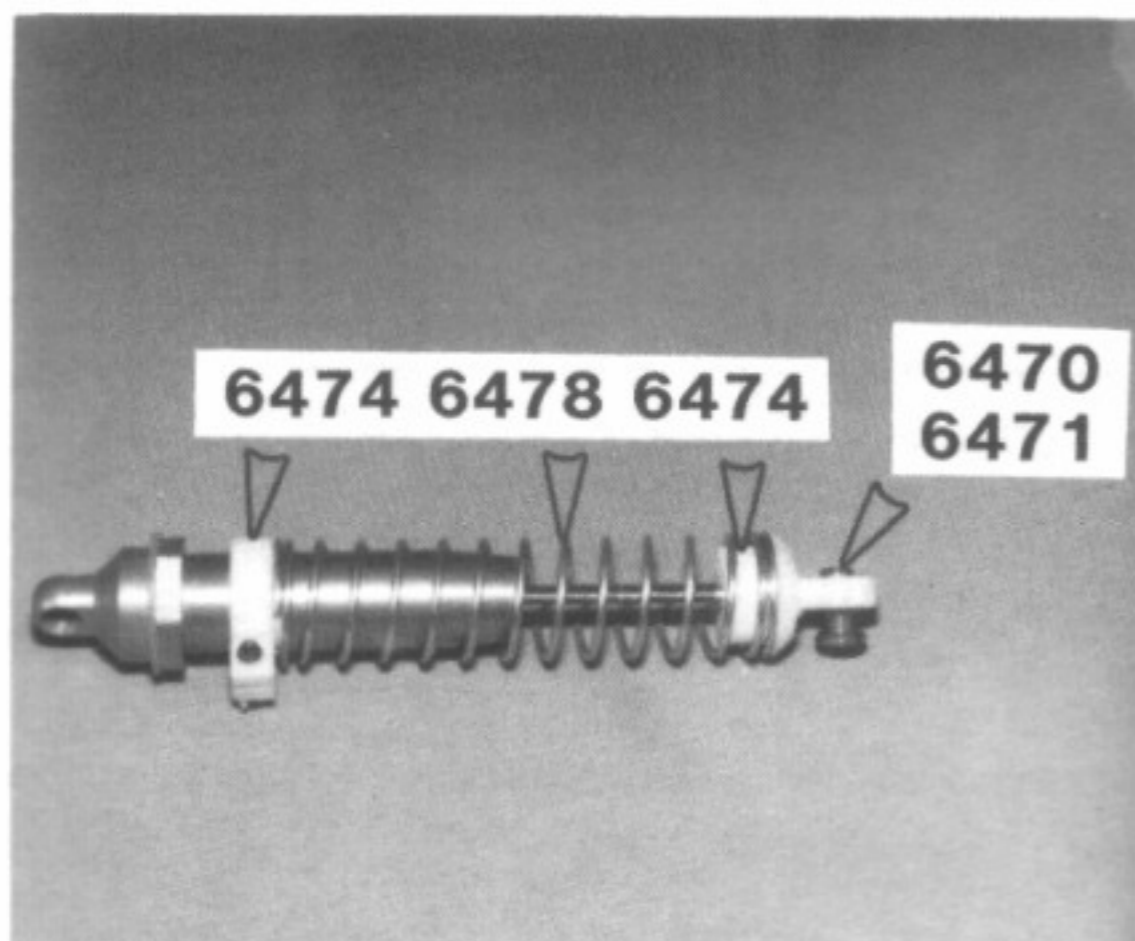

Fig. 127

□ **Fig. 128** On the front shocks, install the spring collars, as shown. Use the short silver spring, which is softer than the short gold spring. Again, you can experiment with both springs, but start with the silver spring. Install the spring cups that go inside the springs, as shown, and then install the plastic ball end. Your shocks are now complete.

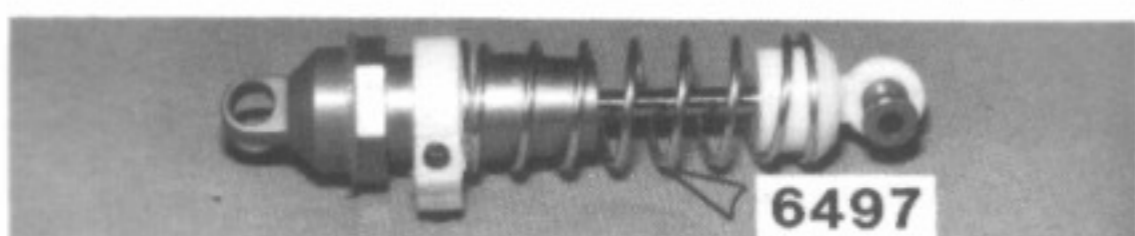

Fig. 128

□ **Fig. 129** Now we'll install the front shocks on the car. The arrow in the photo is pointing to the upper mount. Now slip on an aluminum washer and then screw down and tighten one of the 4/40 plain nuts. The arrow is pointing to the flanged nylon shock bushing. Slip this bushing on next, with the flanged end on first.

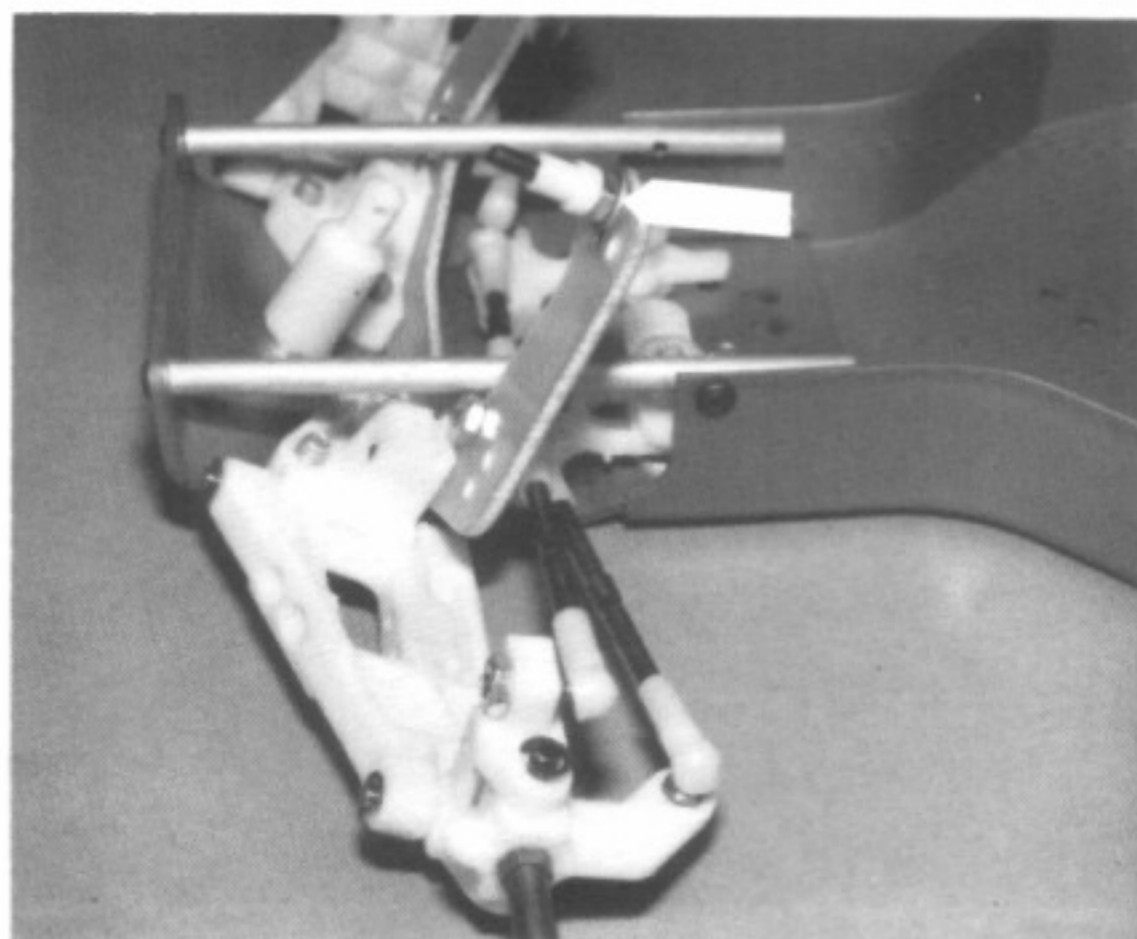

Fig. 129

□ **Fig. 130** Slip the shock on the upper mount and install a locking nut. DO NOT tighten down too tight on this nut or you'll bind up the shock. Squeeze the bottom end of the shock up and then slip the end down into the lower "A" arm slot, with the flat side of the ball to the rear.

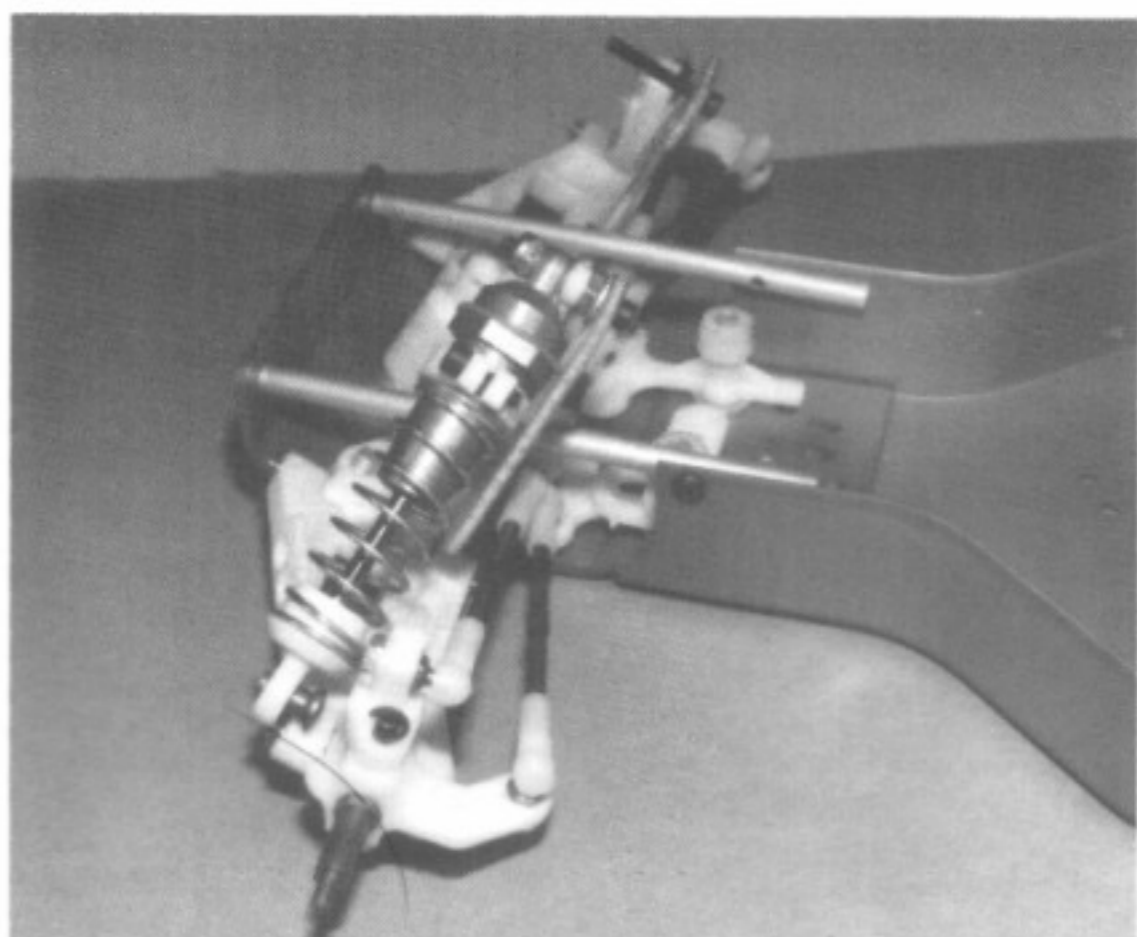

Fig. 130

□ **Fig. 131** The flat side of the ball should be towards the rear as the upper arrow shows. Now, back in Bag #6-1 you have 2 3/4" long screws that only have 1/4" of threads. Use these screws to mount the lower shock balls to the "A" arm, as shown.

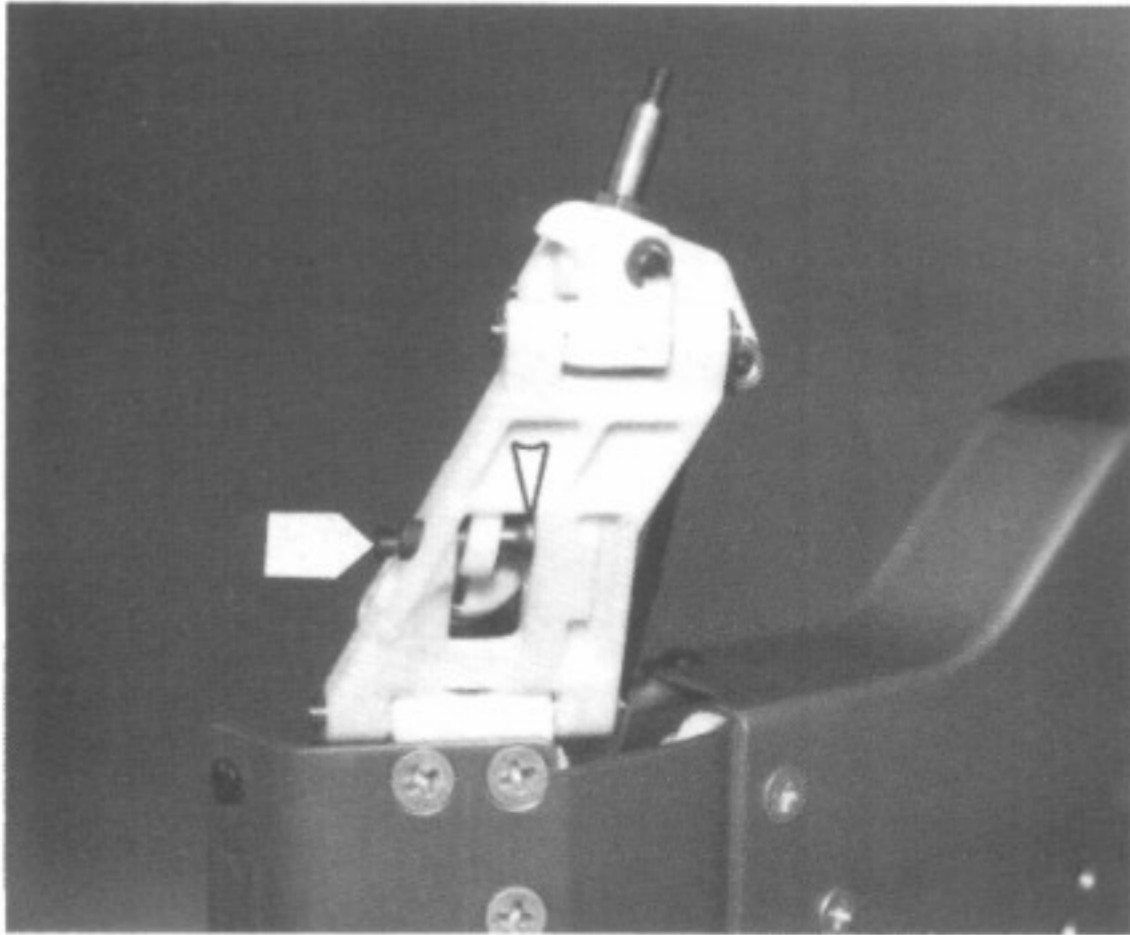

Fig. 131

□ **Fig. 134** These tubes tie in the nose piece very solidly to the chassis. Start by installing the rear screw through the side of the chassis, but do not tighten yet. Install the forward screw through the front of the nose piece into the end of the rod and tighten down. Now tighten the rear screw. Install the 2nd brace.

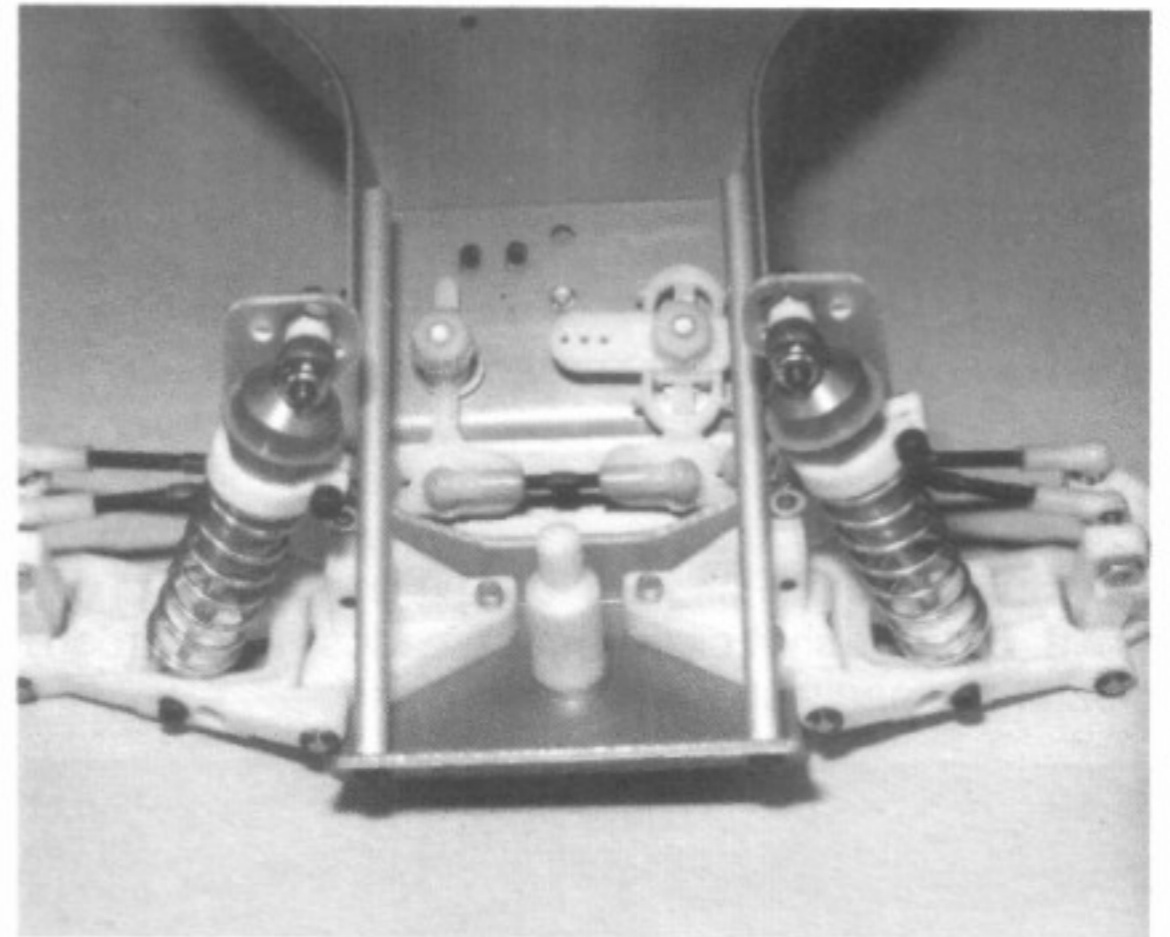

Fig. 134

□ **Fig. 132** Install the R.H. shock.

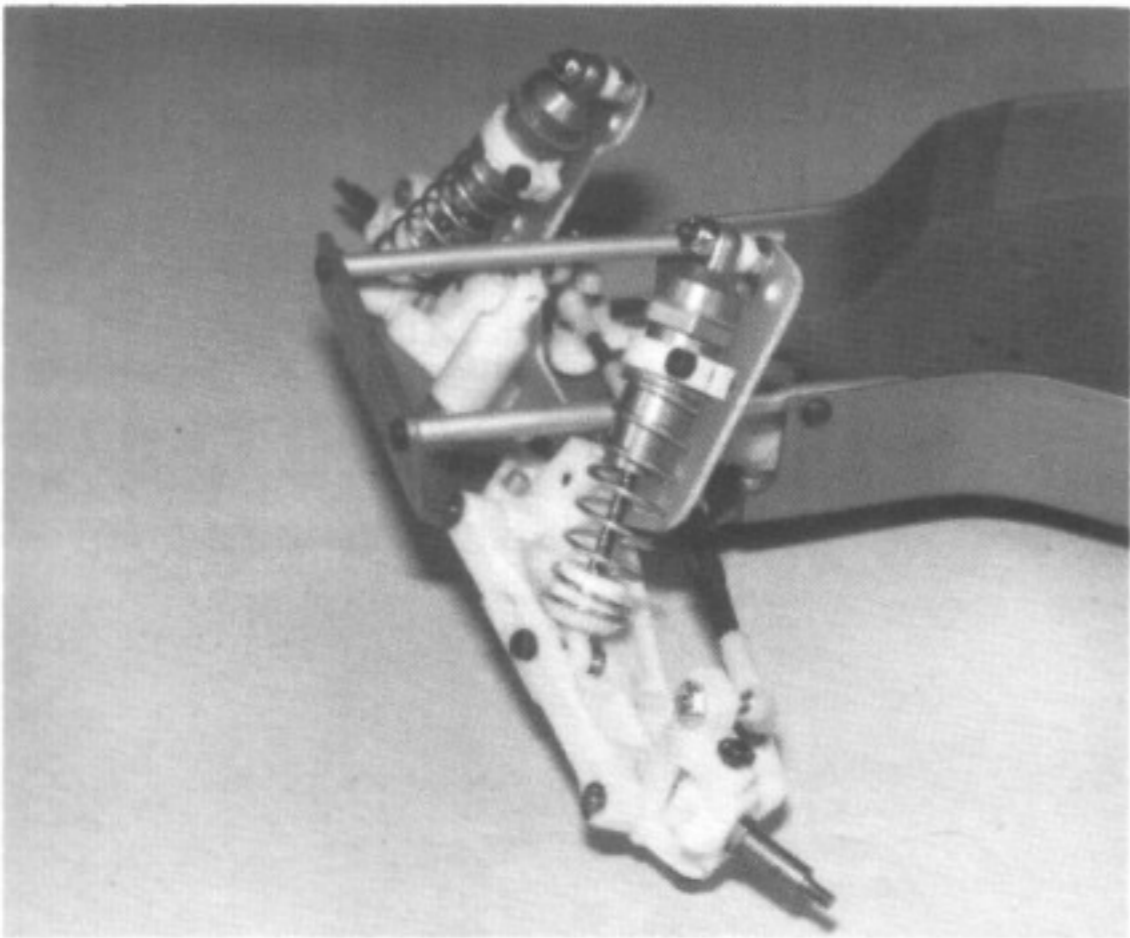

Fig. 132

□ **Fig. 133** In Bag #6-4 are the 2 #6320 nose brace tubes and 4 Allen button head screws, as shown.

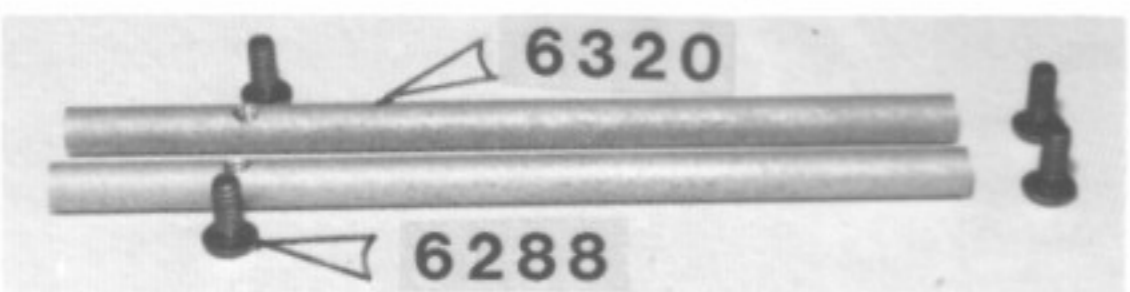

Fig. 133

□ **Fig. 135** Also in Bag #6-4 is the #6378 rear shock strut. Assemble this to the rear bulkhead with the 4 Allen screws, as shown.

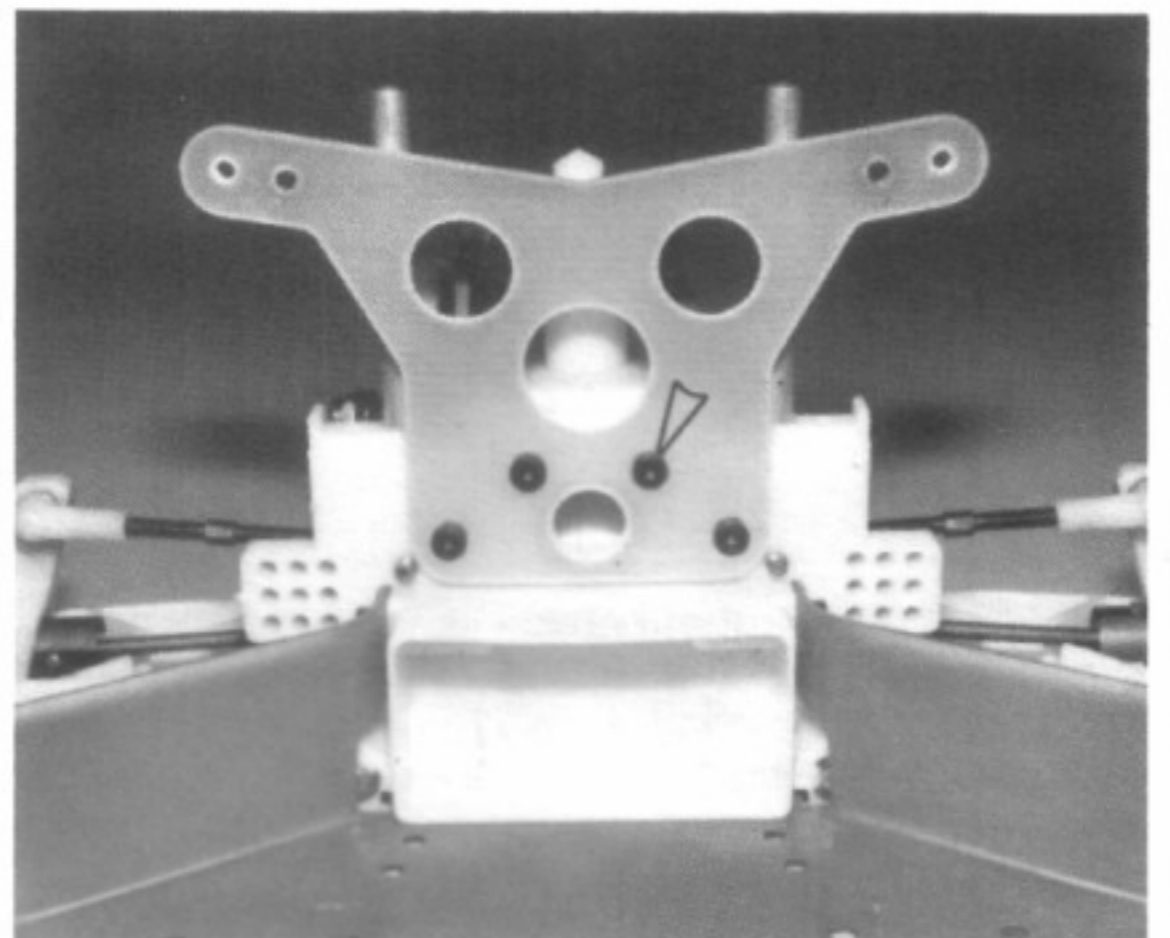

Fig. 135

□ **Fig. 136** It's time to install the rear shocks. From Bag #6-9, install one of the Allen screws through the fiberglass strut from the rear. Then, install a plain nut and an aluminum washer next. Slip a bushing in the shock, with the flange forward, and slip the shock on the screw.

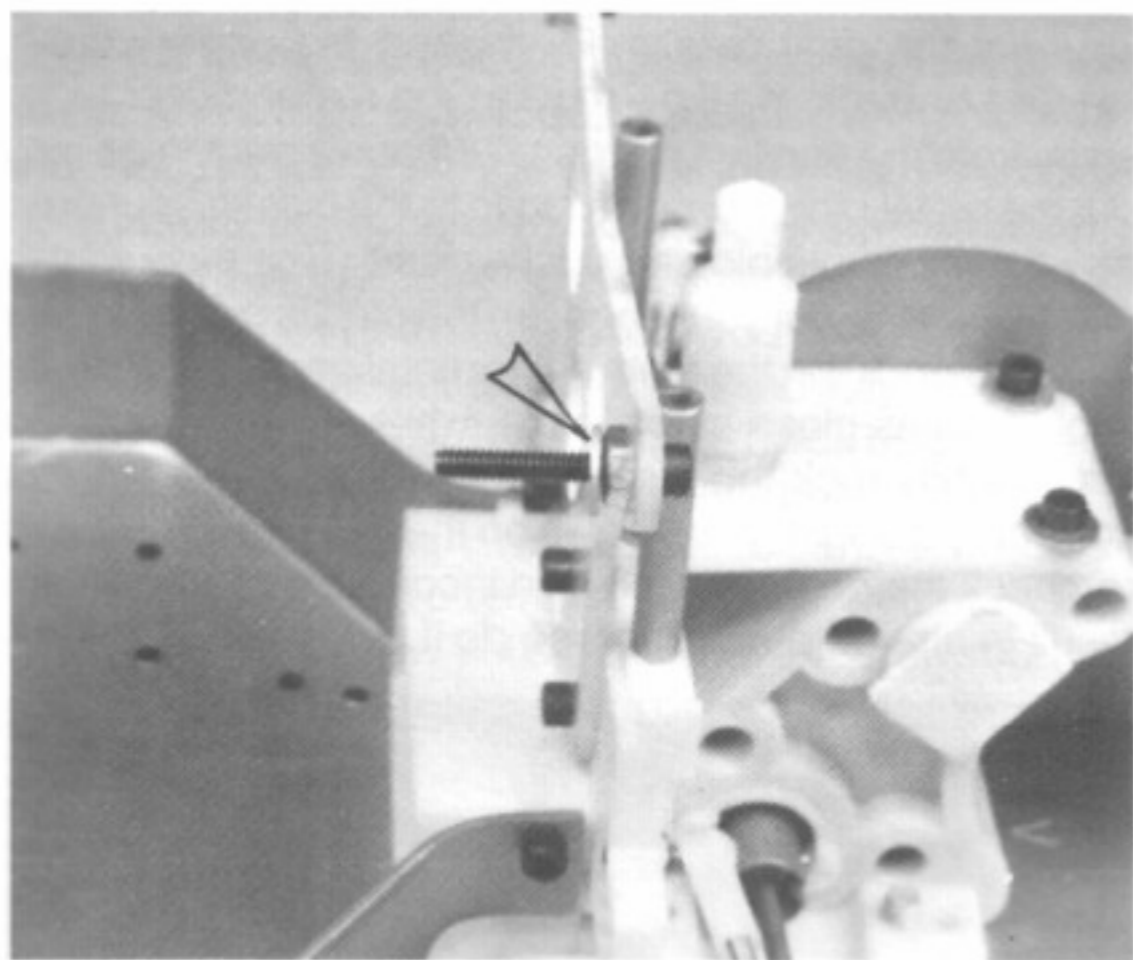

Fig. 136

□ **Fig. 137a** For the shock bottom installation we want the flat part of the metal ball end to be against the "A" arm, as shown. In the "A" arm, there are 4 holes. Install it in the outside hole, as shown. Slip a washer on the screw, and install the screw.

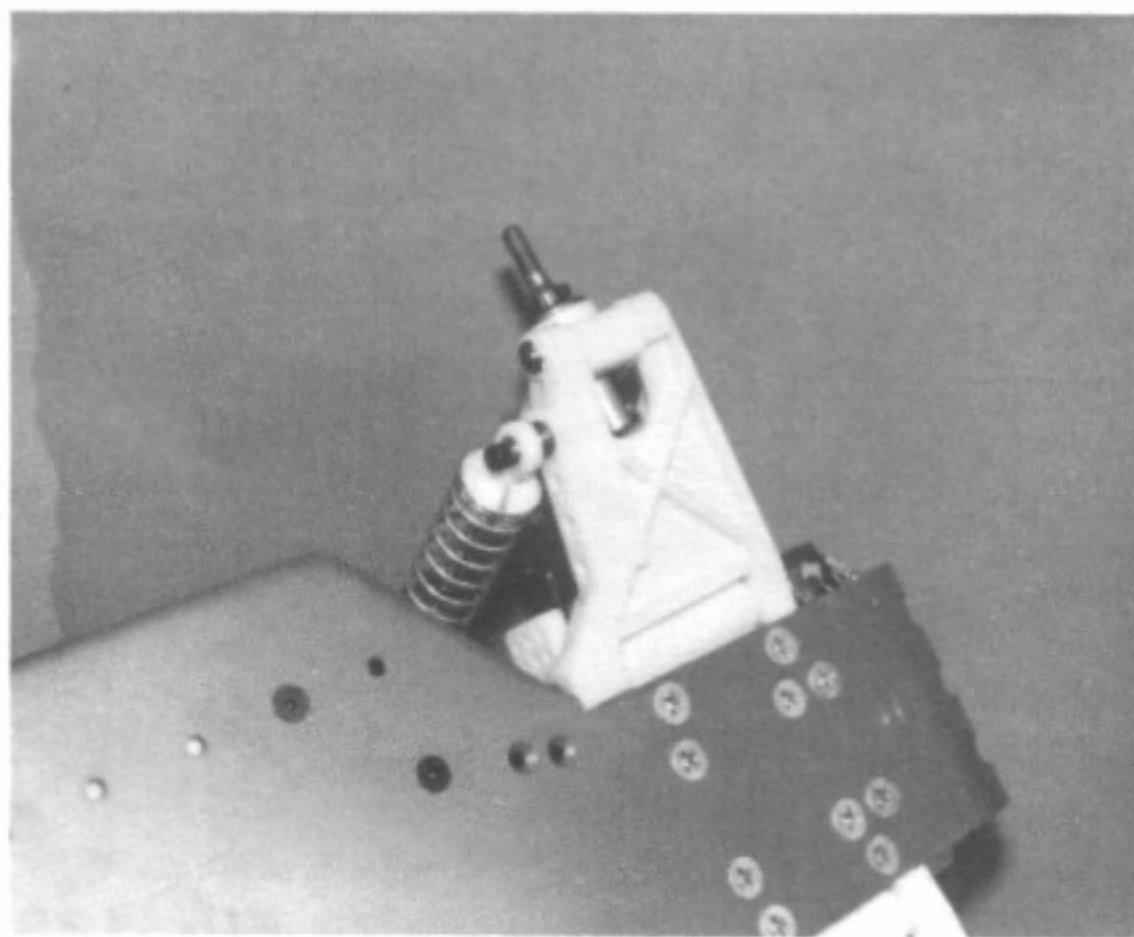

Fig. 137a

□ **Fig. 137** Install a locking nut next. Do not overtighten the nut, it is only necessary for the nut to take up the end play.

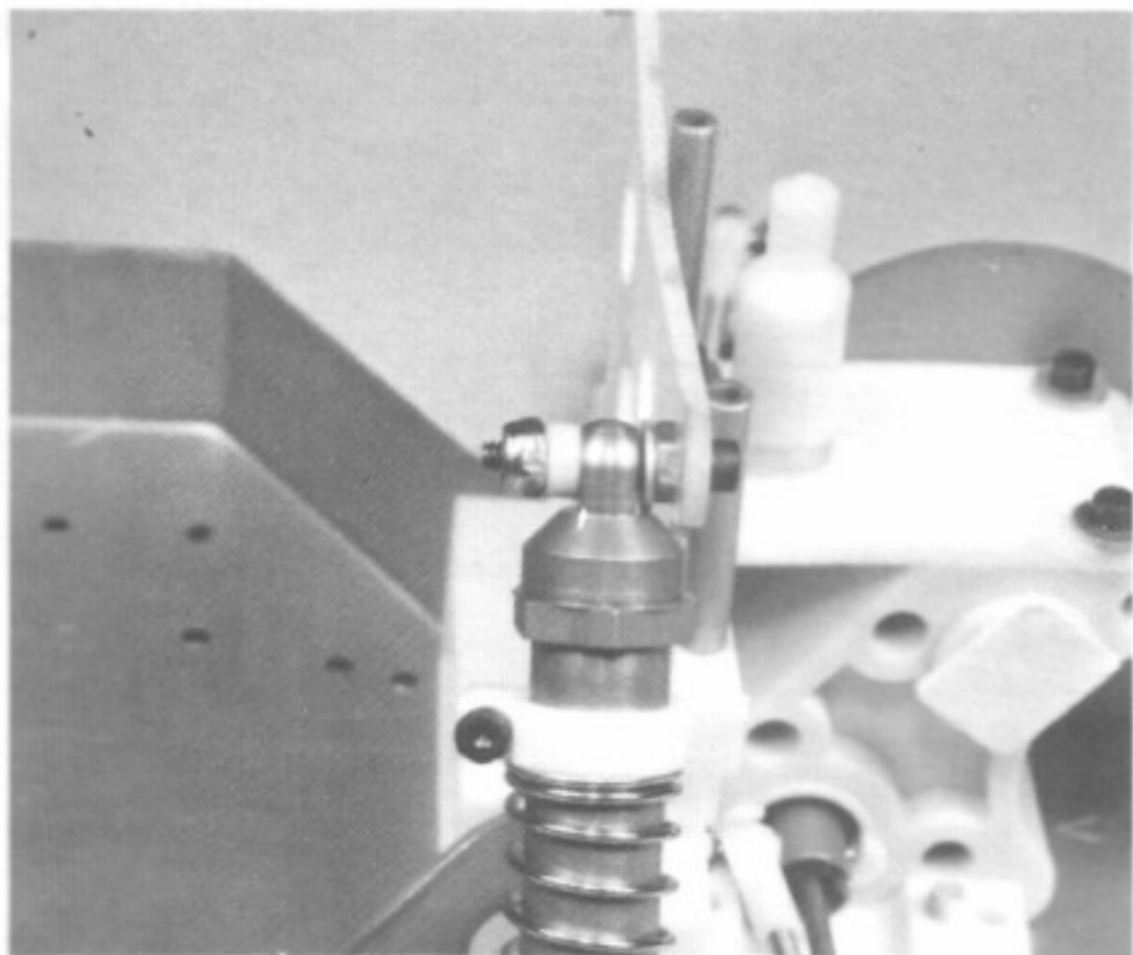

Fig. 137

□ **Fig. 138 & 138a** Time to put the horsepower in the car. Using ROSIN core solder, solder the motor lead wires and filter capacitors to the #6500 motor, as per the instructions included in the motor bag. From Bag #6-15, take the #6659 motor pinion and install the pinion, as shown. The end of the pinion should be even with the end of the shaft.

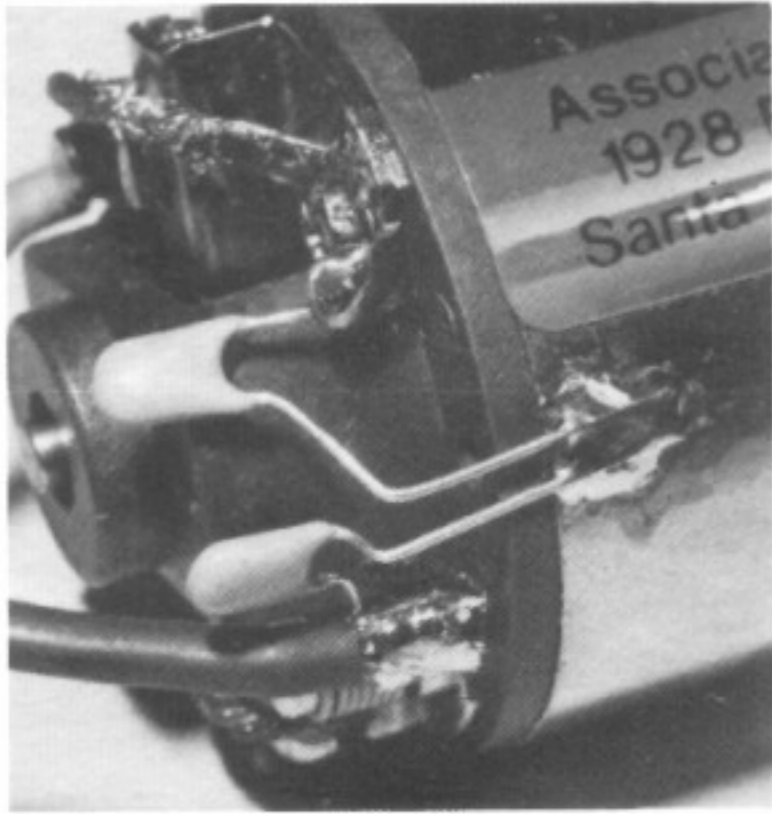

Fig. 138



Fig. 138a

□ **Fig. 139** In the motor bag are 2 metric motor mounting screws. These screws have finer threads and are ONLY used to mount the motor. Slip the motor in the motor mount and start the bottom screw in first. Do not tighten all the way down yet. On the top screw, put a washer on the screw and screw it in, but not tight. Now we'll set the gear mesh. By moving the upper screw, forward or back, we'll be moving the motor closer to, or away from the plastic spur gear. What we want to do is to get the metal pinion gear as close to the plastic spur gear as we can without binding up the gears. The easy way to check this is to put your finger on the plastic gear and see if you can rock it in the teeth of the metal gear. The 2 gears should be as close as possible, while still being able to very slightly rock the plastic gear. When you have this correct spacing, tighten down on the 2 motor screws and re-check the gear spacing. An incorrect gear mesh can result in a huge power loss, so do it correctly.

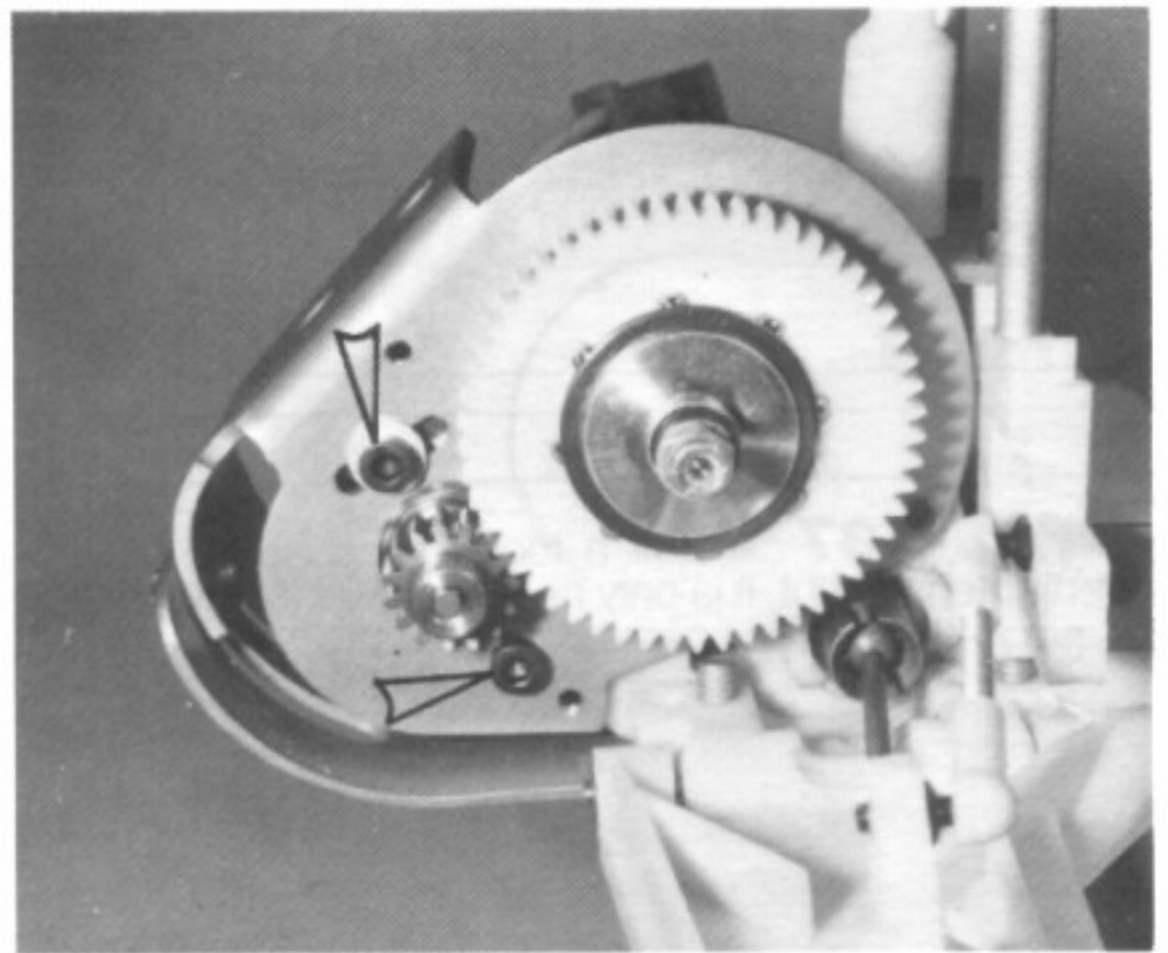

Fig. 139

□ **Fig. 140 & 140a** Now we'll install the #6608 dust cover, in Bag #6-12. You'll have to trim the dust cover to fit, with a scissors. But we want the dust cover to fold over the edges of the motor mount as far as possible. So slip the dust cover on, see where you have to trim and only cut off as much as you have to until you can snap the cover on. When the cover is on, you'll notice 2 indentations in the plastic where the 2 screws go. If you take an Xacto knife and twist it as you push, you can cut the 2 mounting holes in the plastic, or you can use a drill. You'll also have to cut a hole right in the center of the dust cover, by the dif adjusting nut, to fit the black button. You want the hole just big enough that the button will pop in and stay. When you want to adjust the dif, just remove the black button, make your adjustment, and reinstall the black button. Install the 2 mounting screws with washers, as shown.

CAUTION: To remove the motor, you must first remove the dust cover. You will then have 4 screws out that look the same. But if you mix up the dust cover screws with the motor screws, you will strip out the threads. Keep the motor screws with the motor, and the dust cover screws with the dust cover. Also, DO NOT try to use aluminum screws to attach the dust cover because they will break off in this installation.

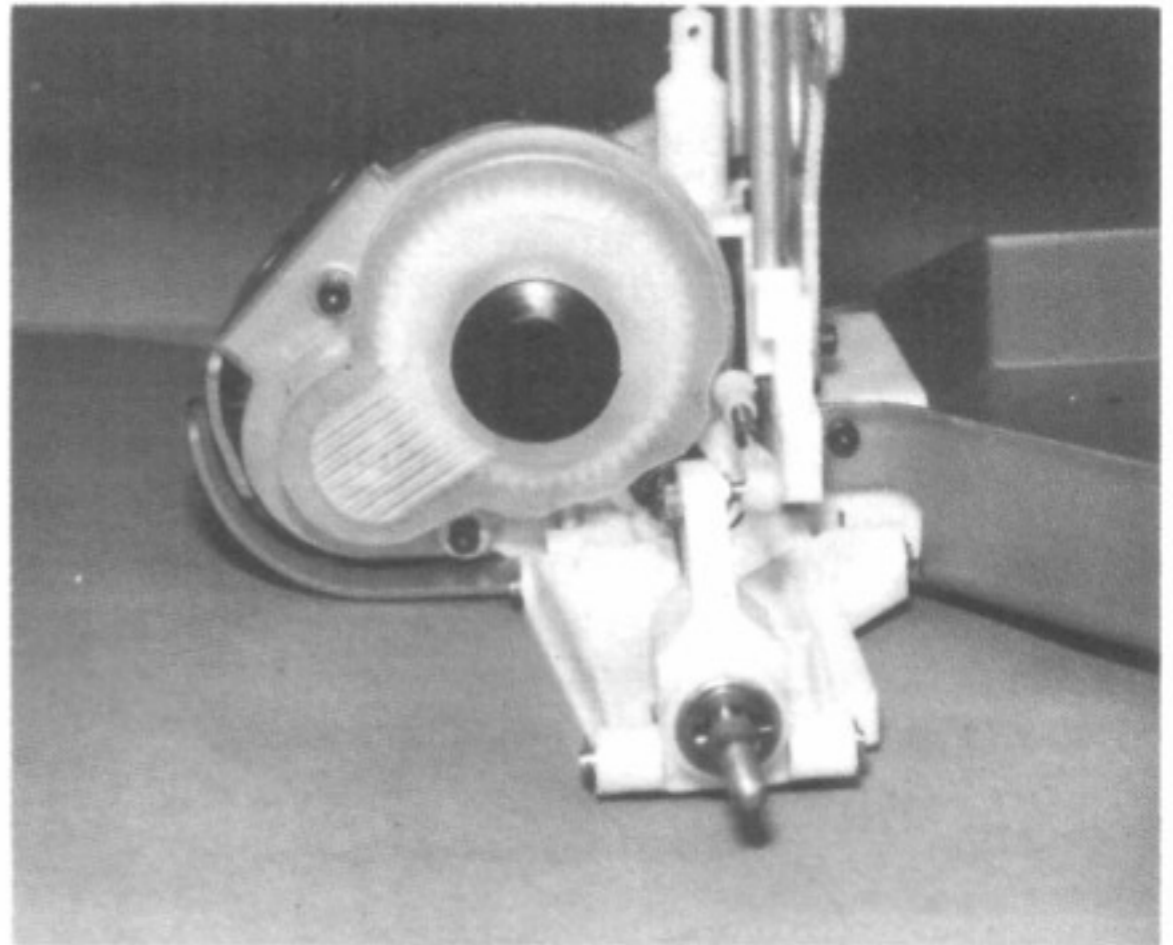

Fig. 140a

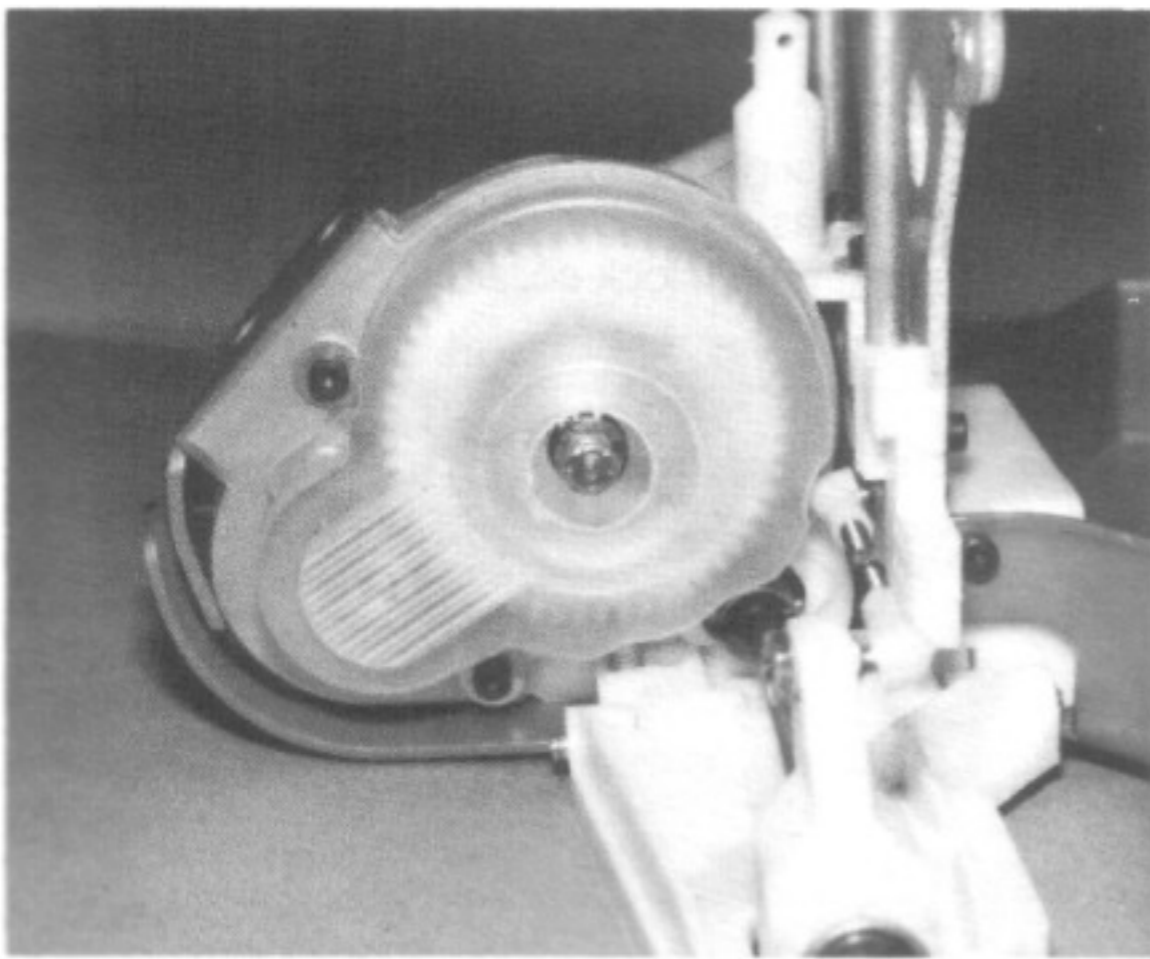

Fig. 140

RADIO INSTALLATION

We're ready to install the radio. If you haven't purchased a radio yet a good choice would be one of the 2-channel steering-wheel systems made by Futaba or Airtronics. However, many other radios, including stick models, can be used in the car. The higher torque medium sized servos (like the S31, S131, or S28) are preferred for steering, and small servos like the S32 are best for the throttle; but all three sizes, small, medium, and large, can be made to work. The photos that follow show the installation of a Futaba system with FP S32 servos. Special instructions and photos for other types of medium and large servos are also included. In these instructions servo sizes (the width of the case between the mounting ears but not including the ears) are grouped as follows:

SMALL (S32) : 1.5 in. (38mm)
 MEDIUM (S31) : 1.6 in. (41mm)
 LARGE (S29) : 1.8 in. (46mm)

STEERING SERVO

□ **Fig. 141** In Bag #6-6, take out 2 of the #6336 plastic servo mounts. You'll have to drill the mounts for your particular servos. If you have S32 servos, line up your servo with the mounts, so that there will be about 1/16" (1.6mm) clearance between the servo and the chassis plate and mark the hole locations on the mounts. Drill two #43 (2.3mm) holes in each mount on the side away from the chassis mounting hole, which will be on the bottom of the mount. You'll notice that the chassis has 2 sets of servo mounting holes. A short set and a long set. With 2 different sets and by rotating the servo mounts 90 deg, you will be able to mount most servos. Put the rubber grommets on the servo and attach the servo to the mounts with 4 button-head Allen screws and washers, as shown.

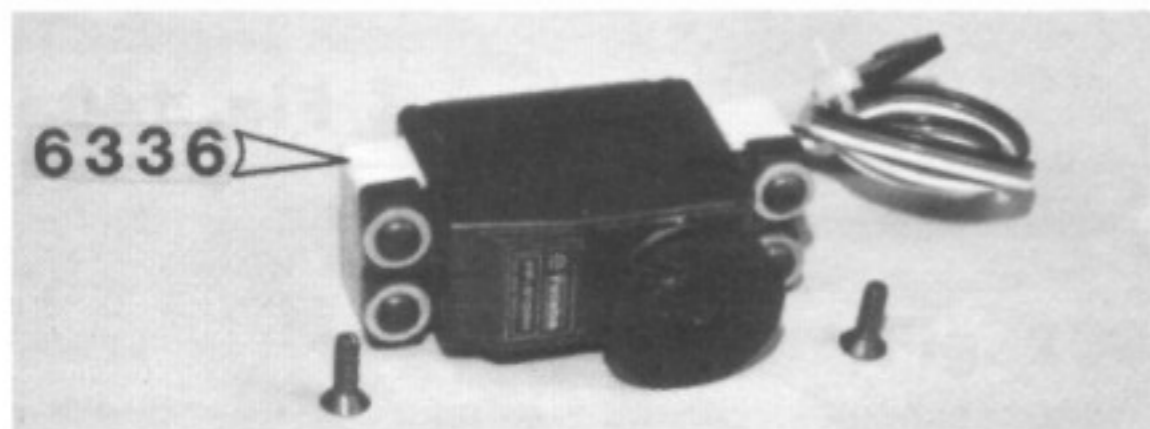

Fig. 141

□ **Fig. 142** Install the servo to chassis with the 2 flathead Allen screws shown in photo 141. You'll have to install 2 washers between the rear mount and chassis for proper alignment. Fig. 142a shows the proper holes to use with small servos.

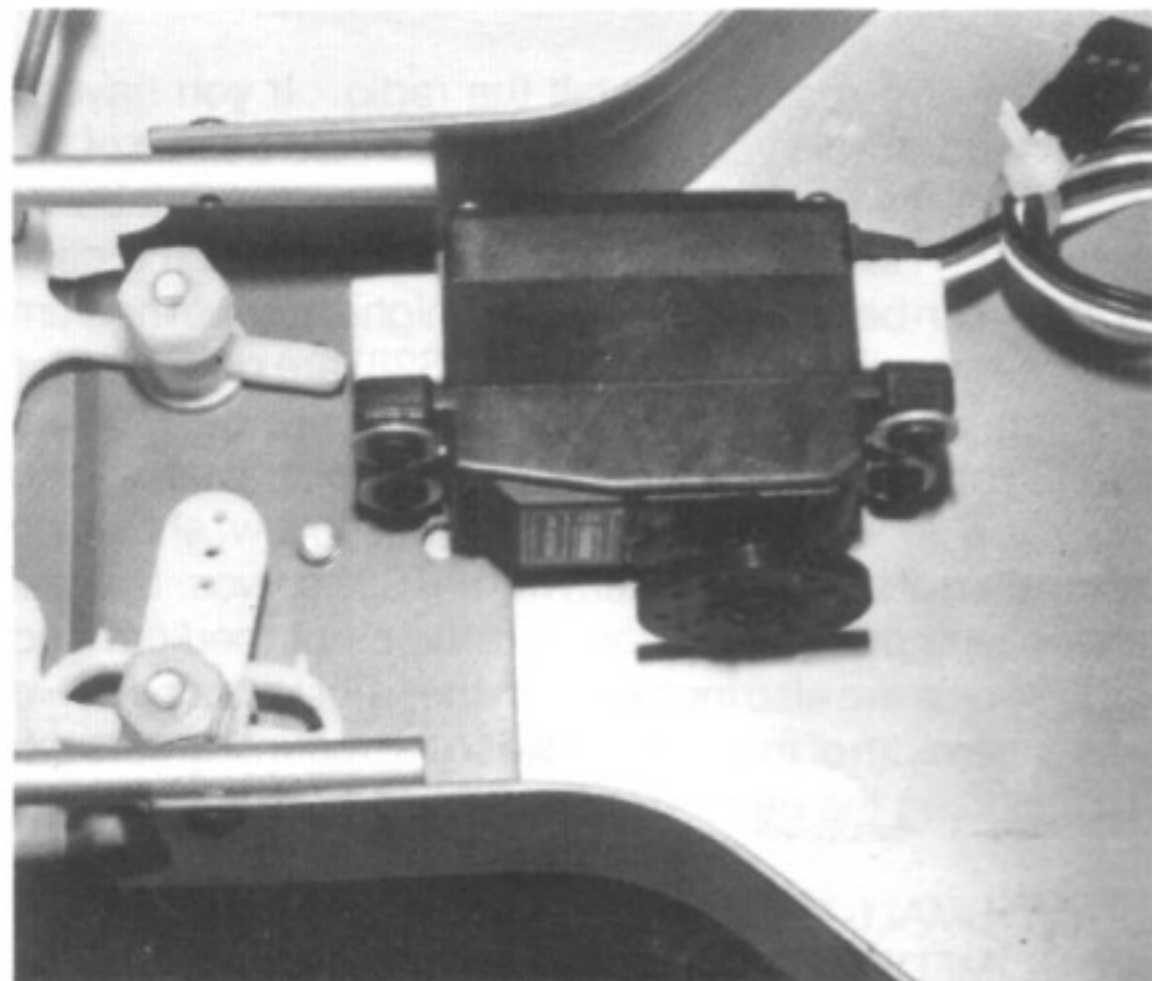

Fig. 142

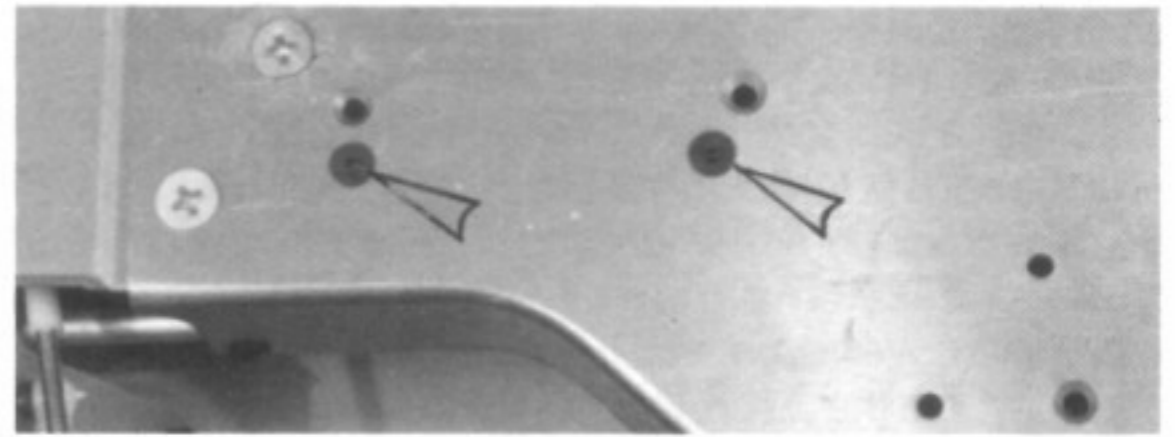

Fig. 142a

□ **Fig. 143** Out of Bag #6-2, take the piano wire linkage and set collars. Turn the servo output arm to the left and right stops and then center the arm between these 2 stops. It will not be exact, but it will be close enough for now. We'll center it exactly with the radio later. Slip one of the "Z" bend arms in the servo arm, as shown. The "Z" bend arm will be easier to install in the servo saver arm if you take your X-acto knife and rotate it in the hole to bevel it slightly. The arrow in the photo is pointing to a slight bend that we want to put in this wire to help clear the collars from the servo. Put a slight bend in the arm and then slip it in the center hole, as shown. Center the servo saver and install and tighten both lock collars.

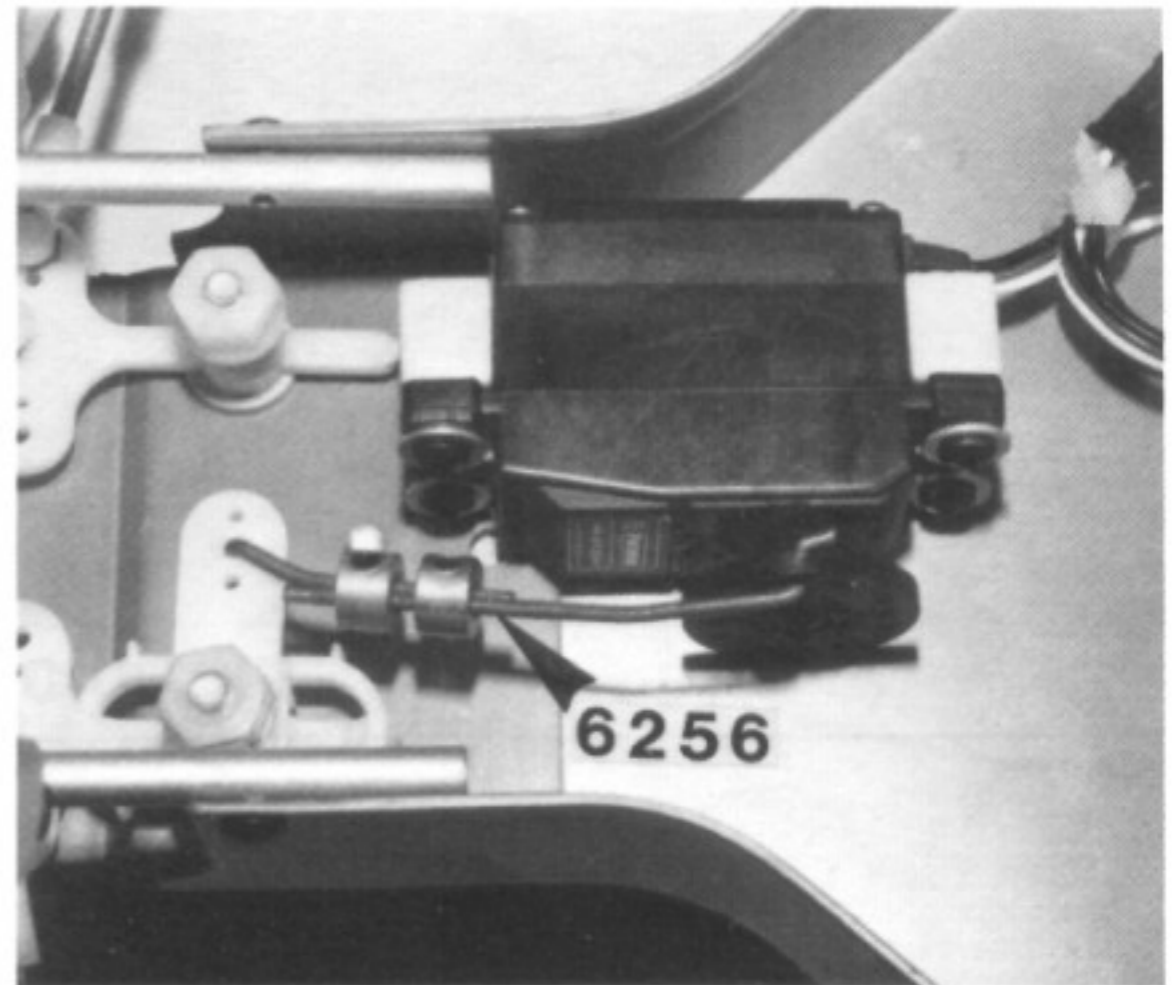

Fig. 143

Special Instructions - Medium steering servo

□ **Fig. 144** Medium sized servos would include Futaba S31, S131, S28; Airtronic 94461; and Novak NES1A. Follow the same procedure as for the small servo but use the wider spaced mounting holes in the chassis.

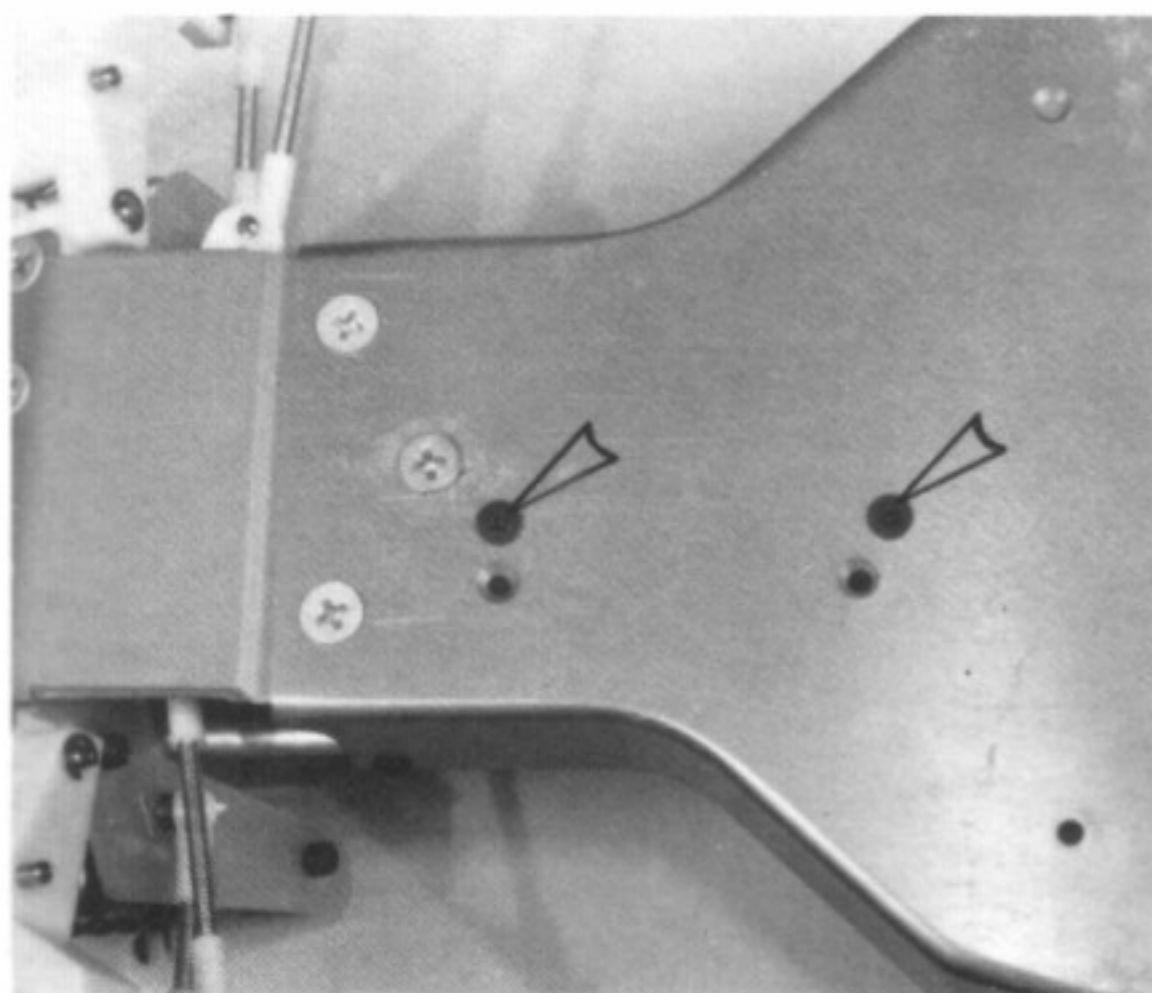

Fig. 144

Special Instructions - Large steering servo

□ **Fig. 146** Large servos would include Futaba S27, S29, as well as several older designs. Follow the instructions in step 141 except that the rear servo mount should be rotated 90 degrees as shown. This will move the mounting point well away from the existing holes in the chassis to make it easier to drill another hole. Temporarily install the front mounting screw, position the servo, and then mark round the rear mount as shown in Photo 146.

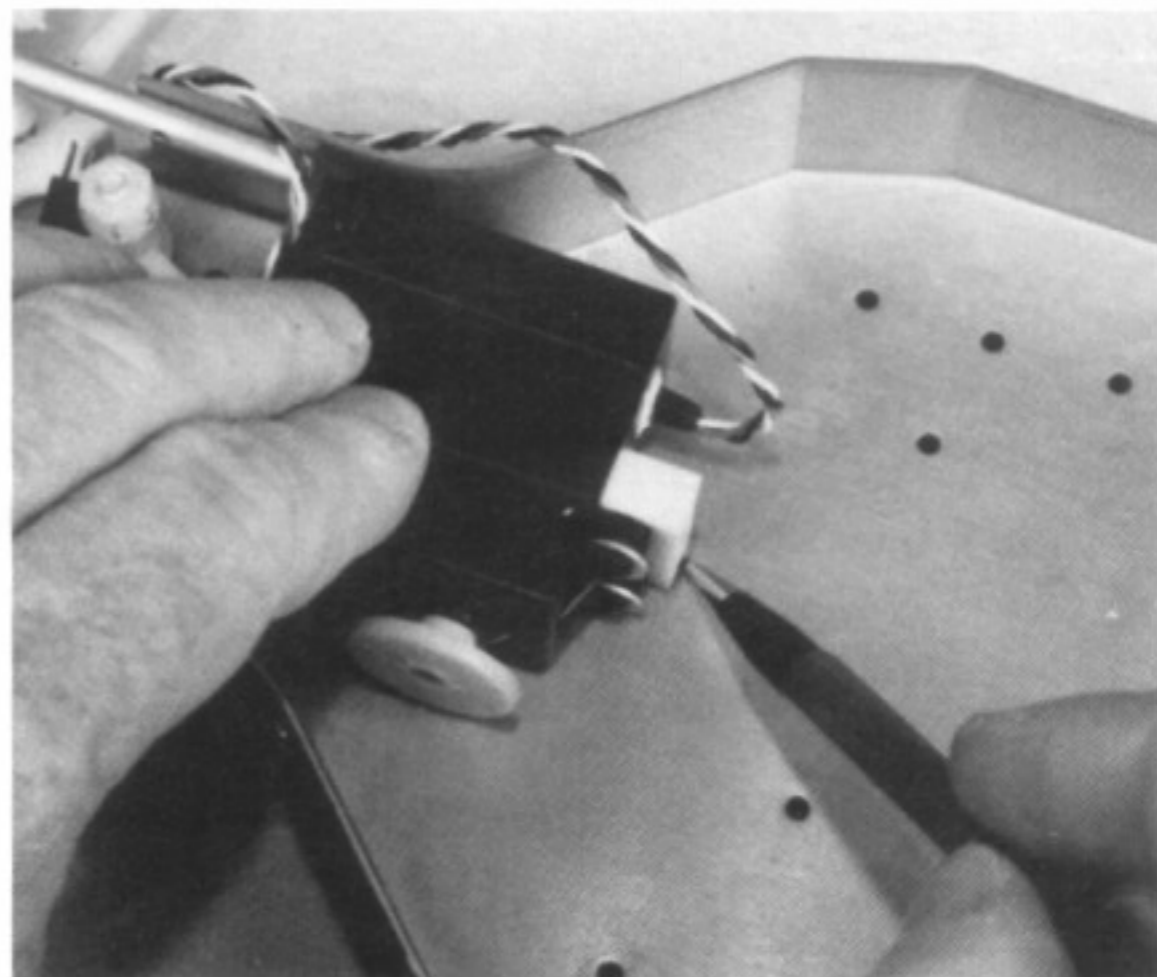

Fig. 146

□ **Fig. 145** Linkage is the same as for small servo but may require slightly more bend.

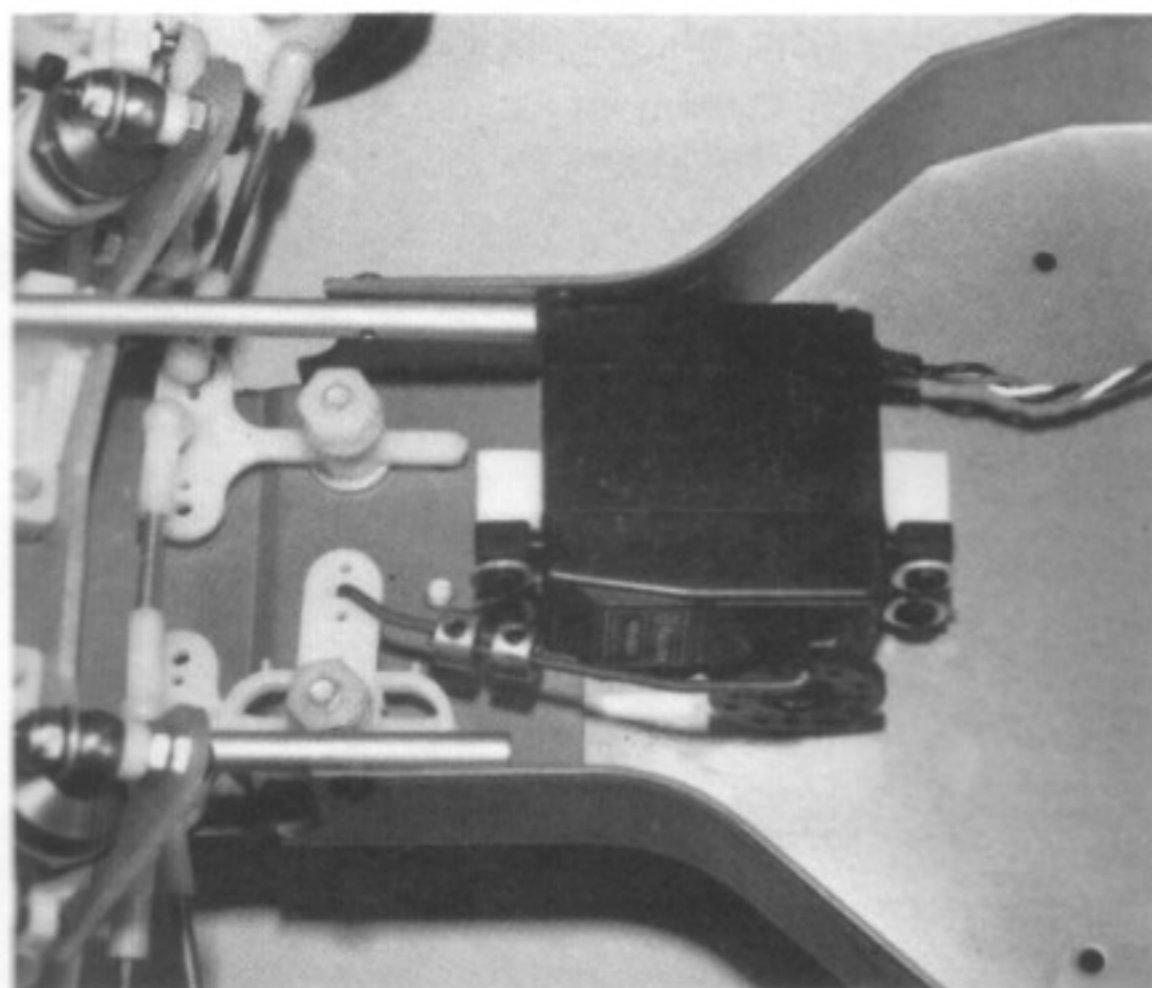

Fig. 145

□ **Fig. 147** Remove the servo and mark a spot to drill within the outline of the mounting block.

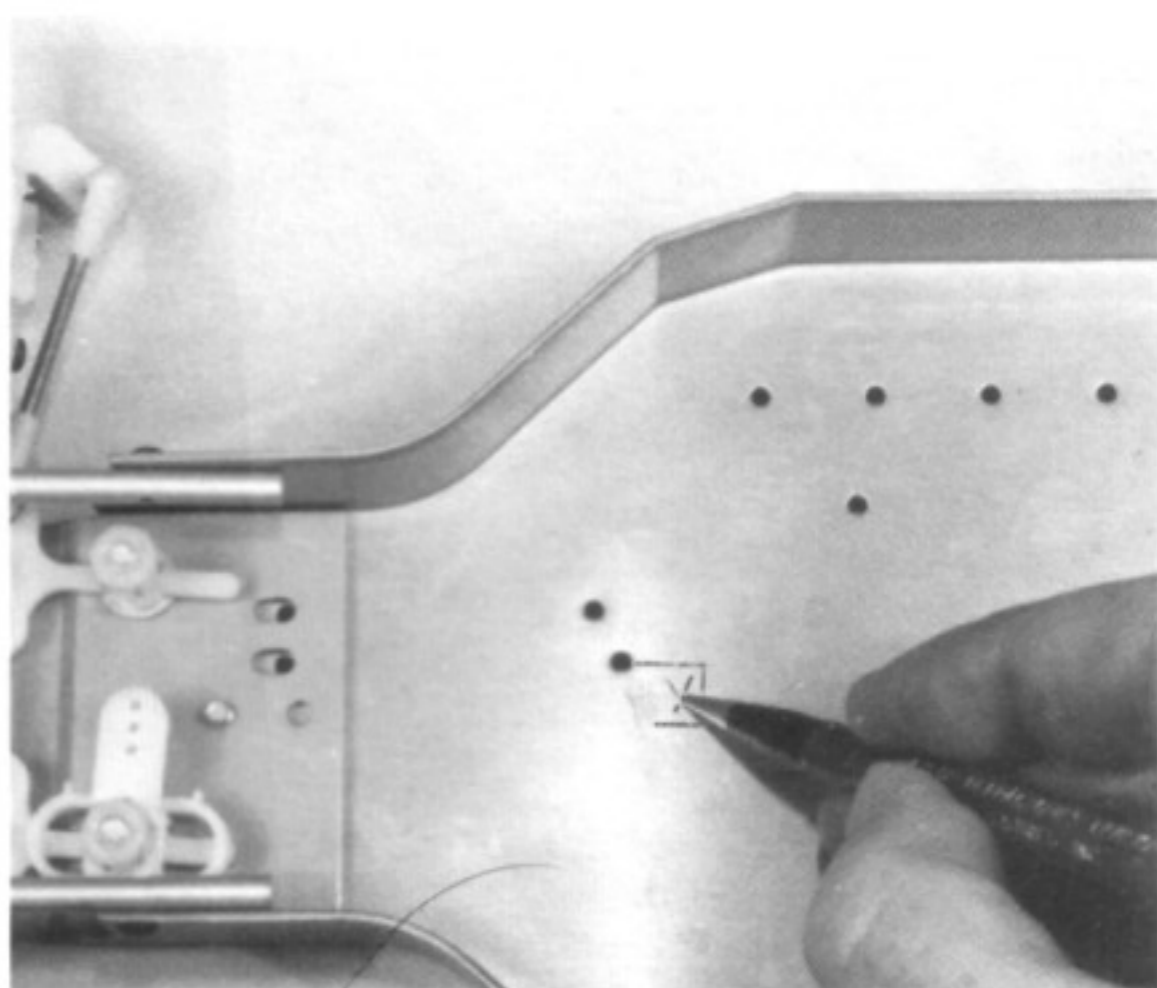

Fig. 147

Fig. 148 Center punch the mark and drill the chassis with a 1/8" (3.1mm) drill. Countersink the hole on the bottom of the chassis if possible. You can use a large (approx. 3/8") drill and turn it by hand to do the countersinking.

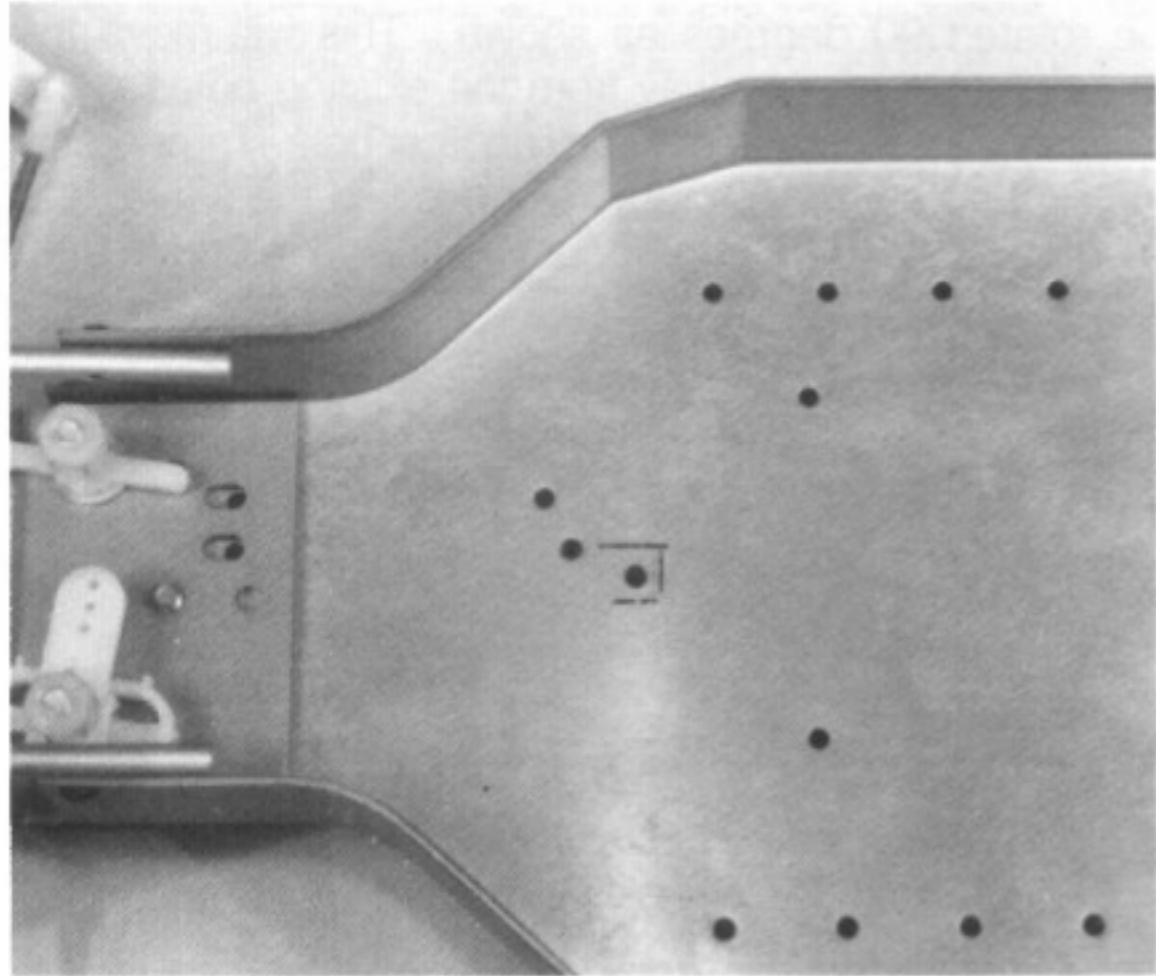

Fig. 148

THROTTLE SERVO

Fig. 150 The throttle resistor servo shown here is an S32. Assemble the servo mounts, as you did in step 141, except this servo is placed in the direction shown.

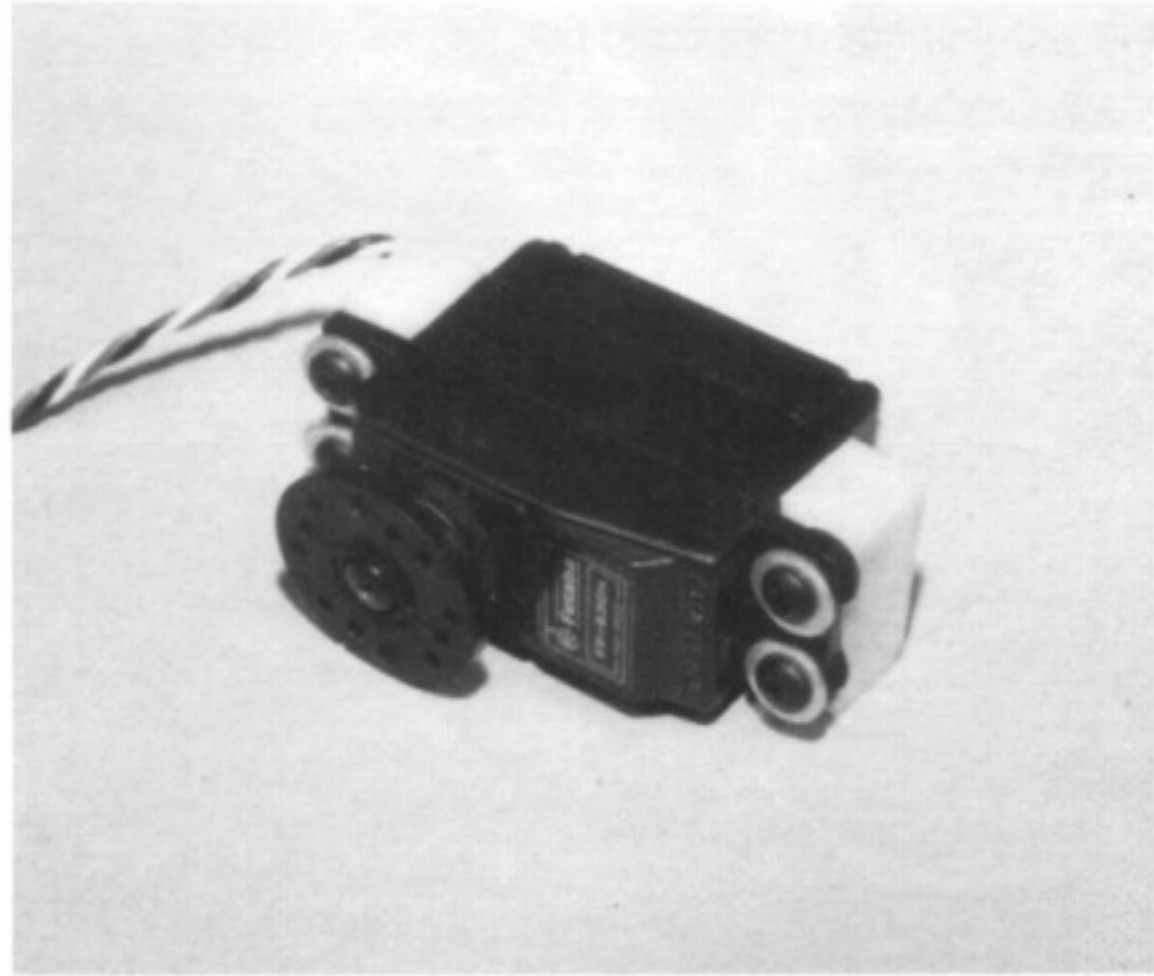

Fig. 150

Fig. 149 Mount the servo and install the linkage following steps 142 and 143. Bend the linkage wire as shown in Photo 149.

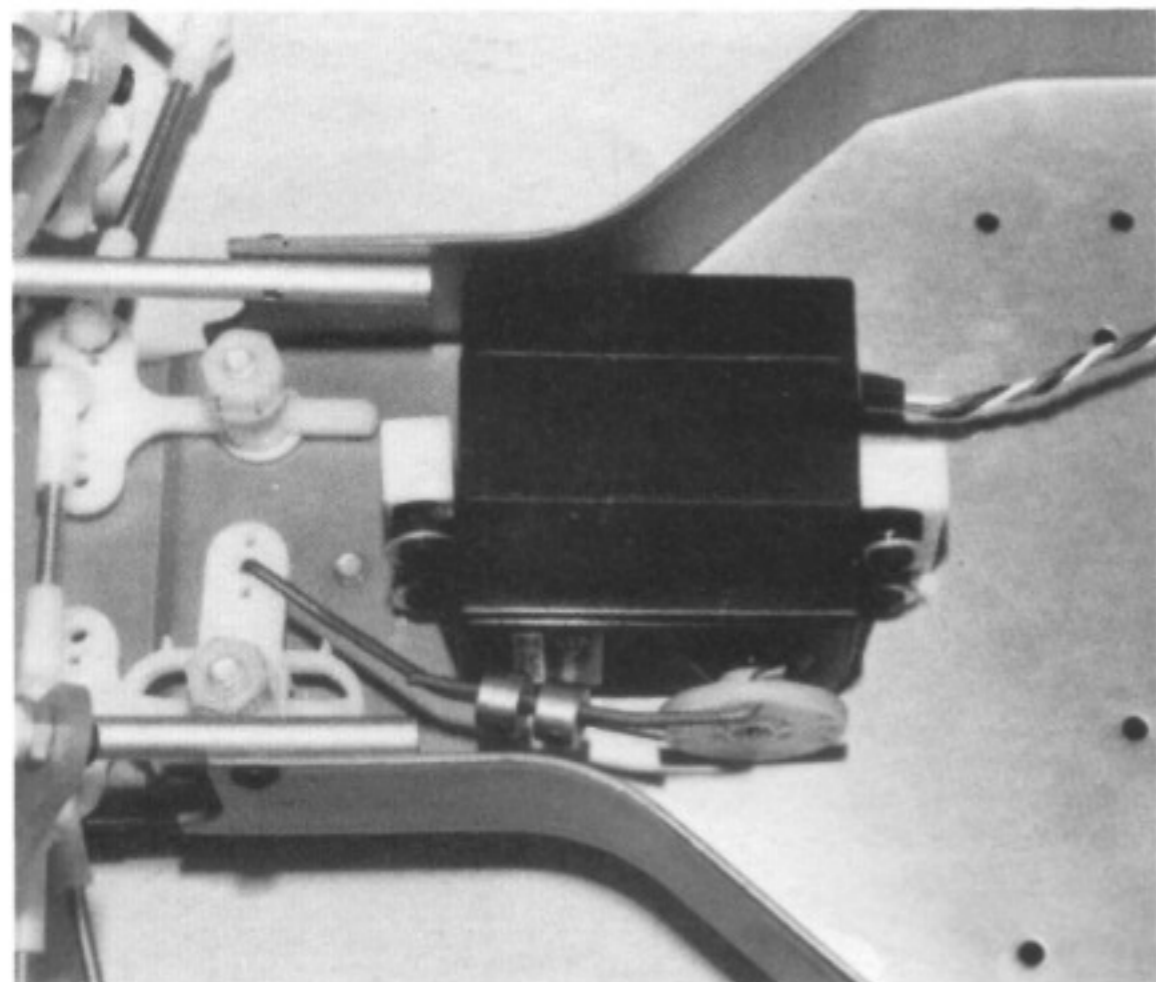

Fig. 149

Fig. 151 Install the servo to chassis, as shown. It is important that the servo mount high enough to allow the servo wheel to clear the chassis by about 1/8" (3.1mm). Add washers under the mounts if necessary to give the required clearance.

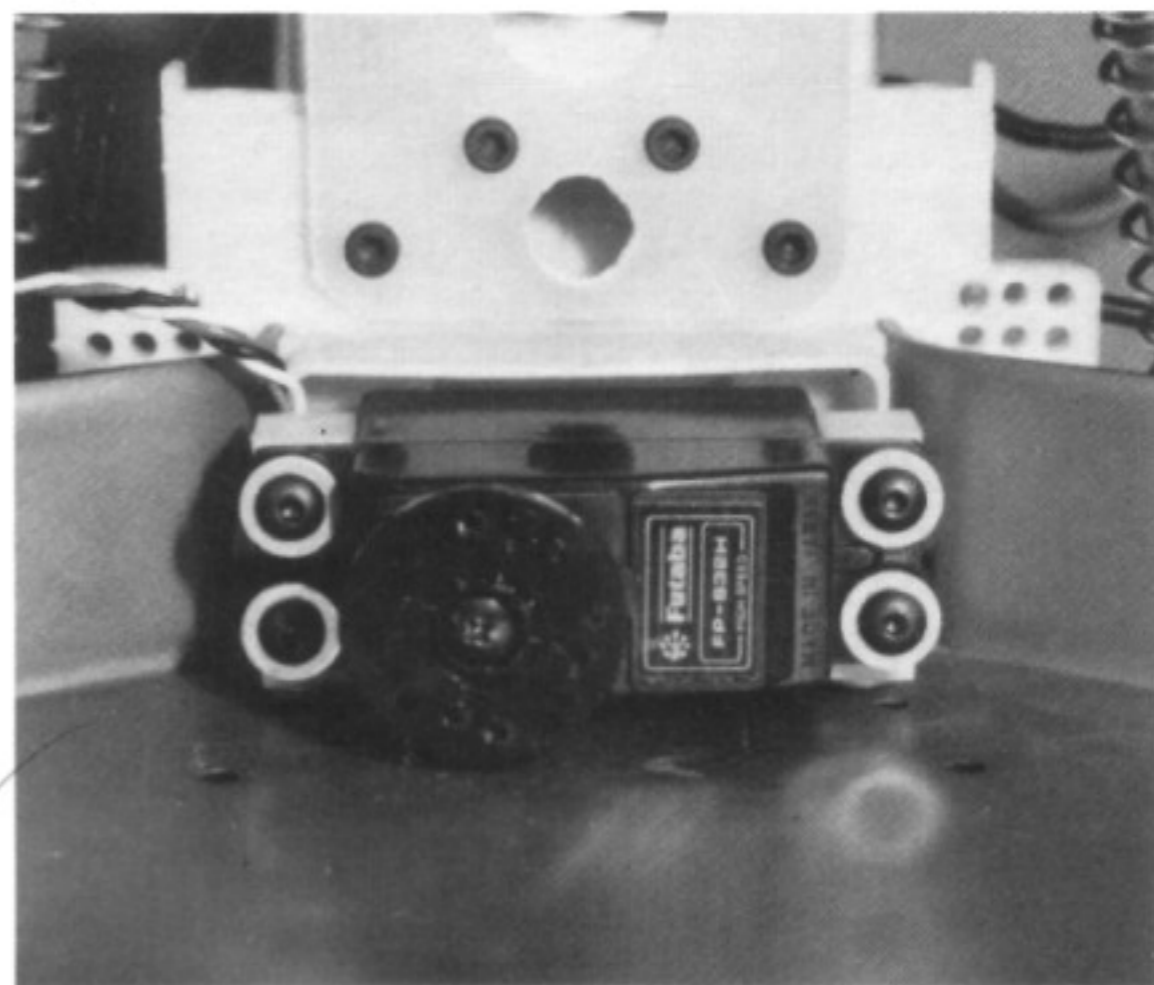

Fig. 151

□ **Fig. 152** From Bag #6-13, install the 2 #6713 resistor brackets with 2 flathead Allen screws and locknuts, as shown. Note that the brackets will be turned differently if you are installing a medium or large servo (see special instructions that follow later).

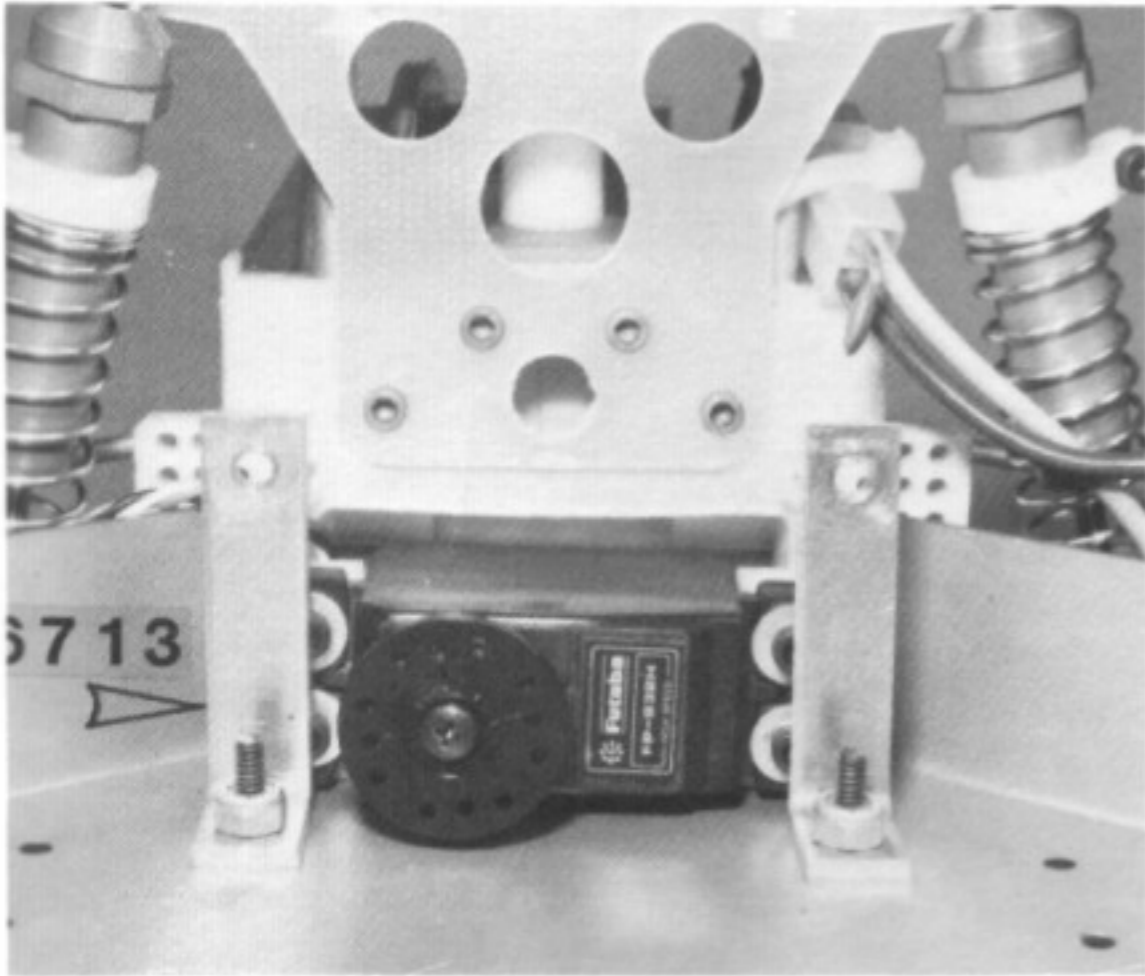

Fig. 152

□ **Fig. 153** Slip the aluminum resistor mount through the #6711 resistor and attach it with a short 4-40 screw and locknut to the R.H. side of photo, as shown. On the other side, where arrow is pointing, install the plastic bypass mount with the longest screw going into the recessed hole, as shown, with a locknut. There are two plastic bypass mounts. Use the thicker mount with the square edges if you are mounting a small (S32) sized servo. For a medium or large servo the resistor brackets must be turned differently and the thinner bypass mount with rounded edges (and possibly dyed a color) should be used.

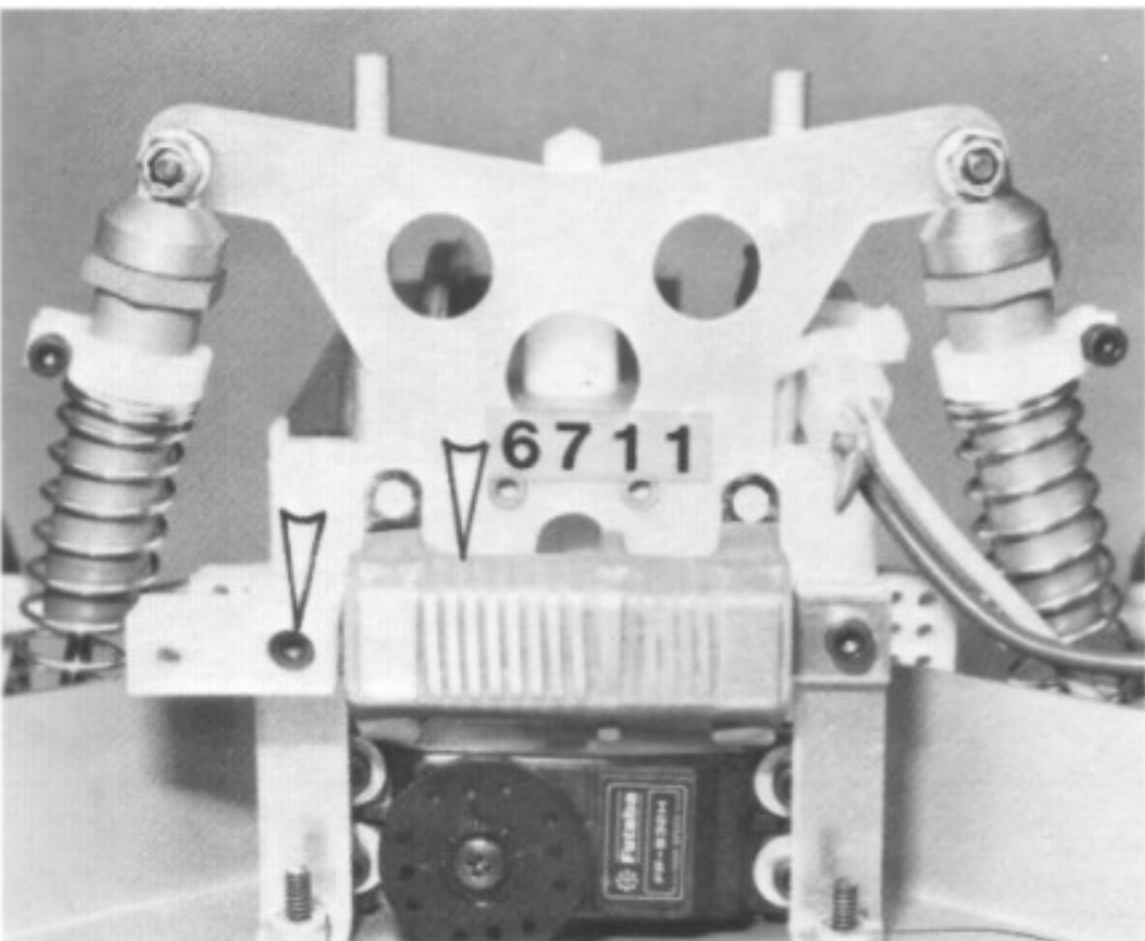

Fig. 153

□ **Fig. 154** In the end of these instructions is a full page detailed drawing of the wiring installation. We'll use that page to help clarify the installation. Attach the correct wires to the resistor per the drawing, and make sure the wire lengths are the same as in Photo 179. If you put the wires through the holes and bend them around they'll stay while soldering. Use only rosin core solder and solder both connections, as shown. All these wire connections **MUST BE** soldered.

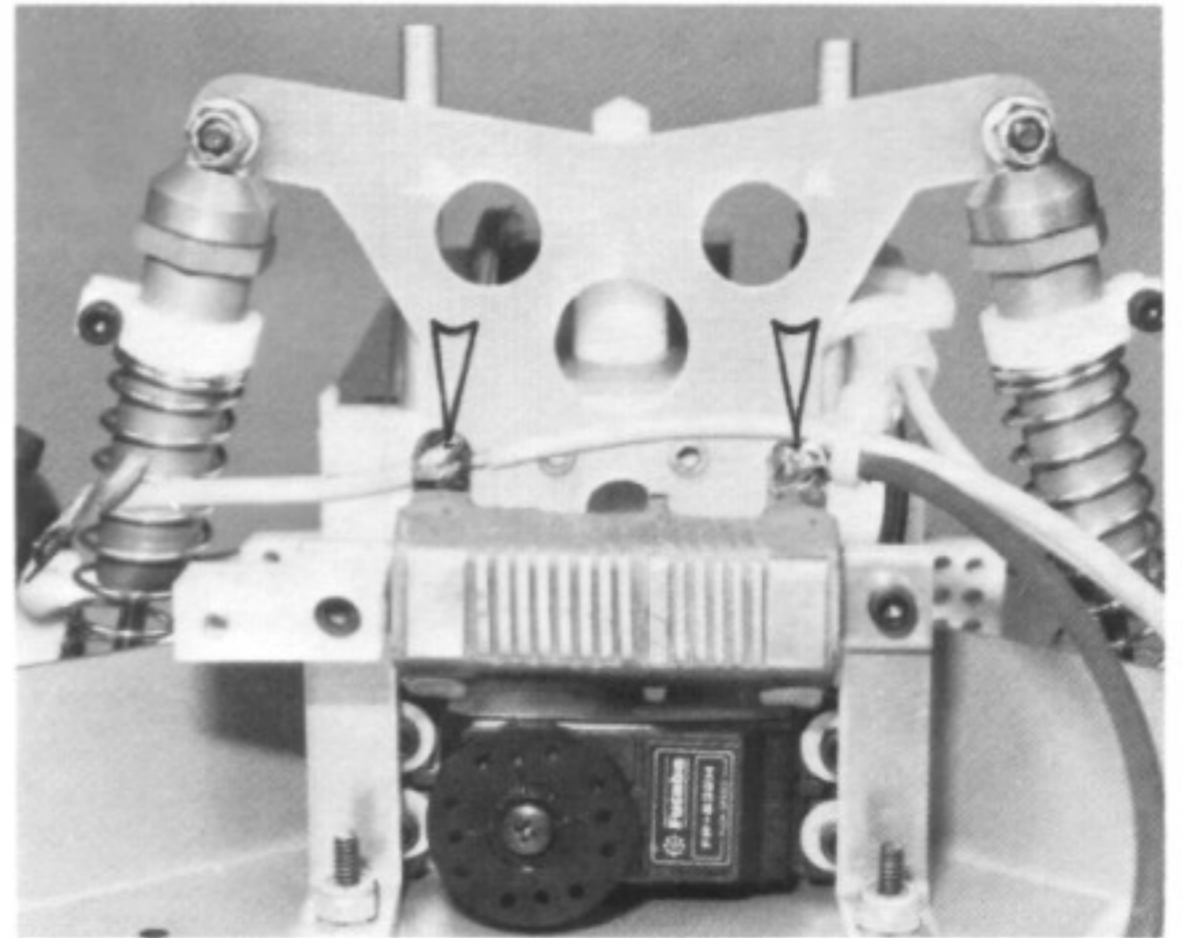

Fig. 154

□ **Fig. 155** (Next page.) Center the servo output arm, as before, then turn it about 30 deg to the right of photo. Locate the wiper arm so that it is in the exact location shown and note the closest holes in the servo wheel to mount the wiper. Solder the wire to the resistor in the exact location shown in the photo. Mount the resistor arm to the servo arm in the exact position shown. If your servo wheel has a raised center then use the small washer to stand the wiper off from the edge of the wheel (see Photo 168).

This next item is **VERY IMPORTANT**. The resistor brass button must push quite hard against the resistor to make a good contact. If it does not have enough pressure the motor will not operate to its fullest horsepower and you will burn out the resistor. An easy way to check this is to take the fingernail from your smallest finger and lift the button a very small amount off the resistor. If it lifts off quite easily, it's too soft. It should pull quite hard on your fingernail, **BEFORE** it lifts off - then it's correct. Bend the arm if necessary to achieve this.

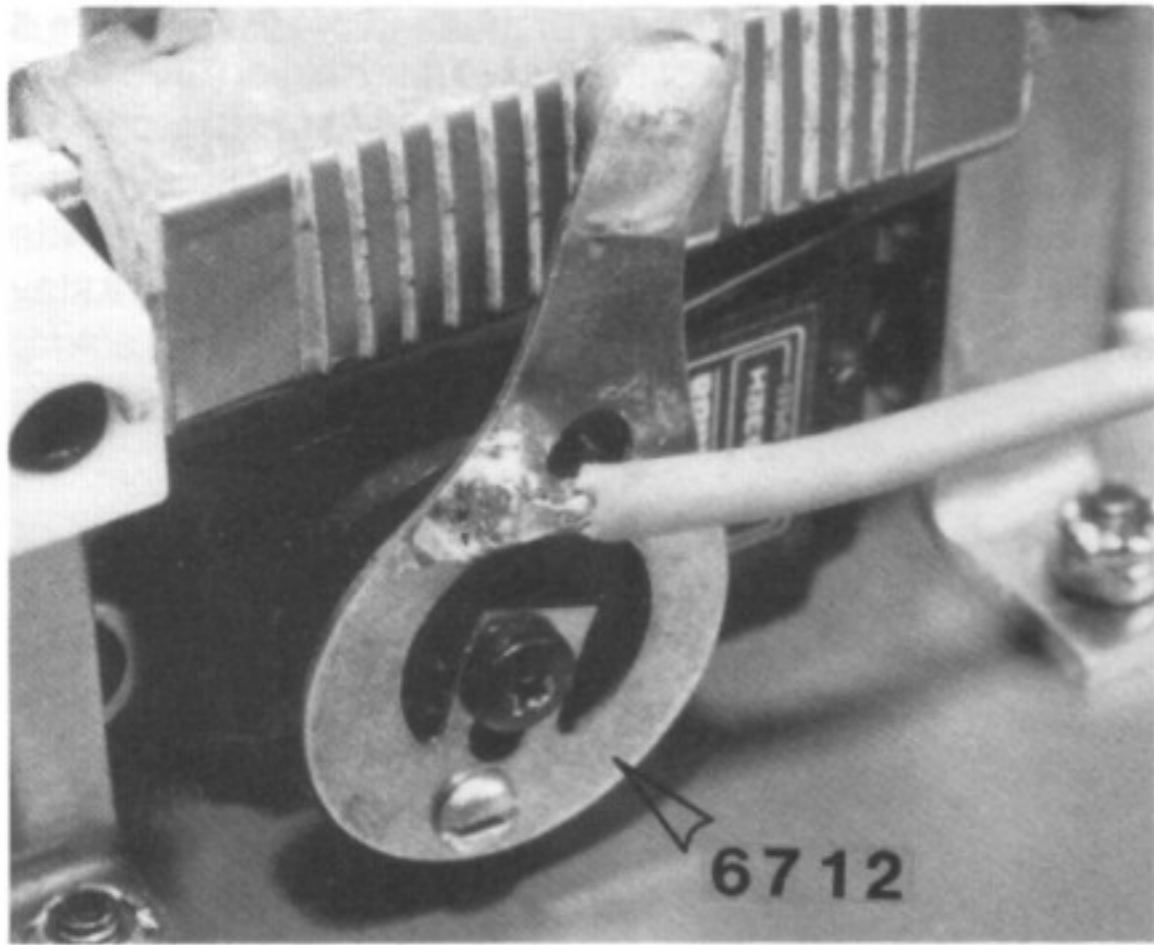

Fig. 155

Fig. 157 These are the mounting holes you should use.

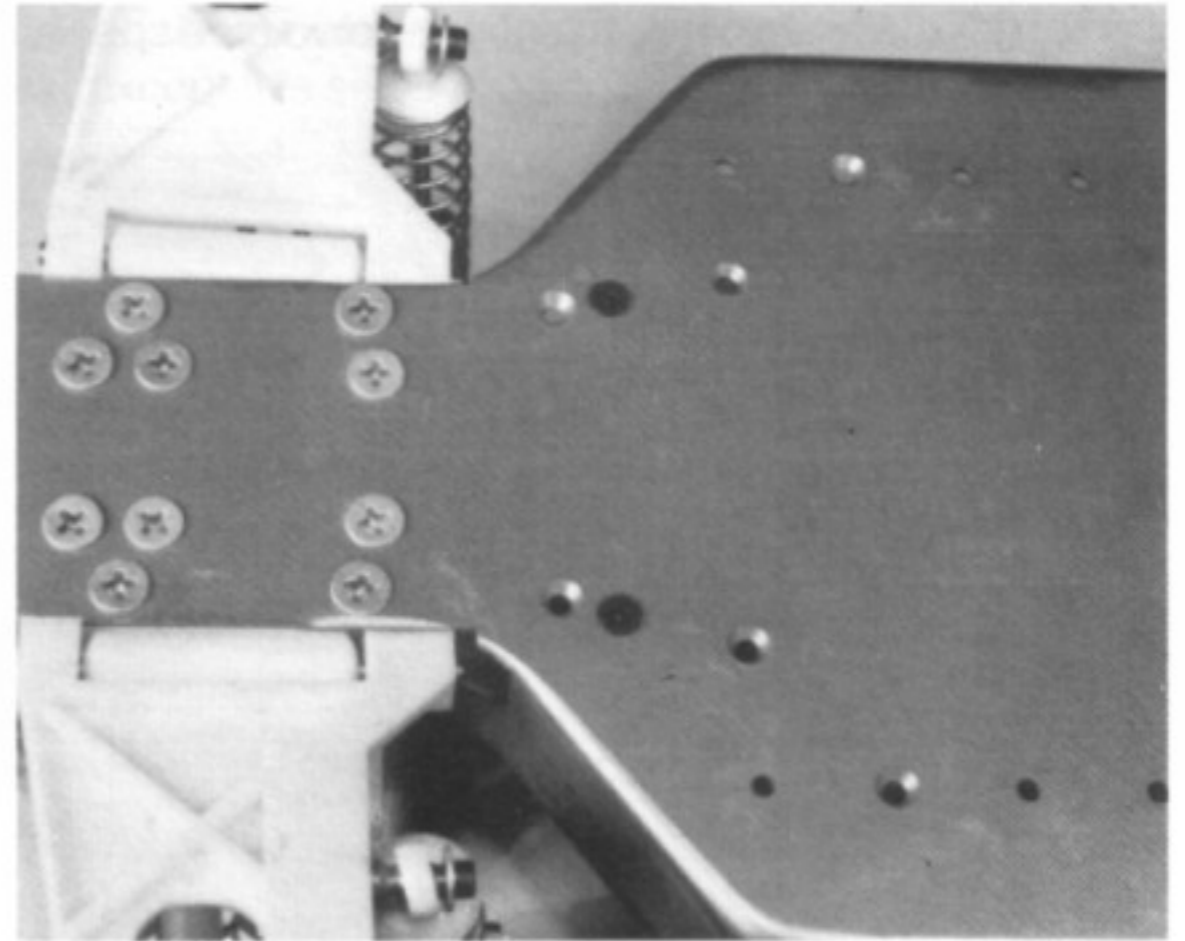

Fig. 157

Special Instructions - Medium throttle servo

Fig. 156 See page 35 for a description of servo sizes. Do the following steps to mount a medium sized throttle servo. Install the servo mounts to the chassis temporarily, using the wider spaced mounting holes.

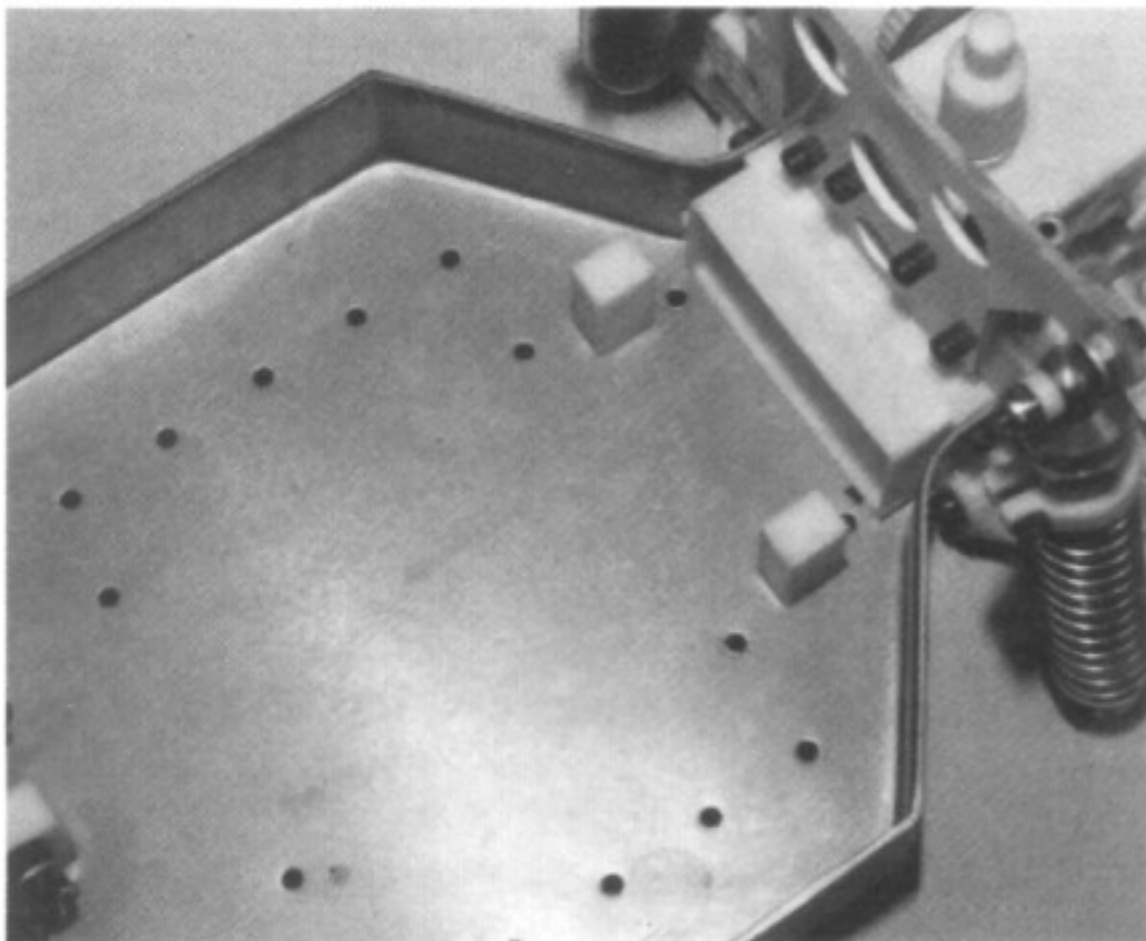

Fig. 156

Fig. 158 Drop in the servo and space it off the chassis with a resistor bracket as shown. Mark the servo mounts with a pencil. Remove the mounts from the chassis and drill the mounts as in step 141. Install the mounts to the servo. Make sure the servo is turned so that the output shaft is on the correct side.

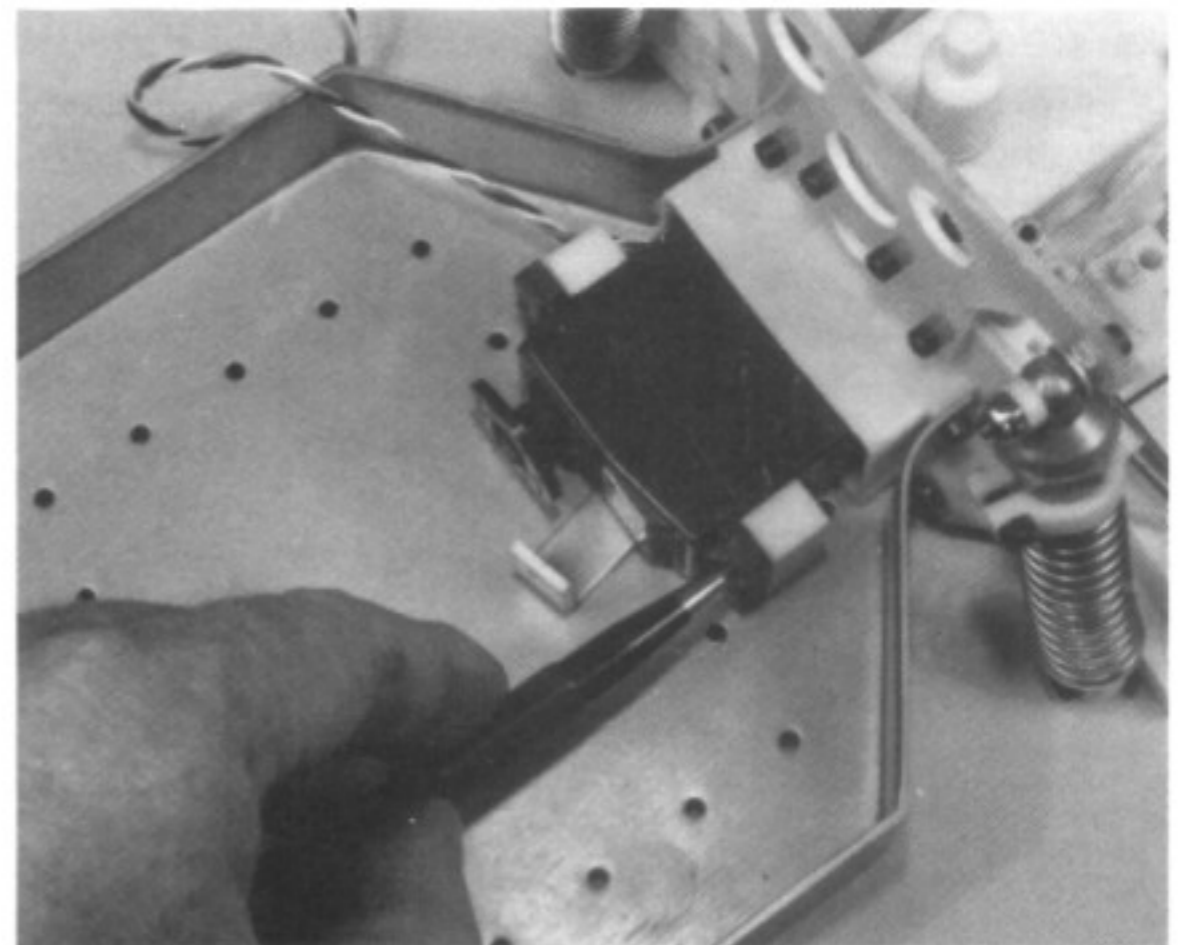

Fig. 158

Fig. 159 Install the servo to the chassis as shown. It is important that the servo wheel clear the chassis by about 1/8" (3.1mm). Use washers under the mounts to achieve the required clearance. Also, some servos (the S28 for instance) are very deep and may bottom out against the bulkhead, making alignment with chassis holes difficult. In this case you should put washers between the mounts and the servo to space the servo away from the bulkhead.

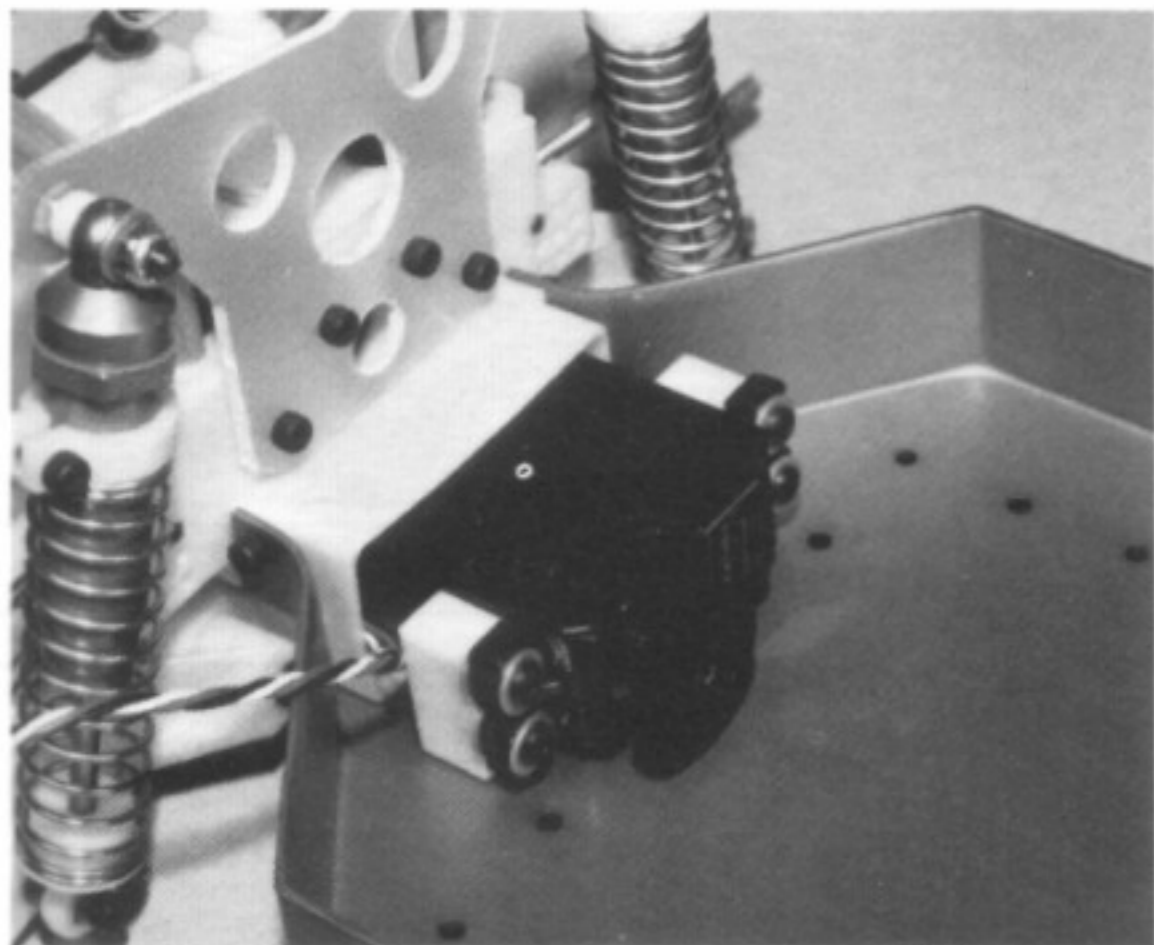

Fig. 159

Fig. 161 Follow steps 152 and 153 to install the throttle resistor, but make the following exceptions: the resistor brackets should be turned 180 degrees, so that they look like Fig. 161. Mount the resistor BEHIND the brackets instead of in front; and use the thin bypass mount (with the rounded edges). When assembled check for proper wiper pressure as in step 155 and complete with wiring in step 154.

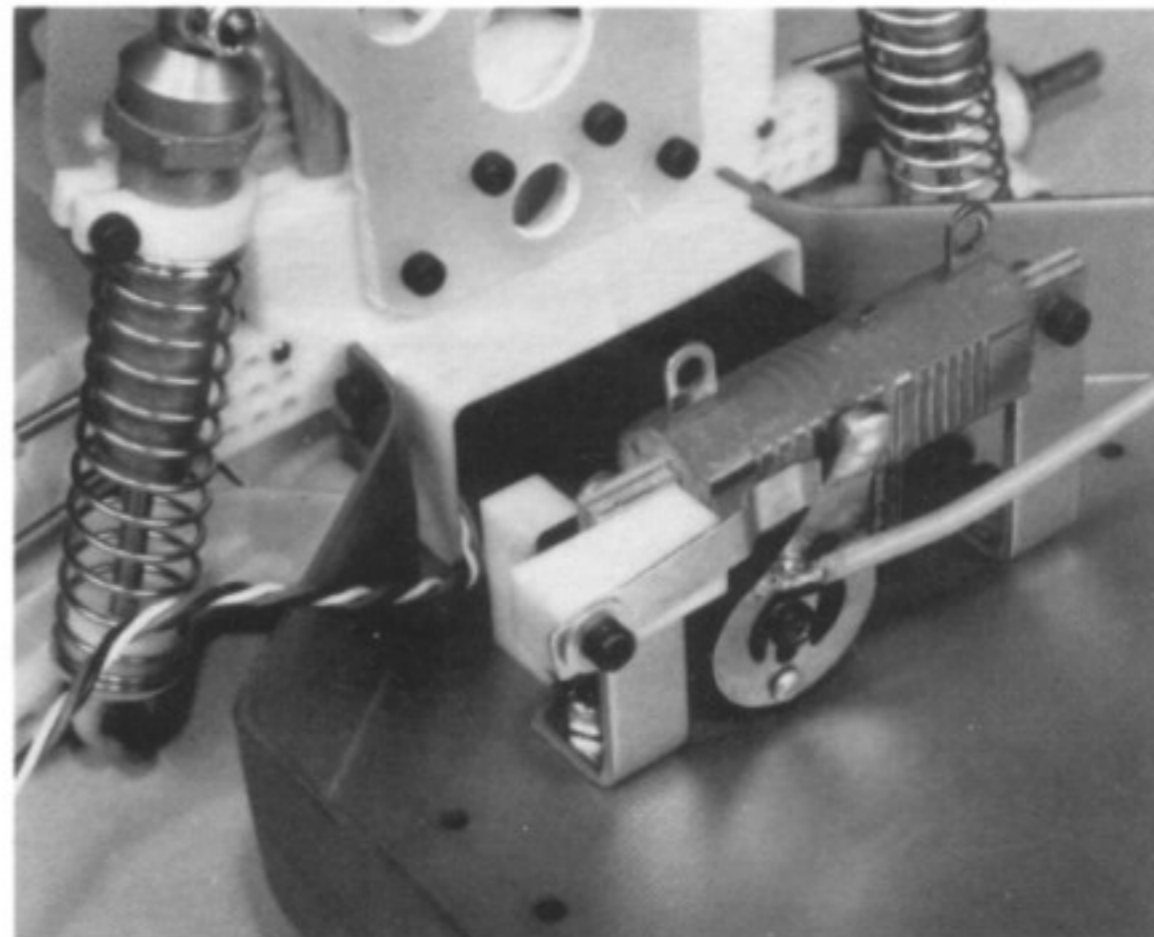

Fig. 161

Fig. 160 Follow the first part of step 155 to determine the mounting position for the wiper. Then remove the servo from the chassis and mount the wiper as shown. Re-install the servo to the chassis.

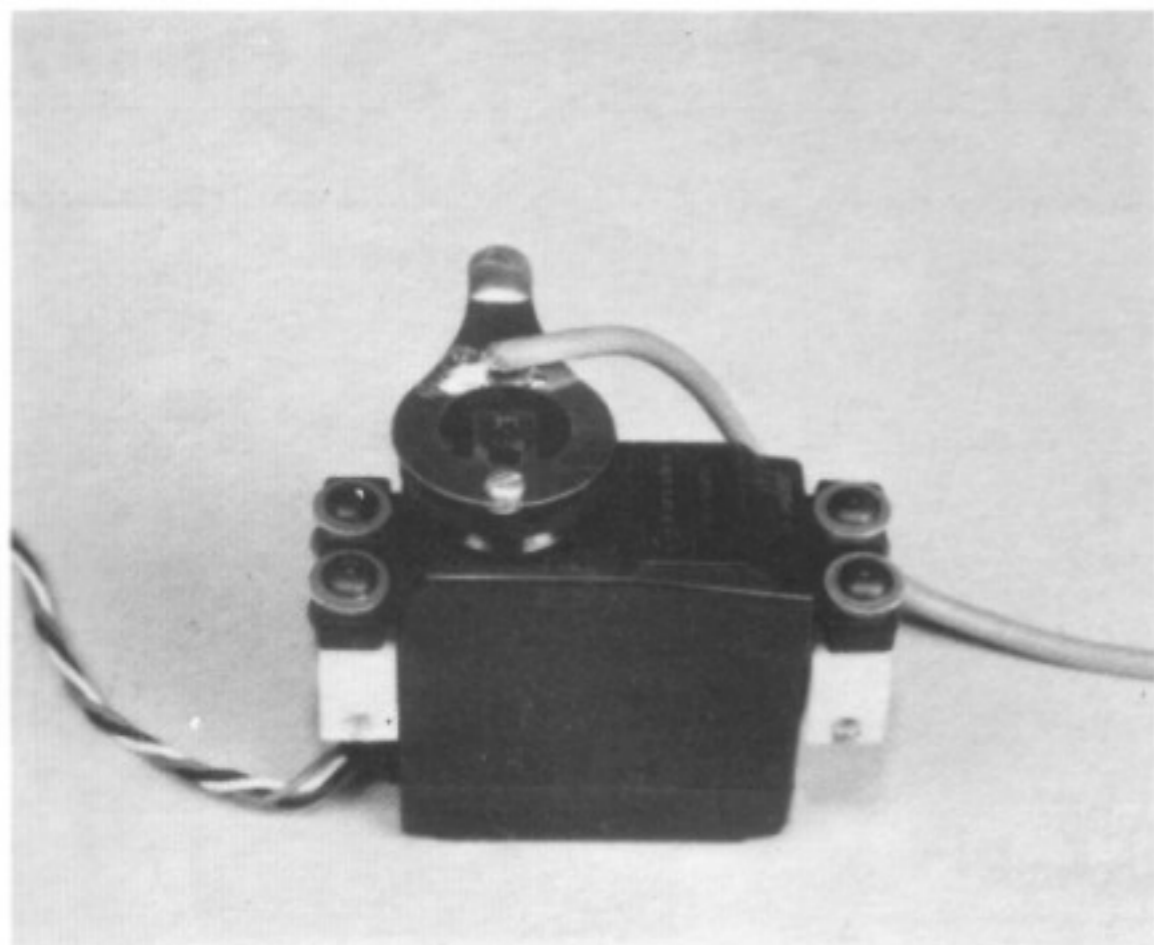

Fig. 160

Special Instructions - Large throttle servo

Fig. 162 It may be necessary to notch the bulkhead to clear the wires for a large servo.

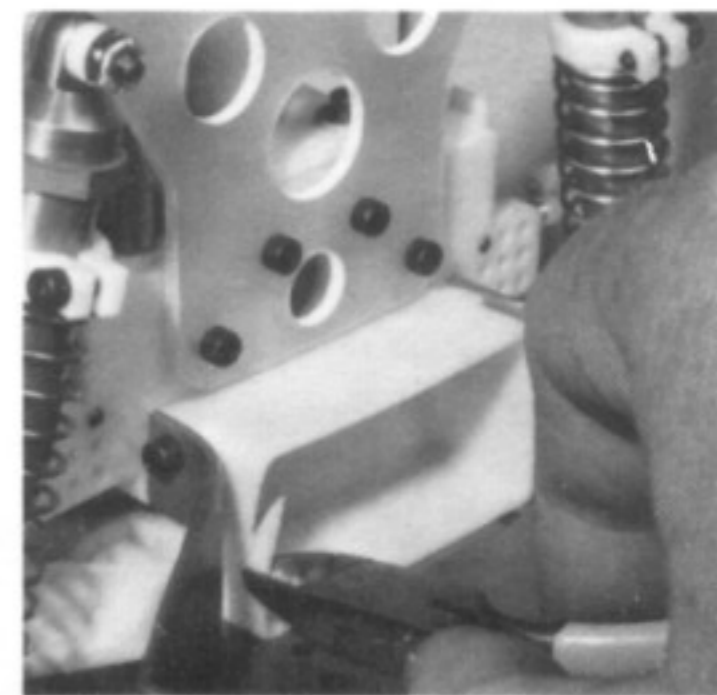

Fig. 162

□ **Fig. 163** This notch is for a Futaba S27 or S29 servo.

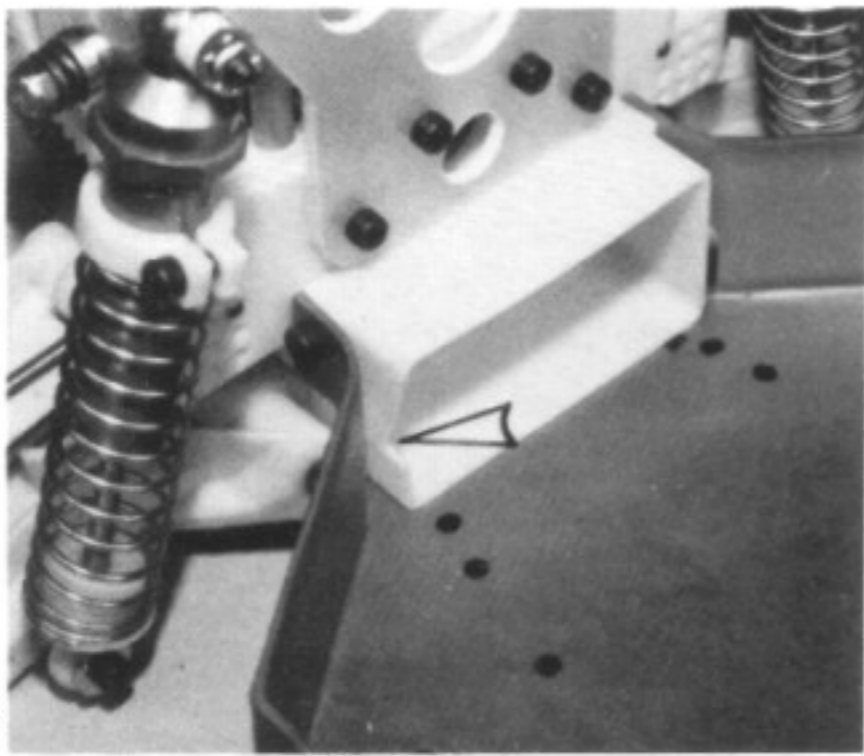

Fig. 163

□ **Fig. 166** Position the servo as far back as possible in the chassis and mark the center and edge of the mounts on both sides with a pencil.

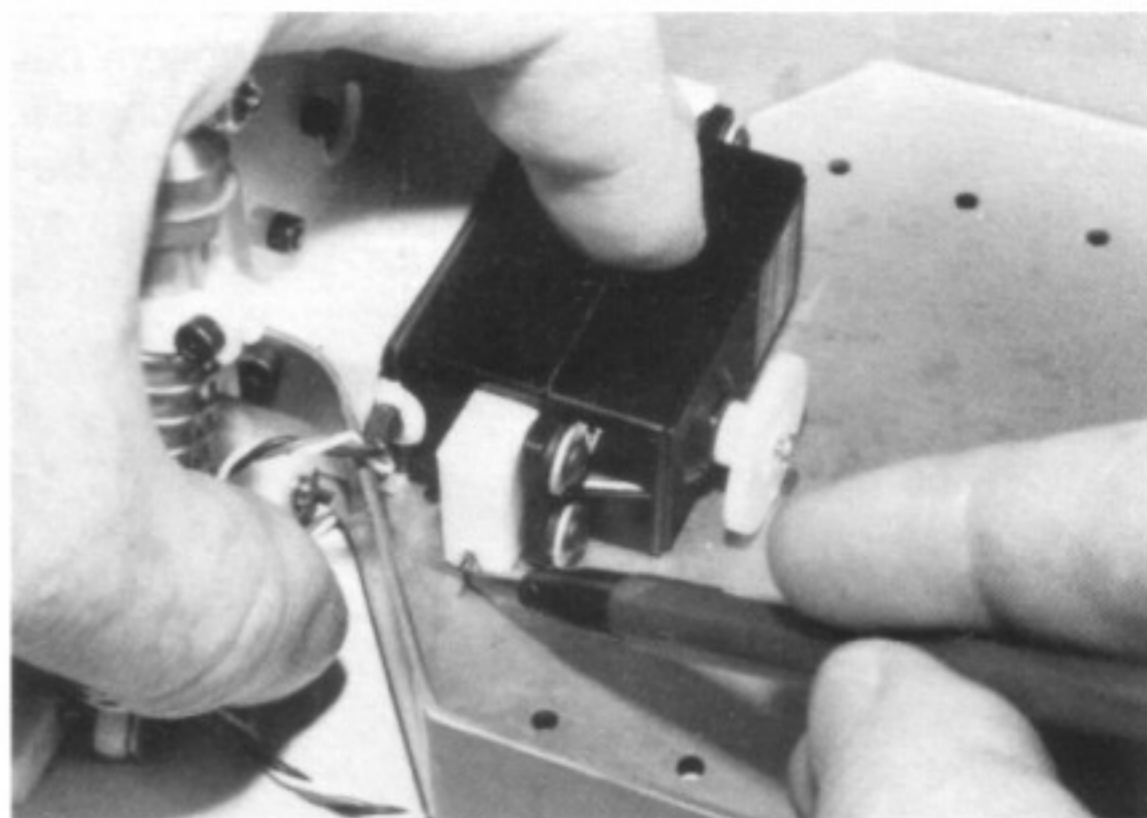

Fig. 166

□ **Fig. 164** Mark the servo mounts for drilling. Note that the mounts are turned the "wide way" on both sides of the servo (see Fig. 165). Position the servo as high as possible on the mounts before marking.

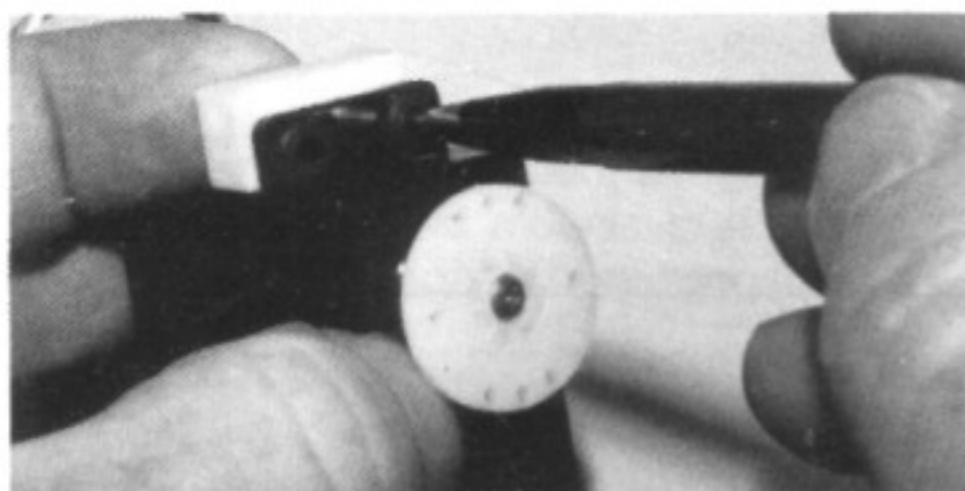

Fig. 164

□ **Fig. 167** Locate the positions for the mounting holes by extending the center lines inward. Center-punch, drill and countersink the chassis as explained in step 148.

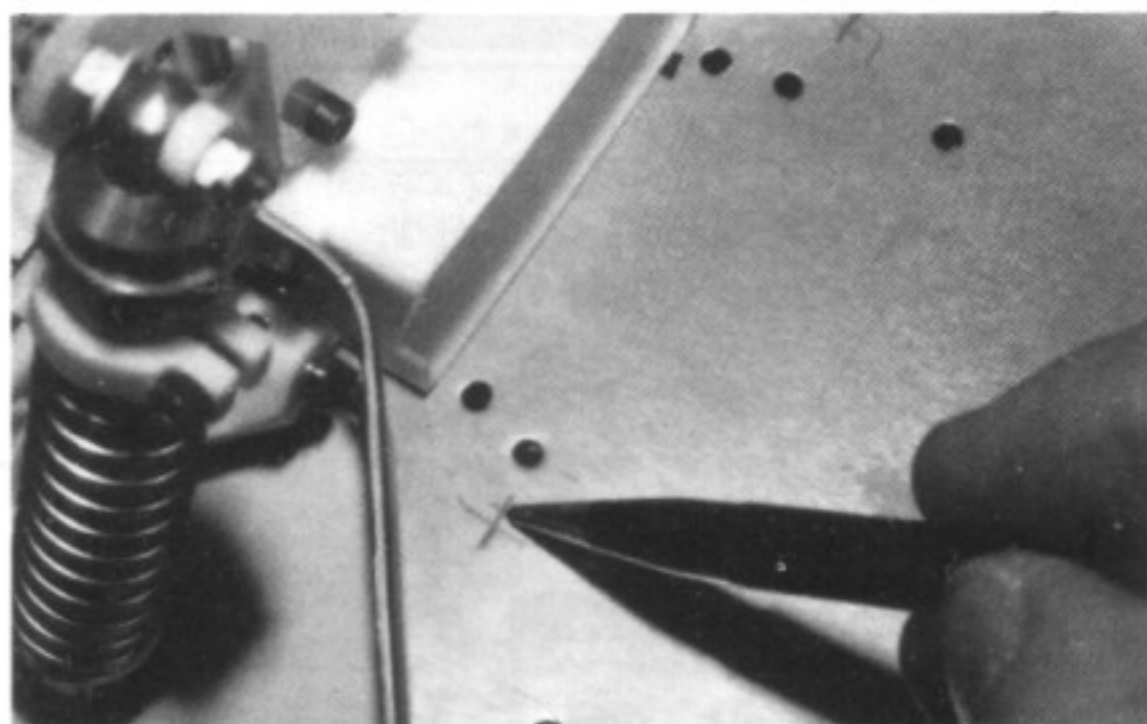

Fig. 167

□ **Fig. 165** S27 servo with mounts installed.

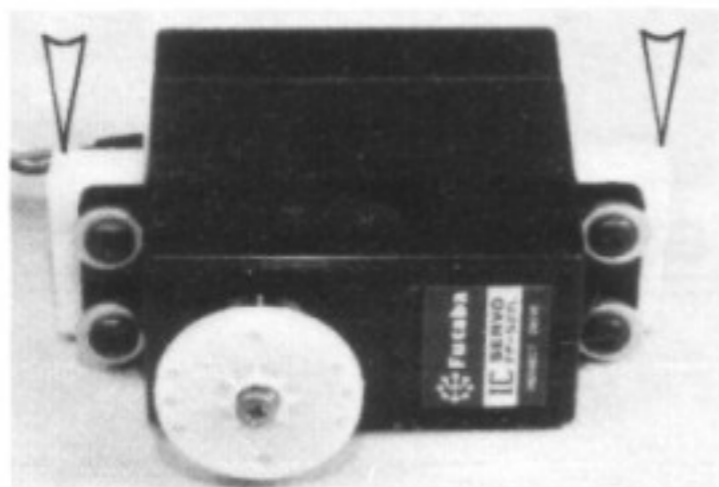

Fig. 165

□ **Fig. 168** Follow the first part of step 155 to determine the mounting position of the wiper. Mount the wiper as shown.

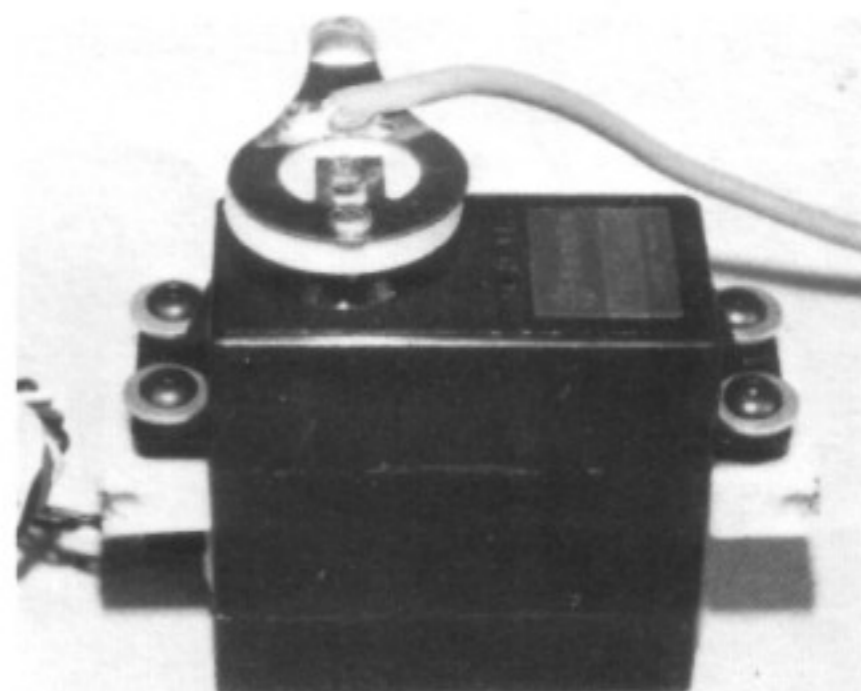

Fig. 168

□ **Fig. 169** Install the servo to the chassis. Mounting holes are typical for S27 servo.

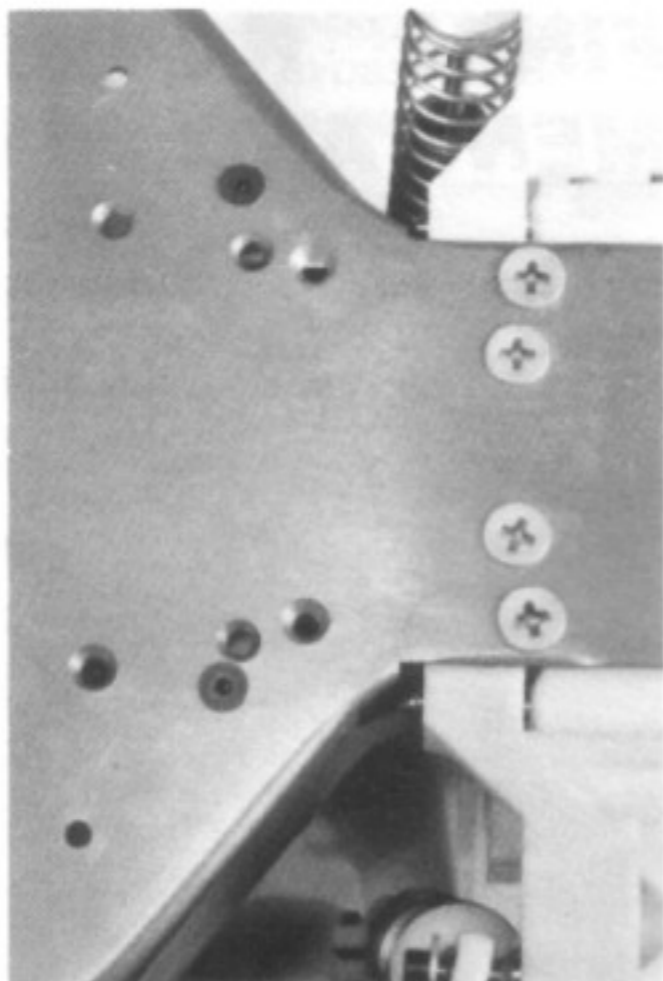

Fig. 169

□ **Fig. 171** Follow steps 152 and 153 to install the throttle resistor, but make the following exceptions: the resistor brackets should be turned 180 degrees, so that they look like fig 171. Mount the resistor BEHIND the brackets instead of in front; and use the thin bypass mount (with the rounded edges). When assembled check for proper wiper pressure as in step 155 and complete with wiring in step 154.

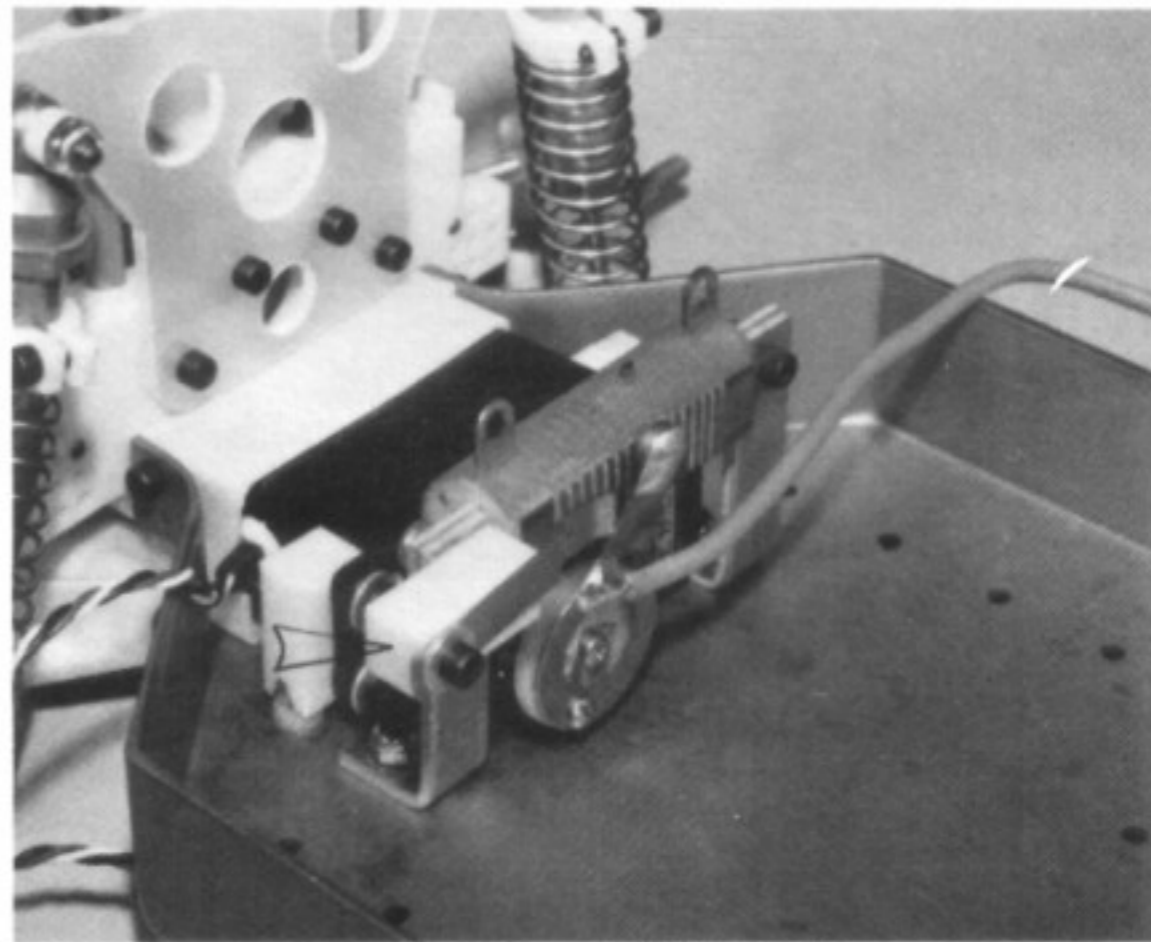

Fig. 171

□ **Fig. 170** S27 servo installed. Use spacers under the mounts to make sure the servo wheel and wiper clear the chassis by about 1/8" (3.1mm).

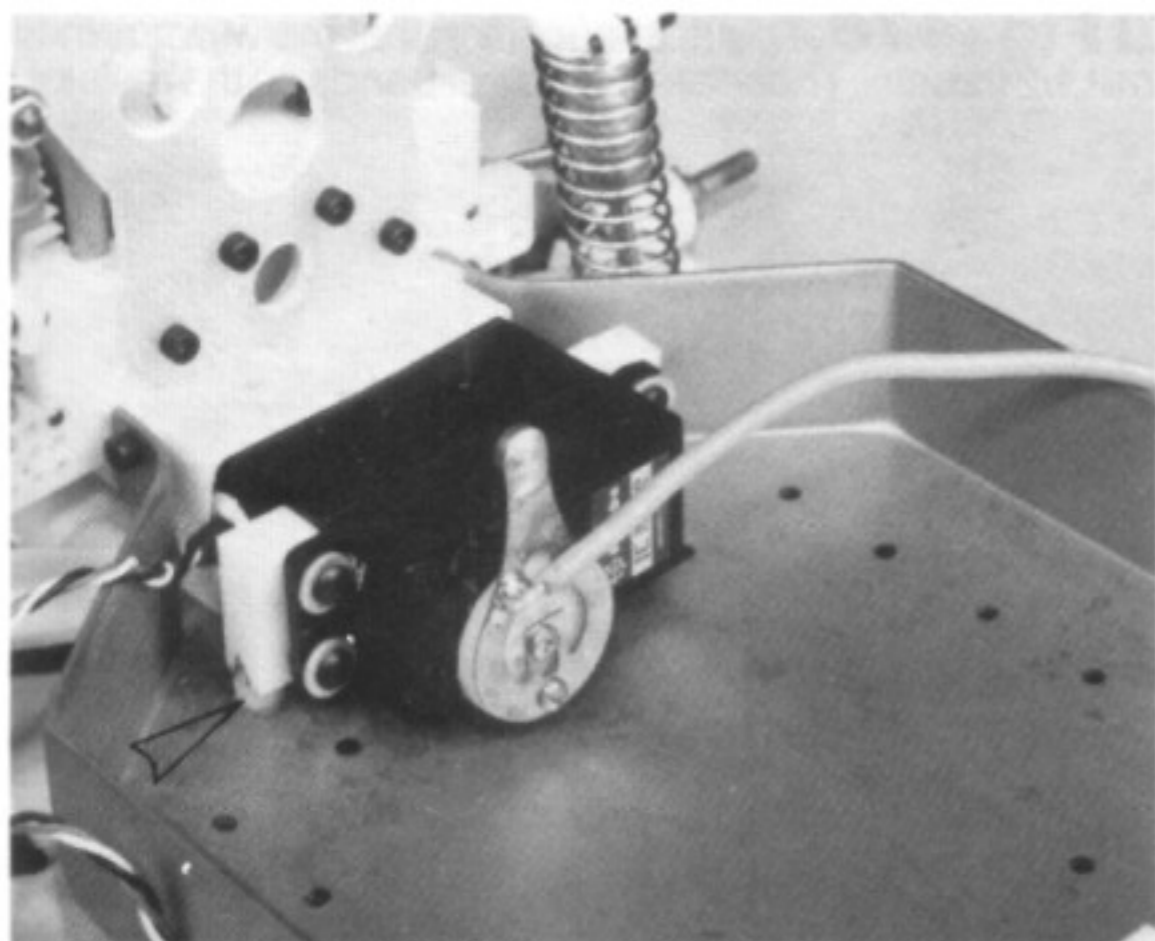

Fig. 170

□ **Fig. 172** Large (S27) servo installed.

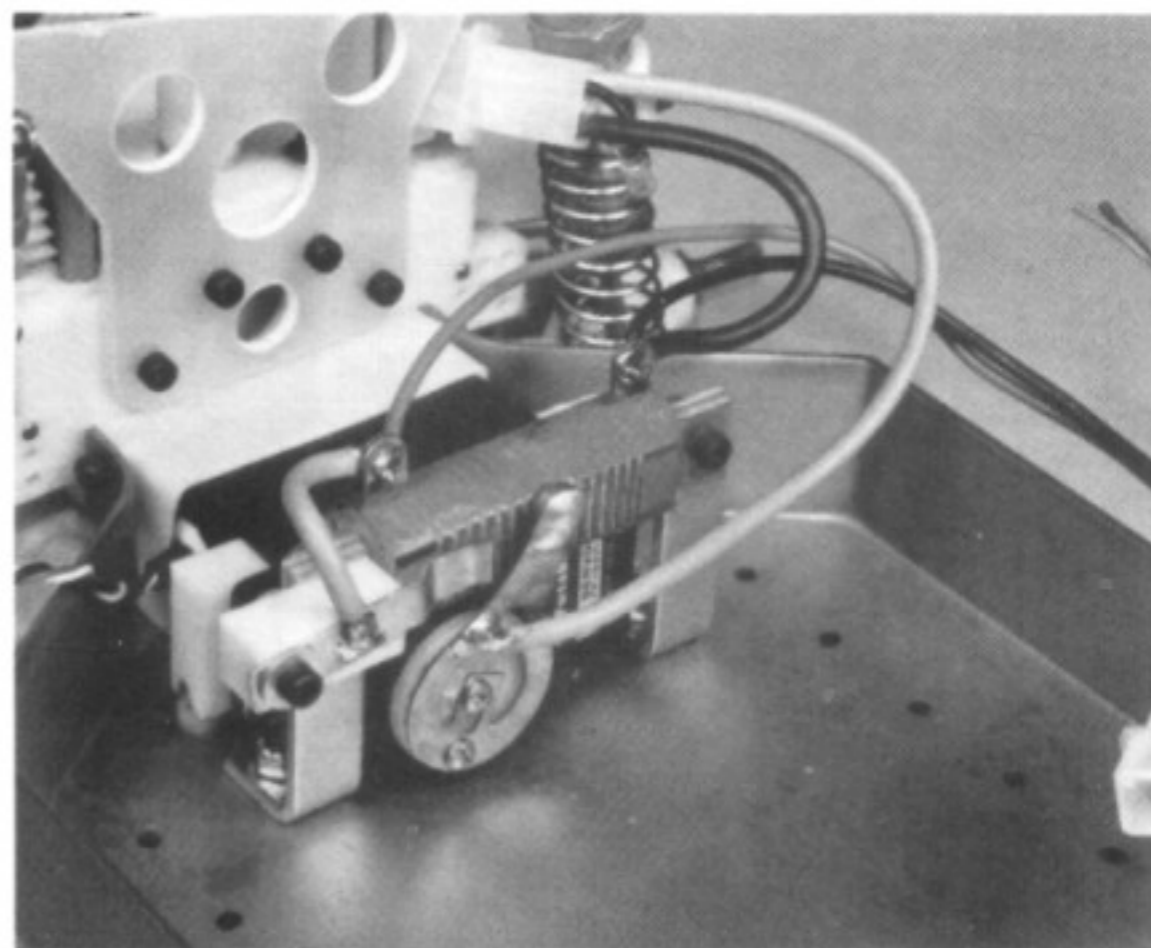

Fig. 172

□ **Fig. 173** Medium (S28) servo installed.

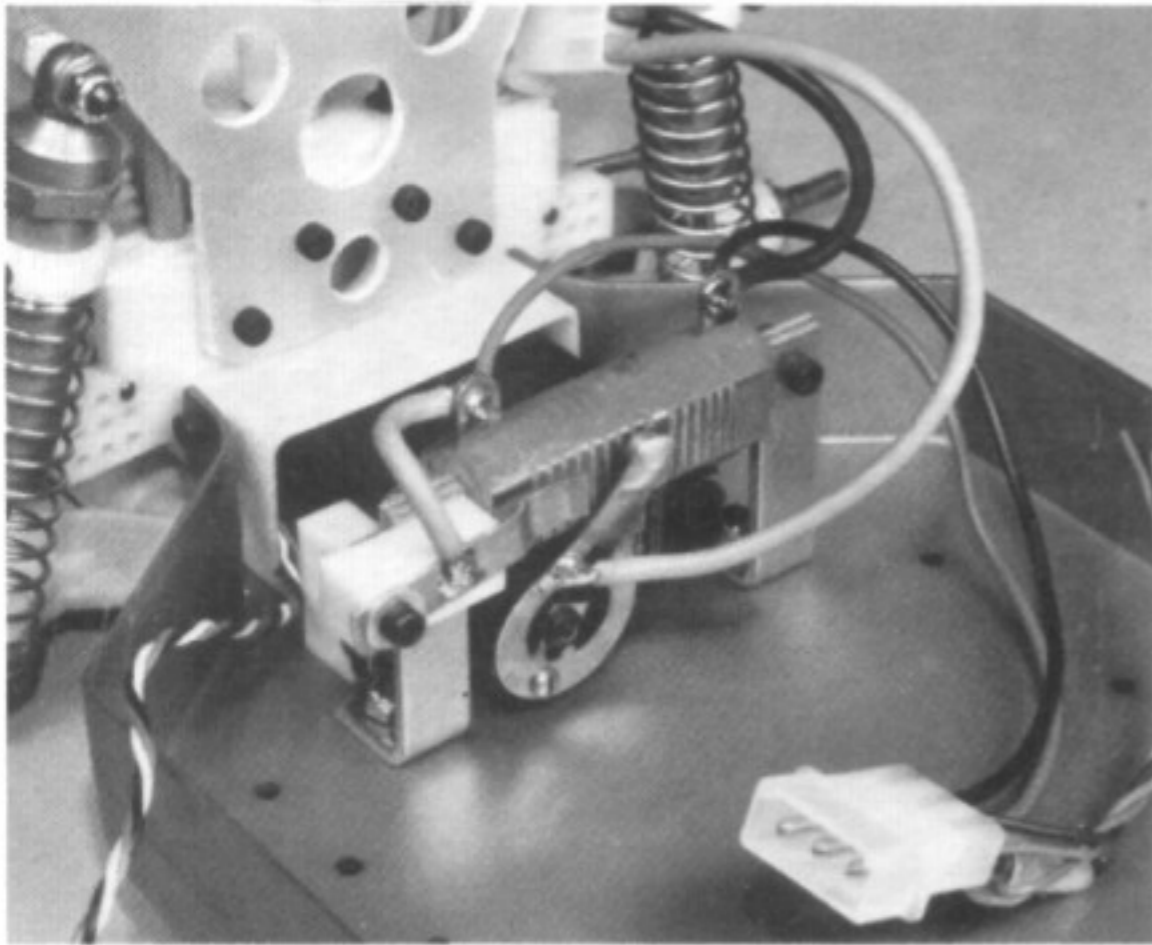

Fig. 173

FINAL RADIO ADJUSTMENT AND WIRING

□ **Fig. 175** Take the bypass and install it to the bypass mount with a 1/2" long Allen screw and washer as shown. Locate the indented portion of the bypass right in the center of the wide bank of the resistor. Solder the bypass wire from the resistor to the arm. This photo shows where the wiper arm should be in the off throttle or brake position. On this side of the resistor are the brake bands.

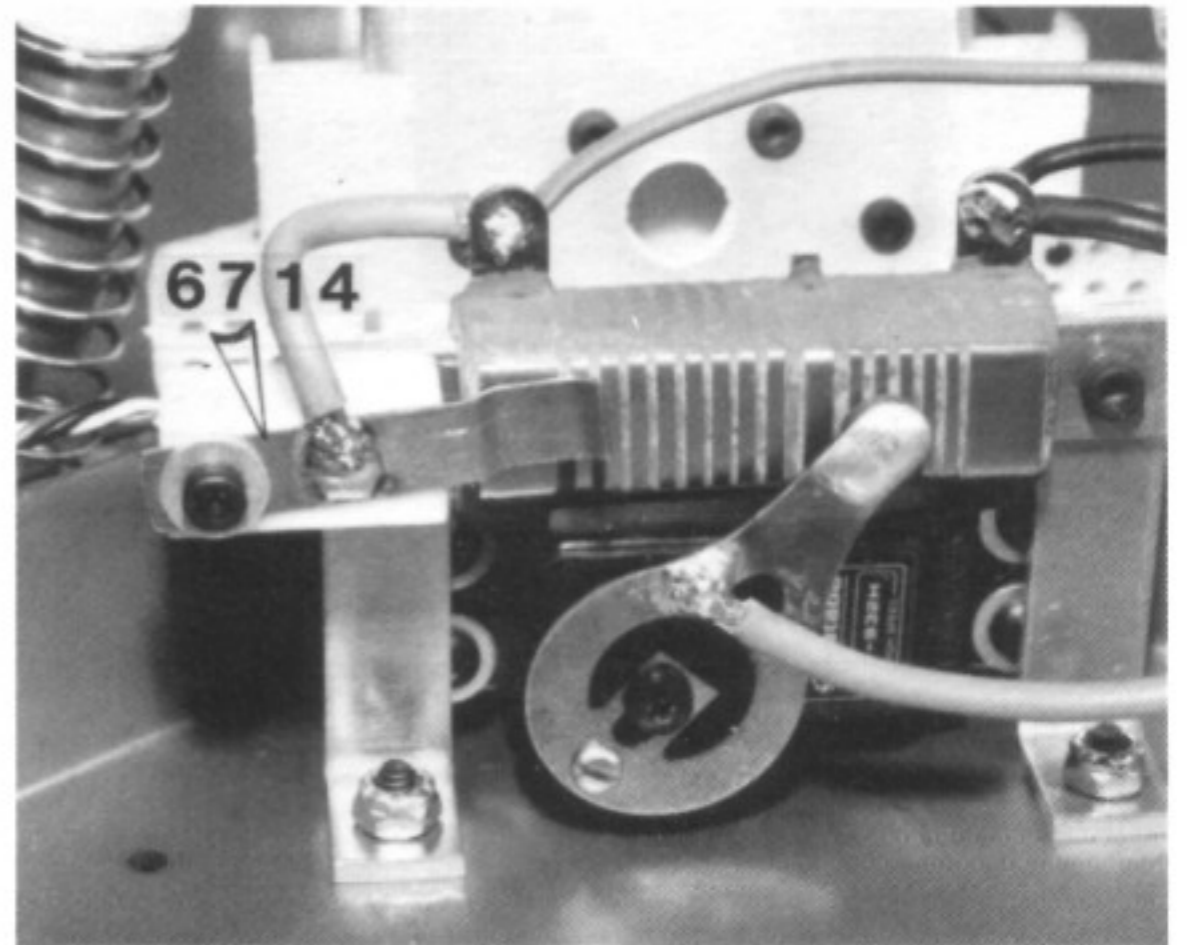

Fig. 175

□ **Fig. 174** Small (S32) servo installed.

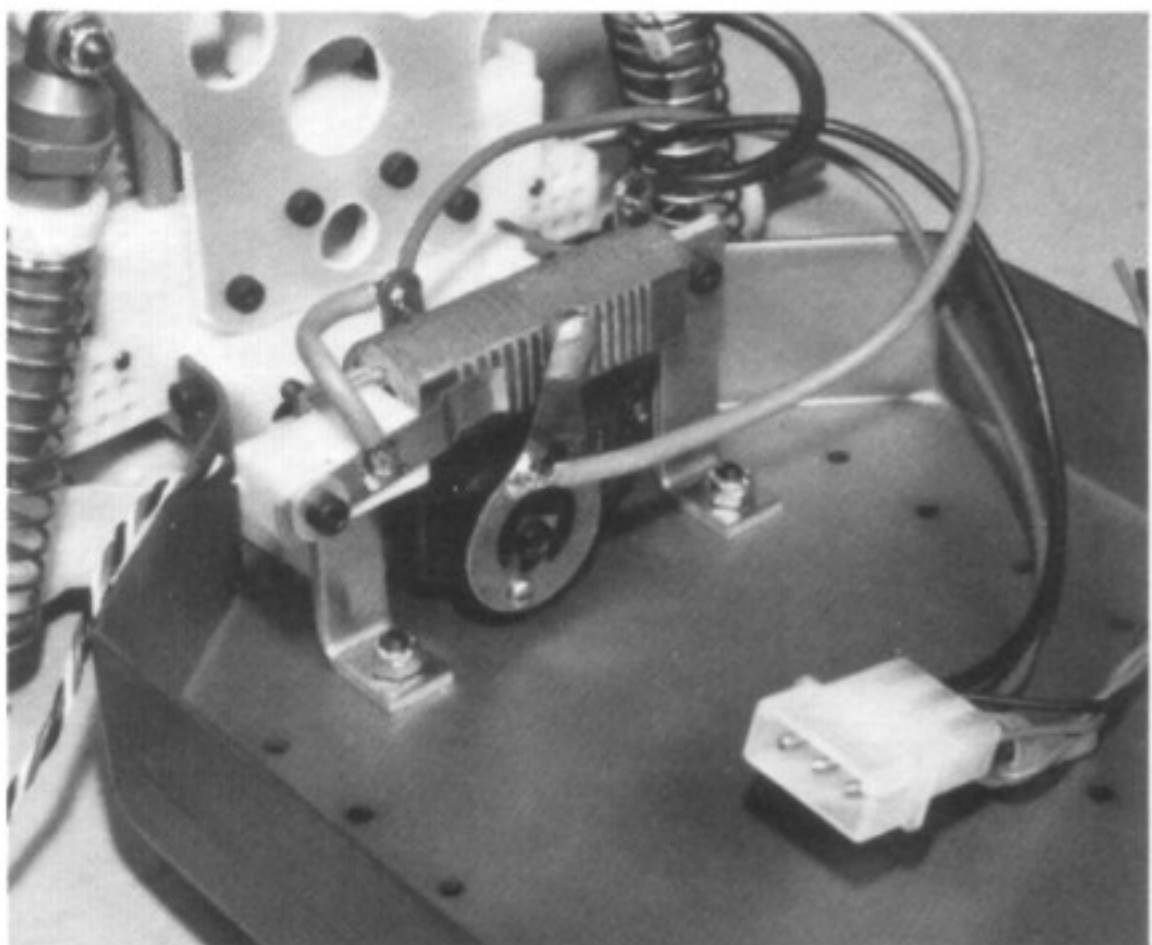

Fig. 174

□ **Fig. 176** This is the position that the wiper arm is in at 1/2 throttle. These are the power bands on the resistor.

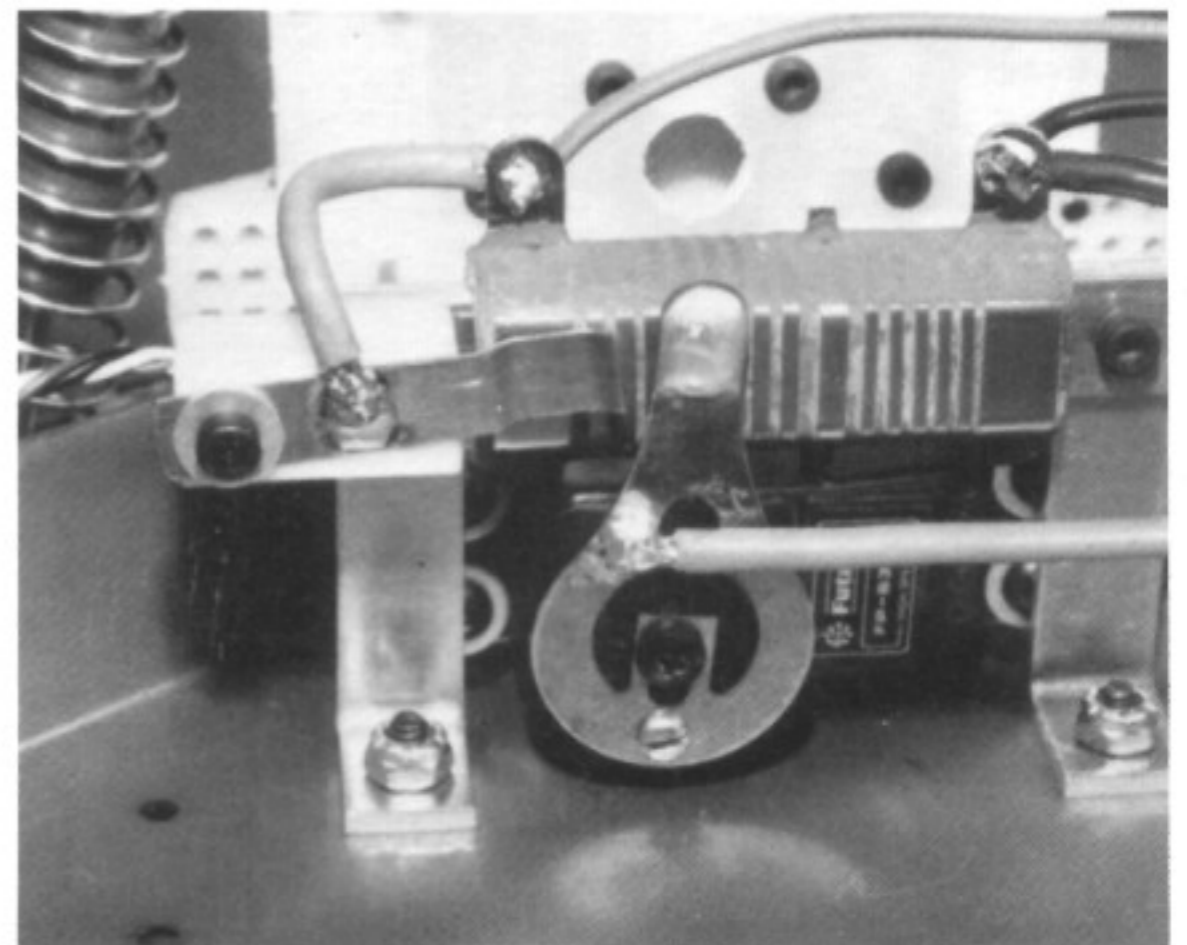

Fig. 176

□ **Fig. 177** This is the full power position of the wiper arm. It should be directly behind the bypass button and in the center of the wide band on the resistor.

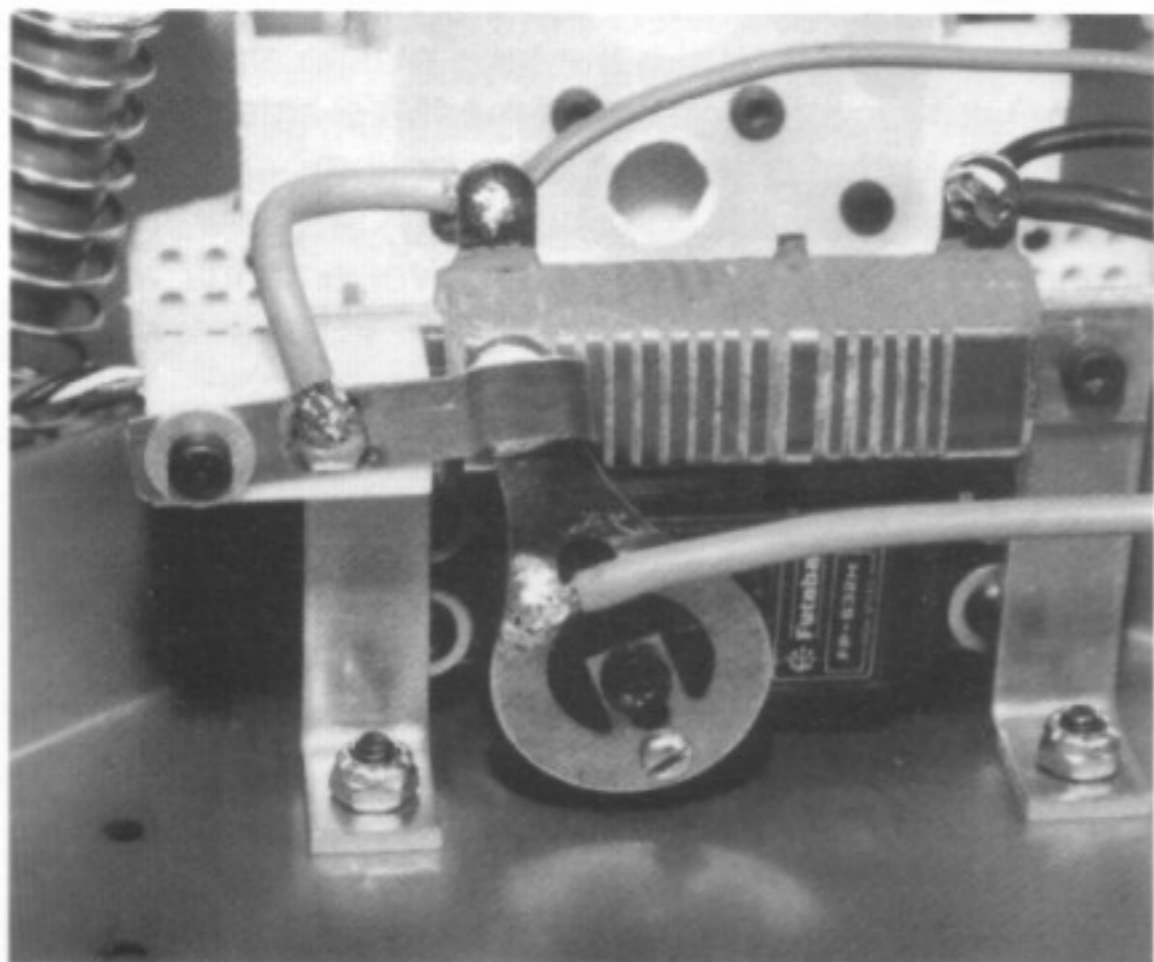

Fig. 177

□ **Fig. 178** The arrow is pointing to the space between the bypass button and the resistor band. This distance should be about .025 (.65mm) less than the thickness of the wiper button section, so that when the wiper arm button moves to full throttle it makes the bypass arm move about .025 (.65mm) forward. This bypass arm then helps to increase the pressure on the throttle wiper arm button, thereby giving it an excellent electrical connection. This, of course, allows the motor to achieve full horsepower and helps the resistor to last longer.

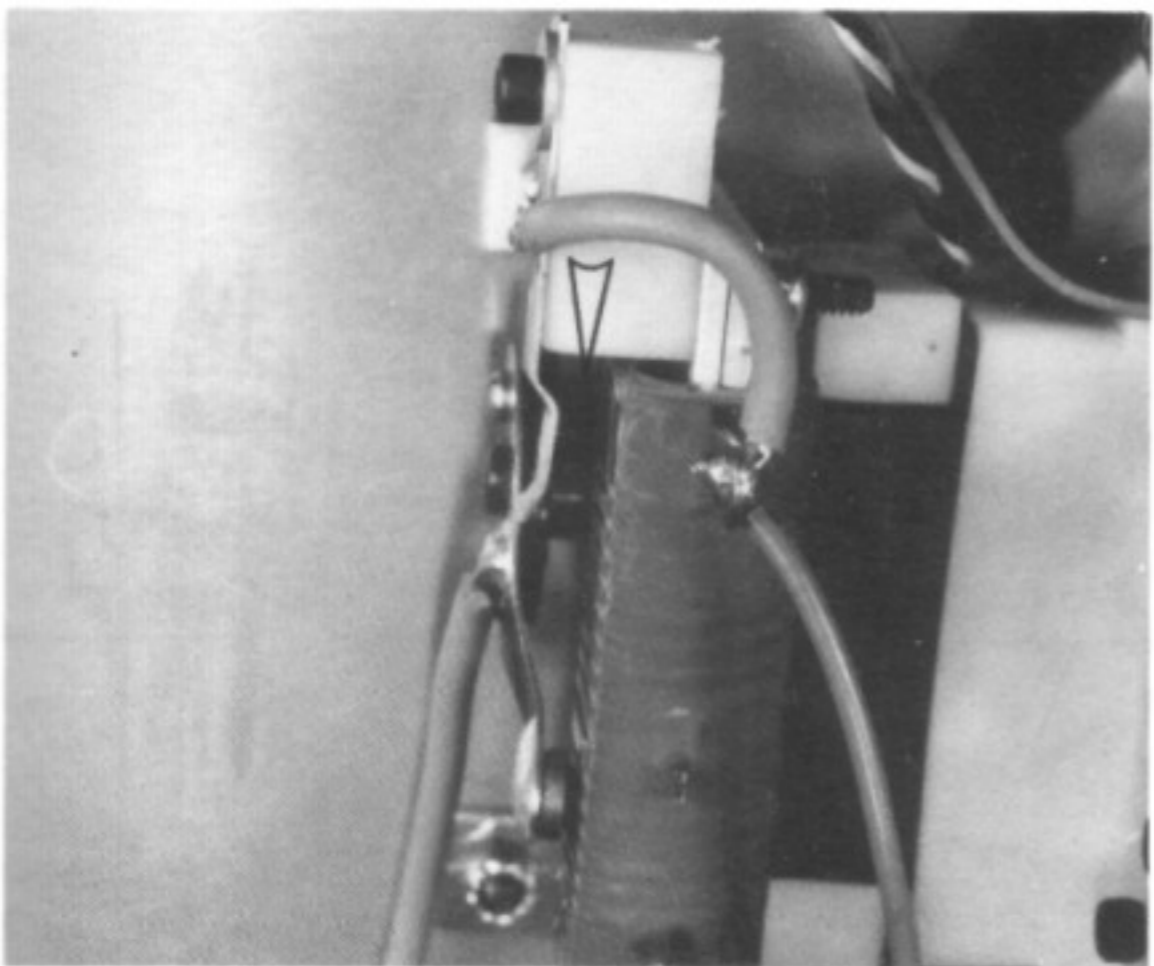

Fig. 178

□ **Fig. 179** We've installed the #6745 portion of the wiring, now we'll finish the #6744 wiring. Now, we'll attach the wires to the switch. On the wiring diagram fig. 208 it shows a black, a green and a red wire going to the radio. You'll only use 2 of these wires, not all 3. On the wiring diagram, you'll notice there are diodes by the battery plug. These diodes cut the voltage down going to your radio so you won't burn out your radio. We'll be attaching 2 of these wires to 2 wires on the radio switch. If there's short wires on the switch, use these for the connections. You'll have to cut the connector off and strip the end of the wires about 1/4" for soldering. We'll tell you the correct wiring for different radio and battery combinations. With a Futaba radio and a 6 cell battery pack - solder the black (-) lead, on the diagram, to the black (-) lead, on the switch. Then solder the green (+) lead on the diagram to the red (+) lead on the switch. Cut the extra red wire off by the 3 pin connector. With a Futaba radio and a 7 cell battery pack, solder the 2 black ends together, and then solder the 2 red ends together. Cut the green wire off by the diode. With an Airtronics radio and a 6 cell battery pack solder the black (-) lead, on the diagram, to the #2(-) which is marked on the switch plug. Now solder the green (+) lead on the diagram to the #3(+) lead. Cut the extra red wire off by the 3 pin connector. With an Airtronics radio a 7 cell pack - solder the black (-) lead, on the diagram, to the #2(-) wire. Now solder the red (+) lead to the #3(+) wire. Cut the extra green wire off by the diode. For other radios you'll always solder the black (-) wire to the (-) wire on your switch. With a 6 cell battery pack you'll solder the green (+) wire to the (+) wire on your switch and with a 7 cell pack you'll solder the red (+) wire to the (+) wire on your switch. Now, with black electrical tape, put a few wraps of tape around the first solder connection, and then put a few wraps around the 2nd solder connection. Now, attach the #6334 battery trays to the chassis, from Bag #6-7, as shown, with the flathead Allen screws.

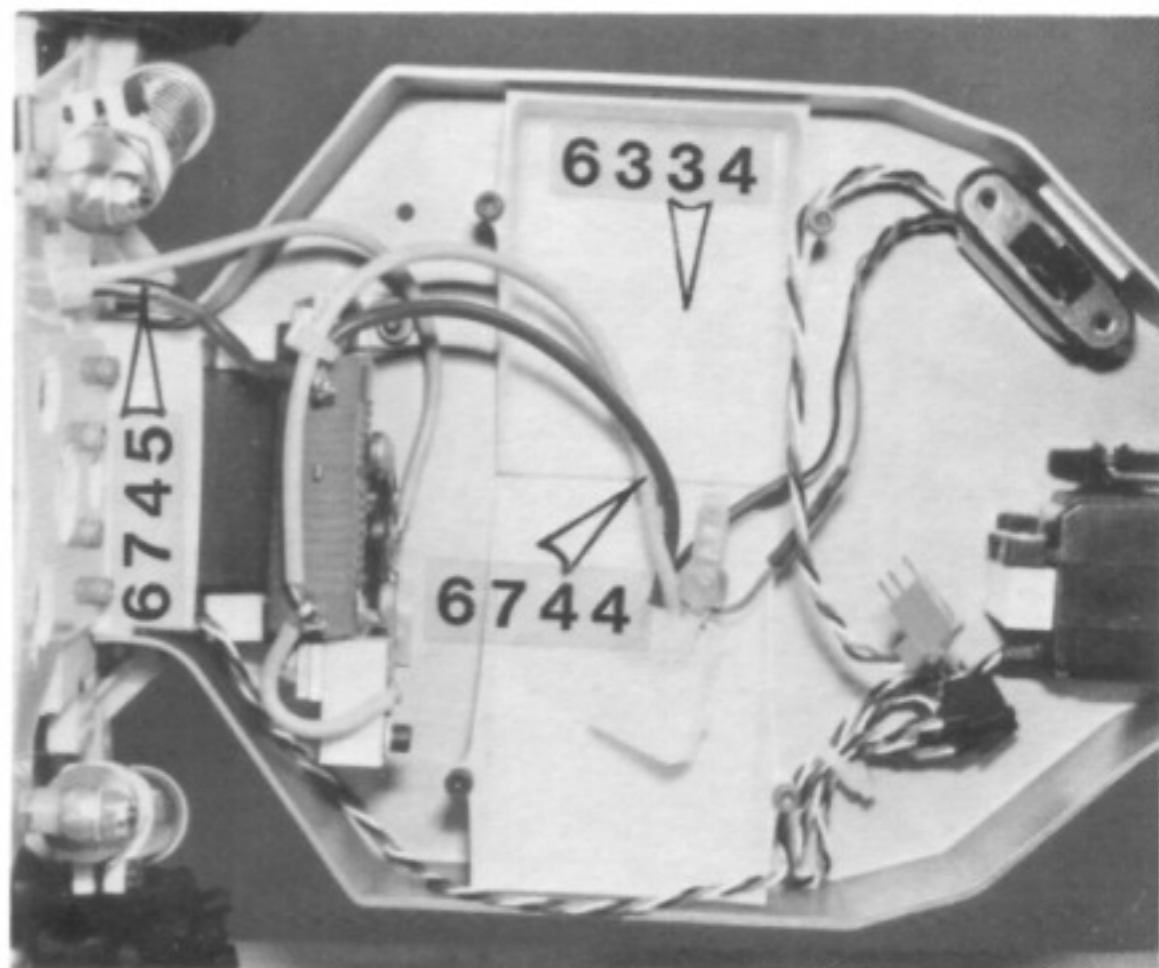

Fig. 179

□ **Fig. 180** In Bag #6-7 are 2 Allen screws with cross drilled holes in the heads. Install these in the 2 forward holes in the battery trays, where the arrow is pointing. Do not tighten the screws all the way down, but leave them up about .025 (65mm). Then in the other 2 rear holes install the other 2 regular Allen screws. Do not tighten these all the way either, but leave them up about .080 (2mm). Now, attach the switch to the side of the chassis, as shown, with servo tape. Mount the switch down low so the toggle doesn't hit the body.

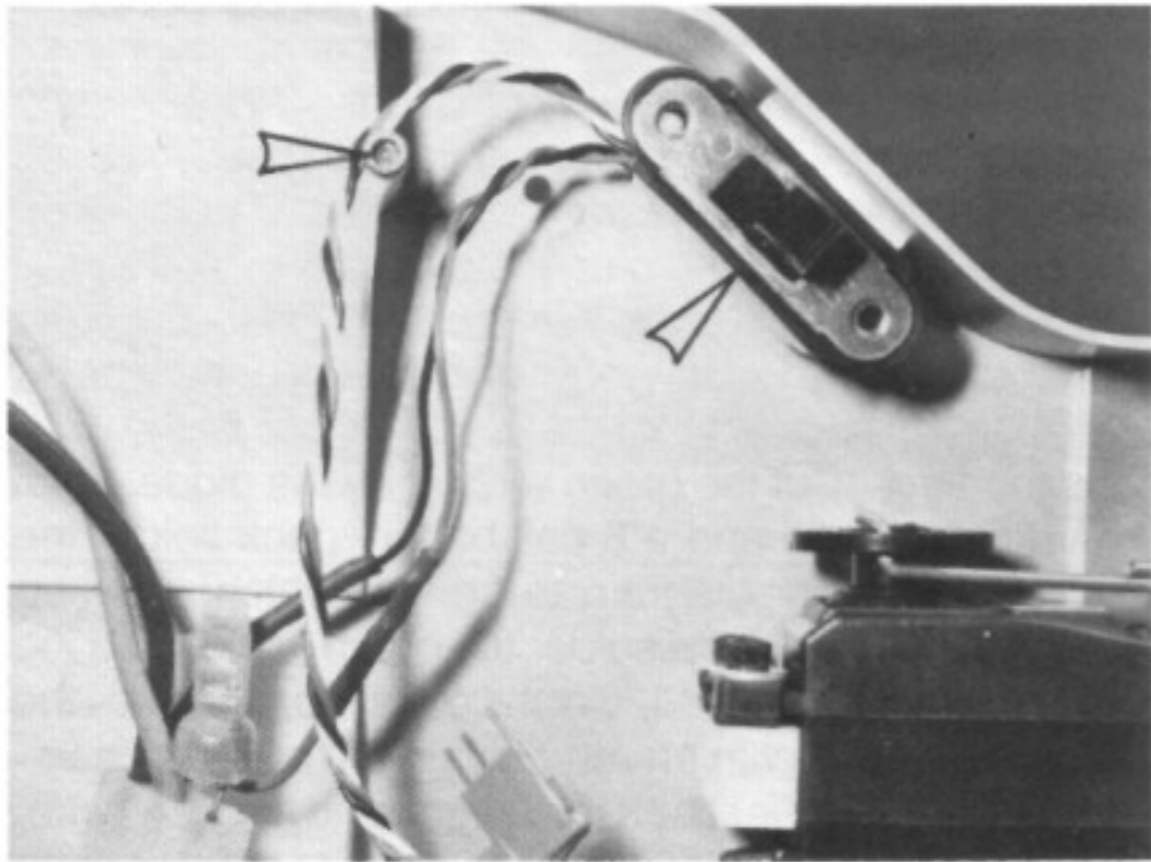

Fig. 180

□ **Fig. 181** There should be enough room to mount the receiver between the servo and battery trays, as shown. Put about 4 layers of servo tape on the bottom of the receiver and stick it to the chassis. If you have a bigger servo or receiver, stand the receiver on its side and mount it.

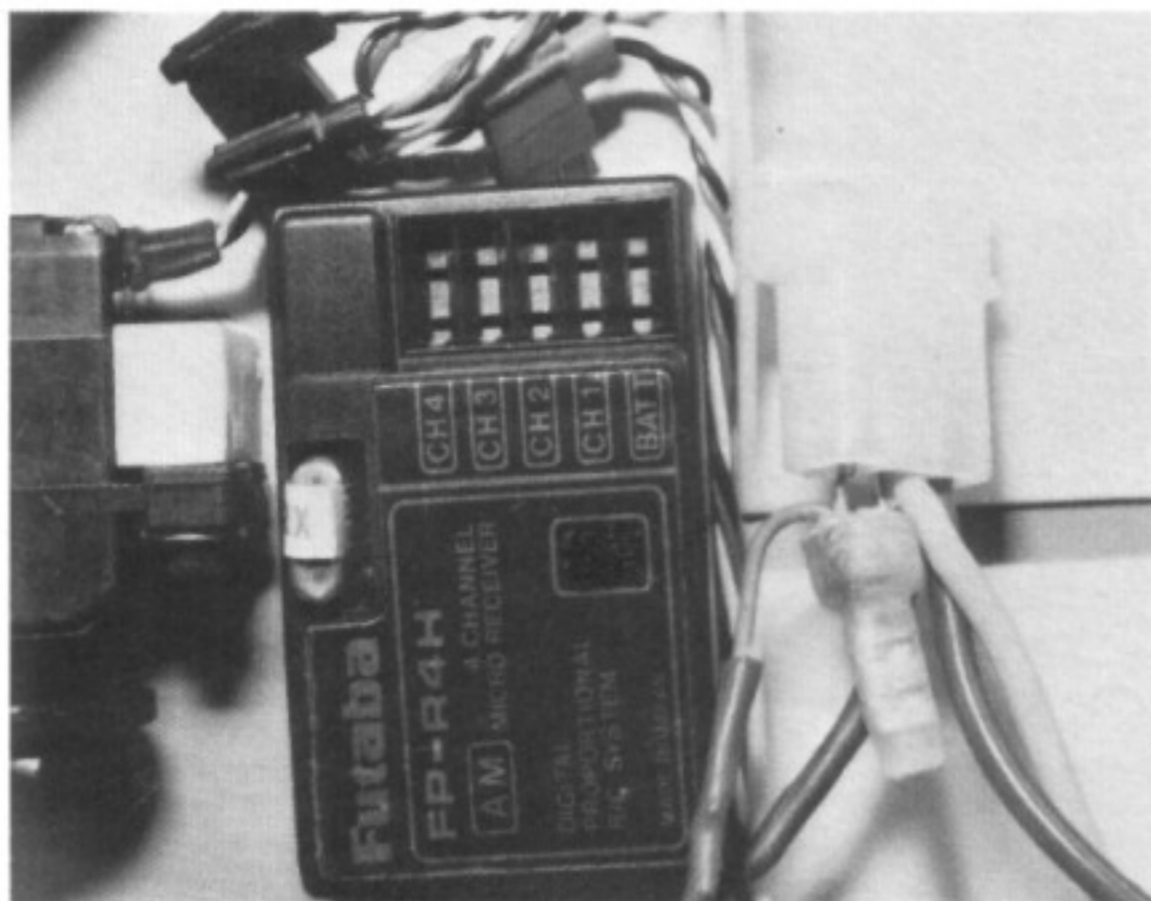

Fig. 181

□ **Fig. 182** Install the wire plug from the switch into the battery socket in your receiver. Install the steering servo plug into the proper socket and then install the throttle servo plug into the proper socket per your radios instruction manual. Take the long plastic antenna tube and install it into the large hole in the #6338 antenna mount. The round end of the mount is the bottom.

The tube will fit tight, but it will go in. Now, from the bottom of the tube, feed the receiver antenna wire up through the tube, from the bottom. Push the wire up through the top about 1" (25mm) and tie a knot in it. Now attach the antenna mount in the location shown. Any excess antenna wire can be stowed by the mount, as shown. There are a few extra holes in the bottom of the chassis which will not be used. Cover these holes, from the top, with cellophane tape or the servo tape and this will help to keep the dirt out of the car.

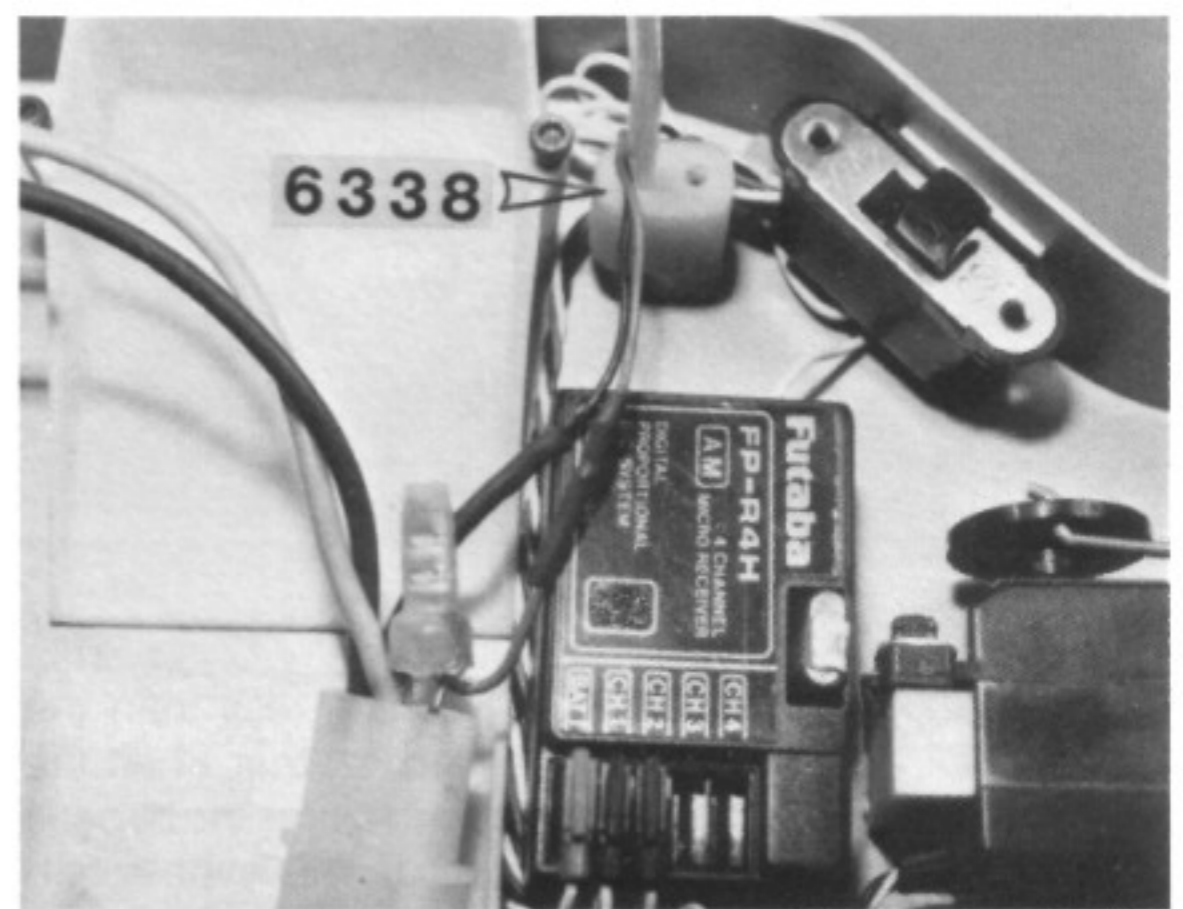

Fig. 182

□ **Fig. 183** Now we'll assemble the batteries. You'll notice there should be one positive and one negative end on each end of the battery pack. There is also a battery assembly drawing page in the back of these instructions. Attach the 2 battery sticks together with servo tape, as the photo shows so the tabs can be soldered together. If the tabs are too short, connect them with a piece of wire and rosin core solder together, as shown.

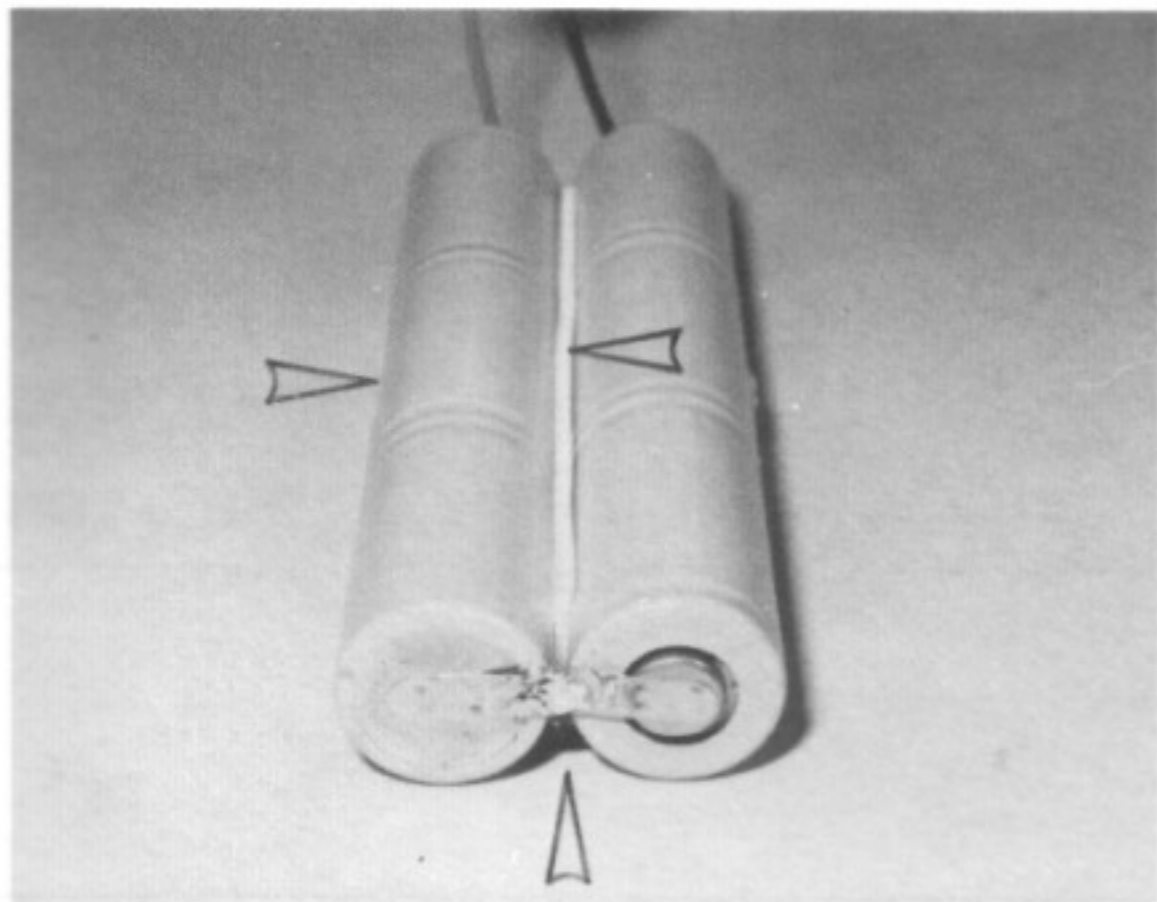

Fig. 183

□ **Fig. 184** In this photo, the arrow is pointing to the negative side. Solder the black wire to this tab, as shown.

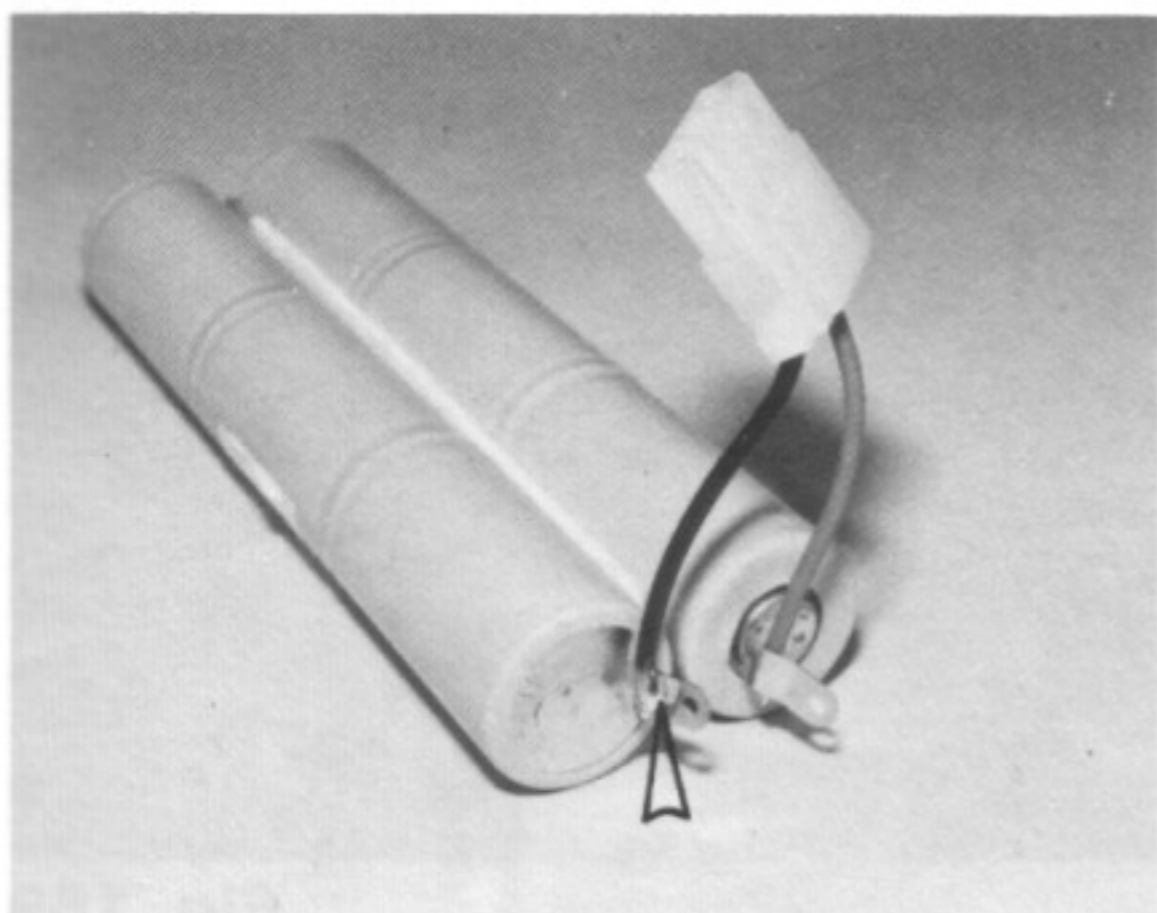

Fig. 184

□ **Fig. 185** In this photo, the arrow is pointing to the positive end. Solder the red wire to this tab and then bend the tabs back flush as close as possible.

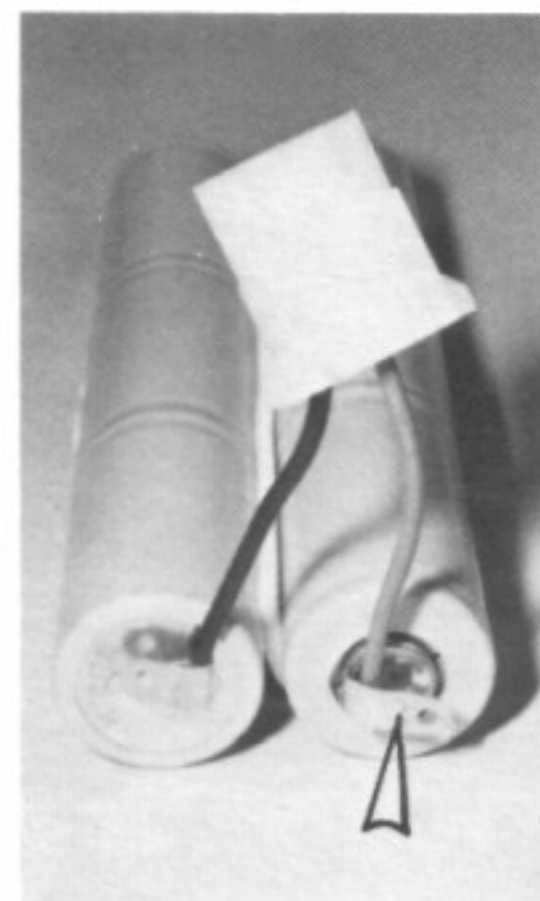

Fig. 185

□ **Fig. 186** Now wrap both ends of the battery with strapping tape or black electrical tape, as shown.

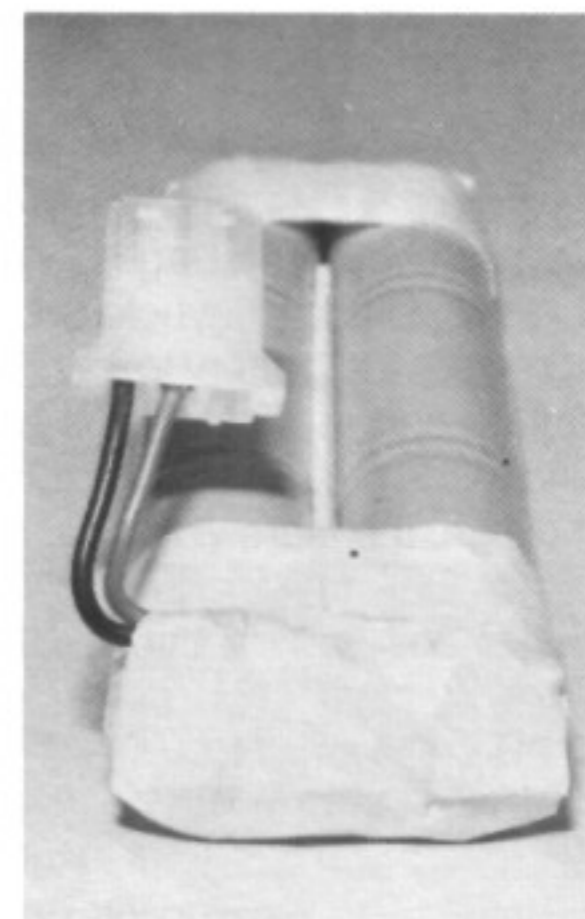

Fig. 186

□ **Fig. 187** In Bag #8-6 is the #3736 battery charge cord. We'll have to solder the ends to the wires. The arrows, in the photo, are pointing to the positive (+) connection. This is the silver appearing wire, not the black wire. There is a clear plastic coating on this wire, which is very hard to see. Take your Xacto knife and scrap off this clear coating on the end for soldering. Slip the red tube on the wire. Now solder the wire to the clip as shown. If you have a small soldering iron, you'll have to hold it on awhile longer to heat up the clip. Now solder the black negative (-) wire to the other clip using the black tube. In the back of these instructions is a page on charging batteries. Read it carefully and charge the battery pack. Also make sure the batteries in your radio transmitter are charged.

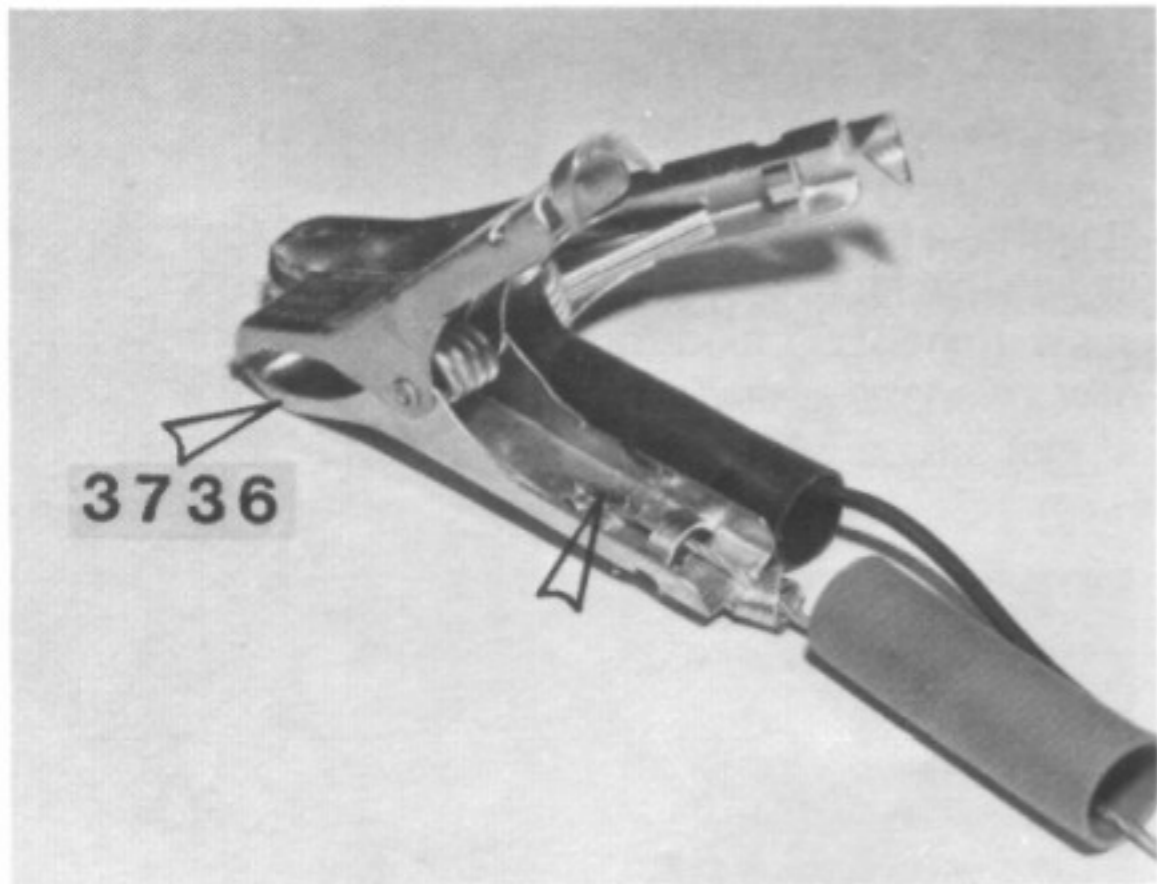

Fig. 187

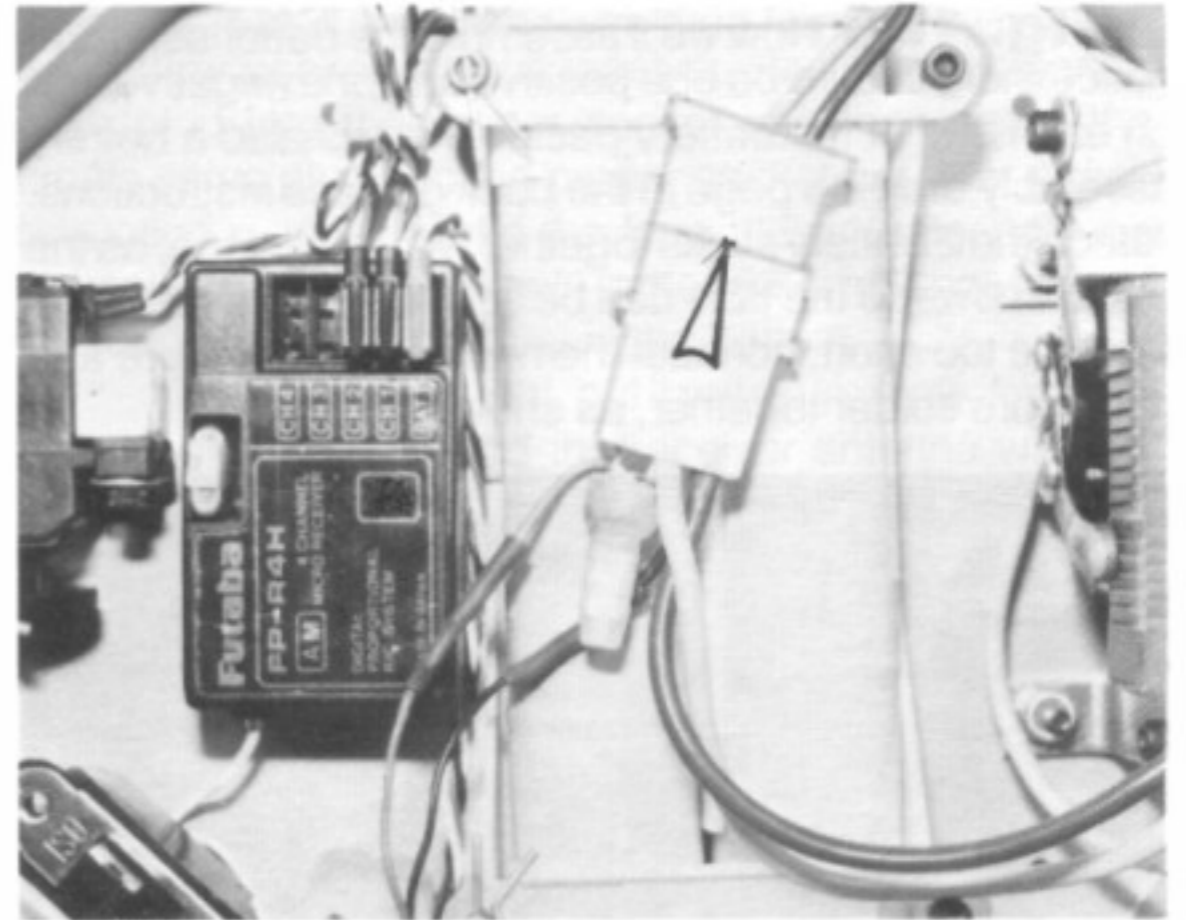

Fig. 188

Fig. 188 Slip the charged batteries into the radio tray, as shown. In Bag #6-7 are the 2 battery straps and 4 clips. Slip the keyhole end of the straps, over the rear screws in the battery trays. Then pull them forward so the slotted end slips under the screw head. Slip the forward end of the straps over the forward screws and put 2 clips through the screw heads. Take your charged radio transmitter, pull the antenna up and turn the transmitter switch on. Plug the battery plug into the wiring plug as the arrow shows. If your servos moved then your switch was in the "ON" position. Make sure your switch is correctly marked "OFF" and "ON". Turn your switch on for ONE SECOND and turn it off. Refer to photo 175. See if your resistor arm is close to this position. If it is not, unscrew the wiper arm off the servo wheel. Turn the switch on. Advance the throttle arm on the transmitter. See if the servo arm rotates in the proper direction. If it doesn't turn the car switch off and transmitter off.

Install the wiper arm on the servo arm in the exact location shown in photo 175. Turn the transmitter on and the car switch on. The wiper arm should now be exactly like in photo 175. Pull the throttle half way. The wiper arm should now be close to photo 176. Pull the throttle all the way open. The wiper arm now should be exactly as shown in photo 177. This can be accomplished by setting the end point adjustment on your transmitter per your radio manual. Now refer to photo 143. Turn your transmitter steering wheel to the right. Your wheels should turn to the right. If not, you'll have to reverse the steering servo, as before. Now you'll want to get the #6256 linkage centered, as shown. You may have to change the hole location on the servo wheel.

Fig. 189 Turn the car switch OFF. Plug the motor plug into the wiring socket, as shown, then tie a small tie wrap around the wiring socket and wing tube. This will keep the wires away from the tires.

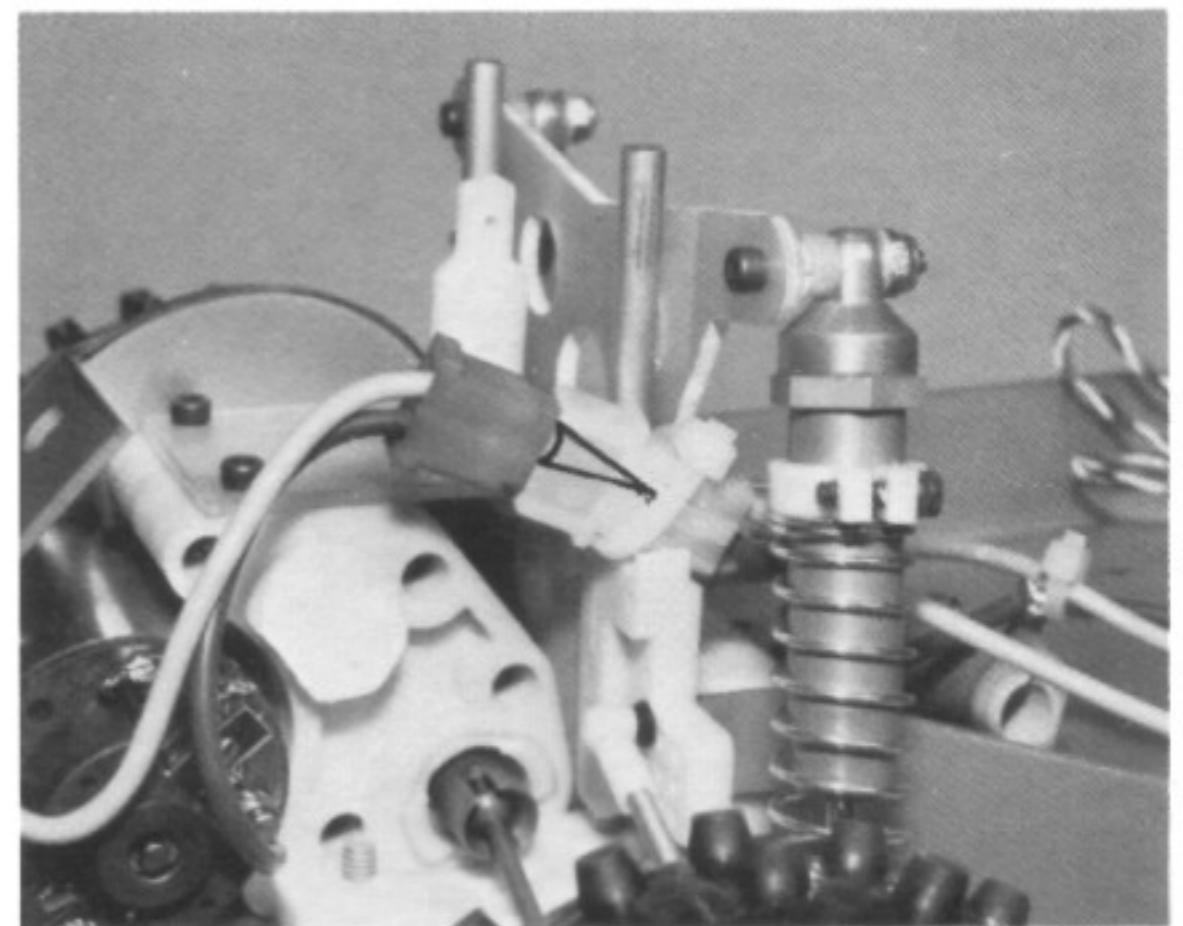

Fig. 189

□ **Fig. 190** Take the front wheels and tires out of the bag. We want to put the large plastic ring inside the tire as shown. Work the ring into the tire until it is seated evenly. Tires vary a lot. Some will go on quite easily, and some will be quite difficult to install. On the tough ones, soapy water, like dish washing soap, will help the rubber to slip easier and will make mounting the tires much easier. Be sure to rinse off the soap and then dry the tires thoroughly.



Fig. 190

□ **Fig. 192** Take the inside half of the front wheel, as shown, and push it into the front tire making sure it is seated all the way around, and centered perfectly.

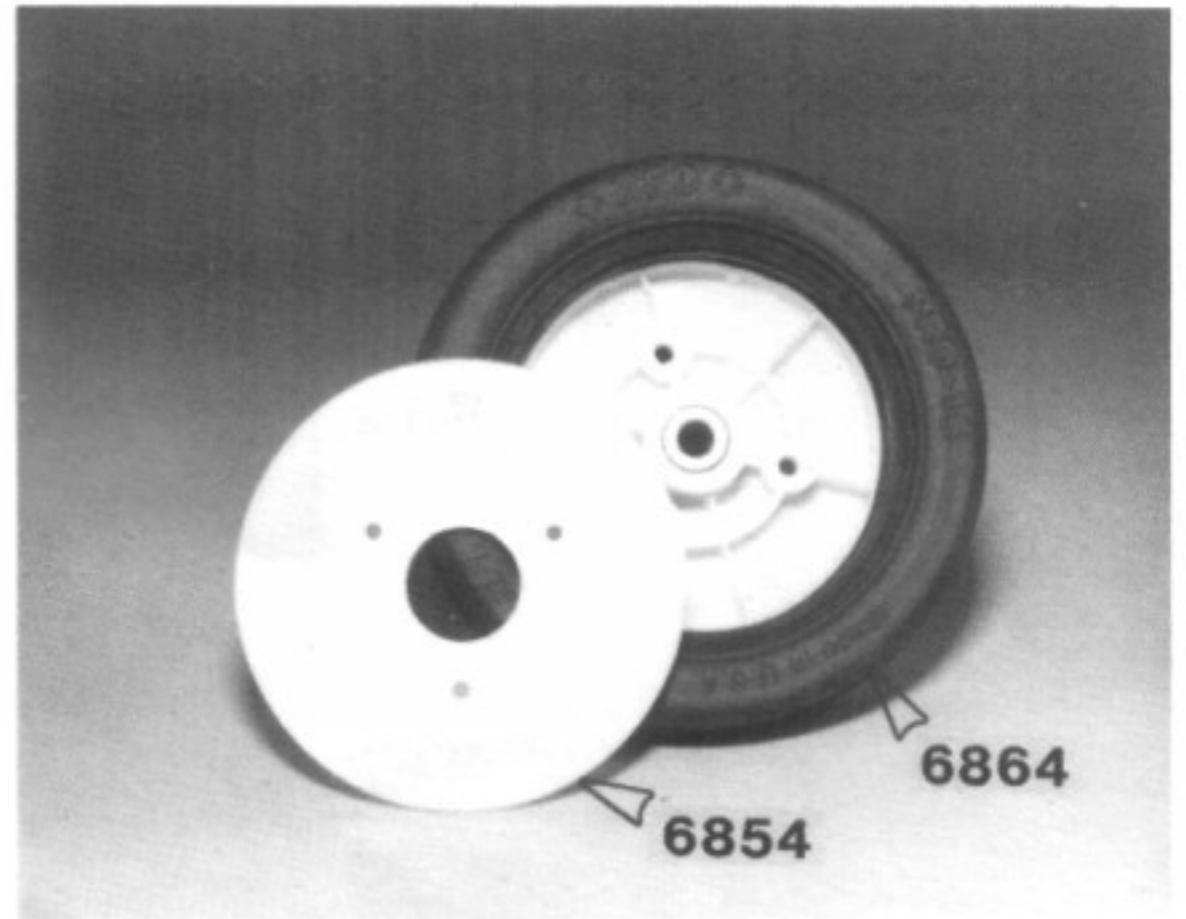

Fig. 192

□ **Fig. 191** The front tire, #6854, with the ring inside. Make sure it's perfectly centered.



Fig. 191

□ **Fig. 193** Turn the tire over and install the inside half of the wheel. Make sure the screw holes are in line.

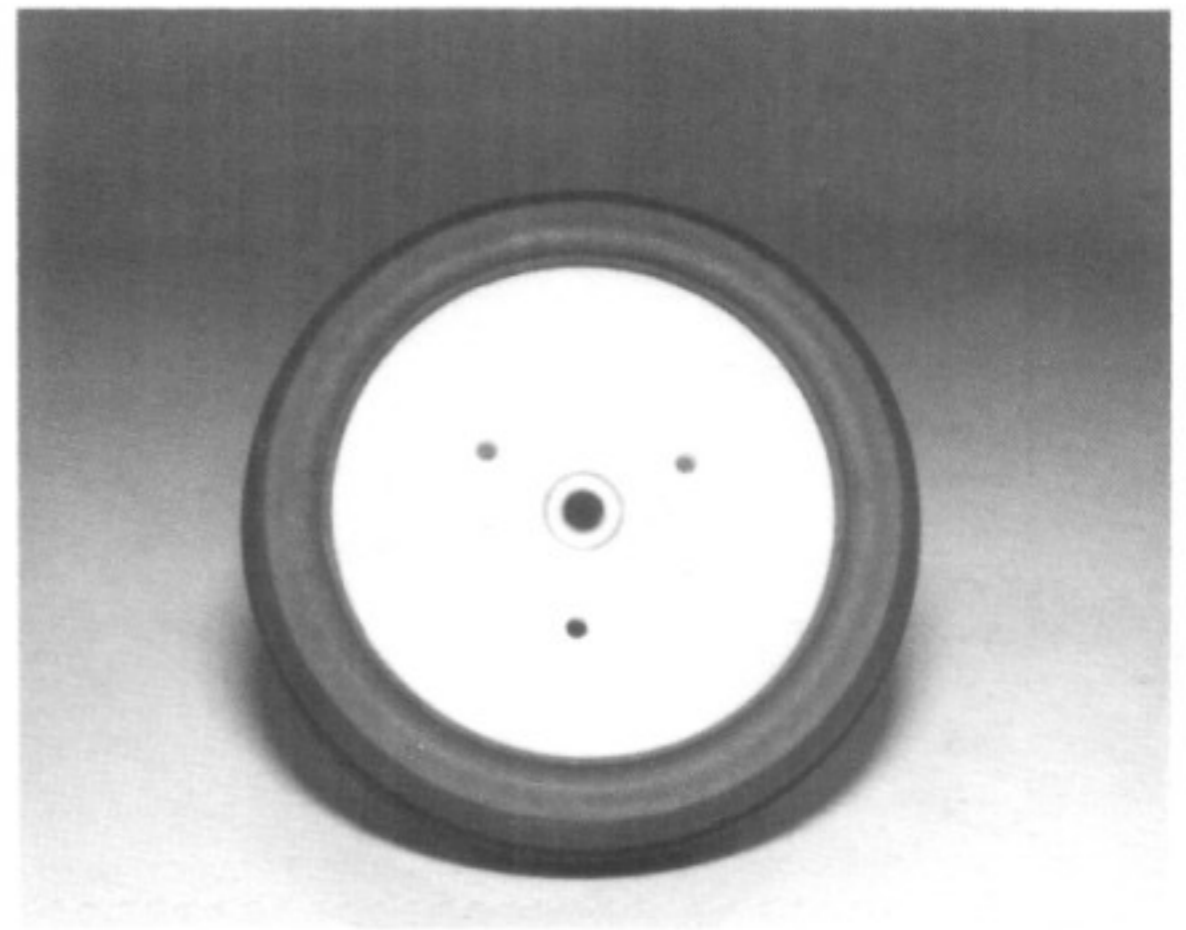

Fig. 193

Fig. 194 Install the 3 Allen screws. DO NOT over-tighten these screws. Install the inside and outside #6863 wheel bushings or ball bearings.

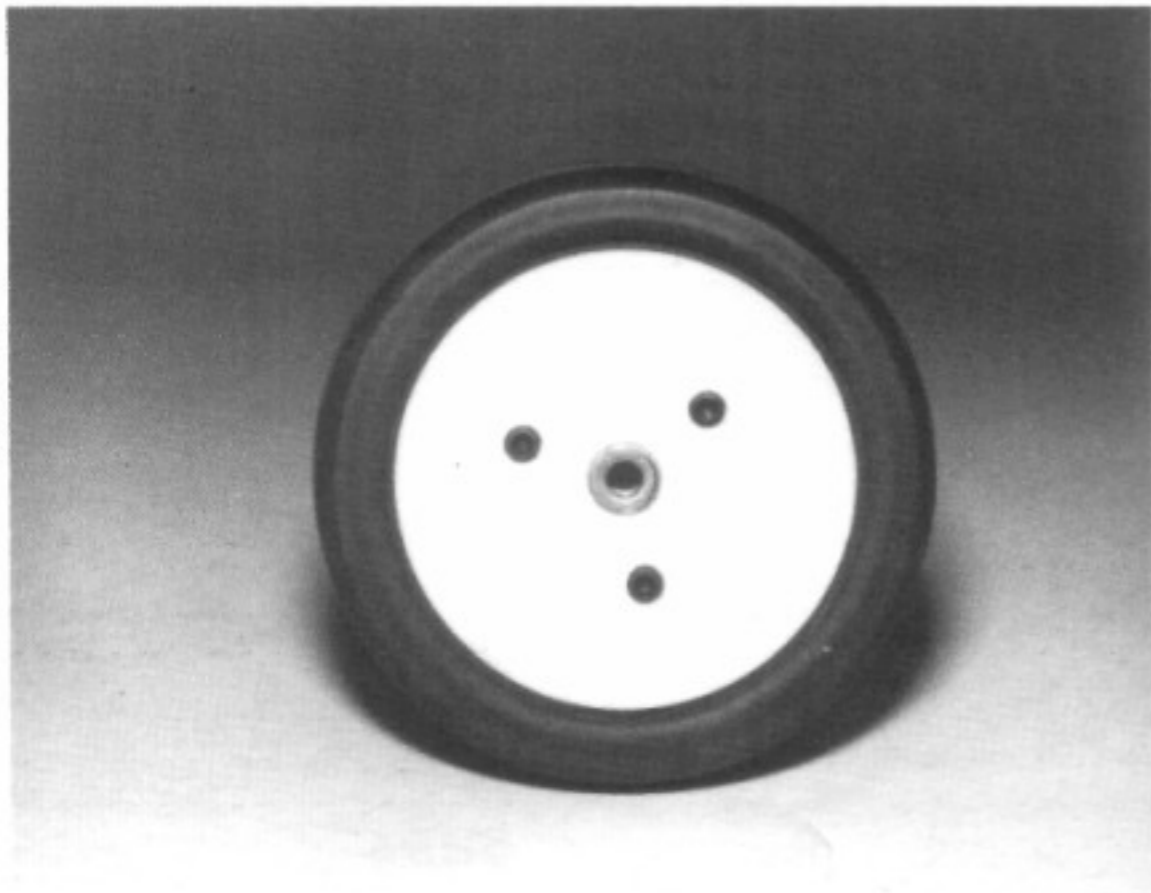

Fig. 194

Fig. 196 Take the rear tires, #6804 and slip the wide plastic rings inside the tires.

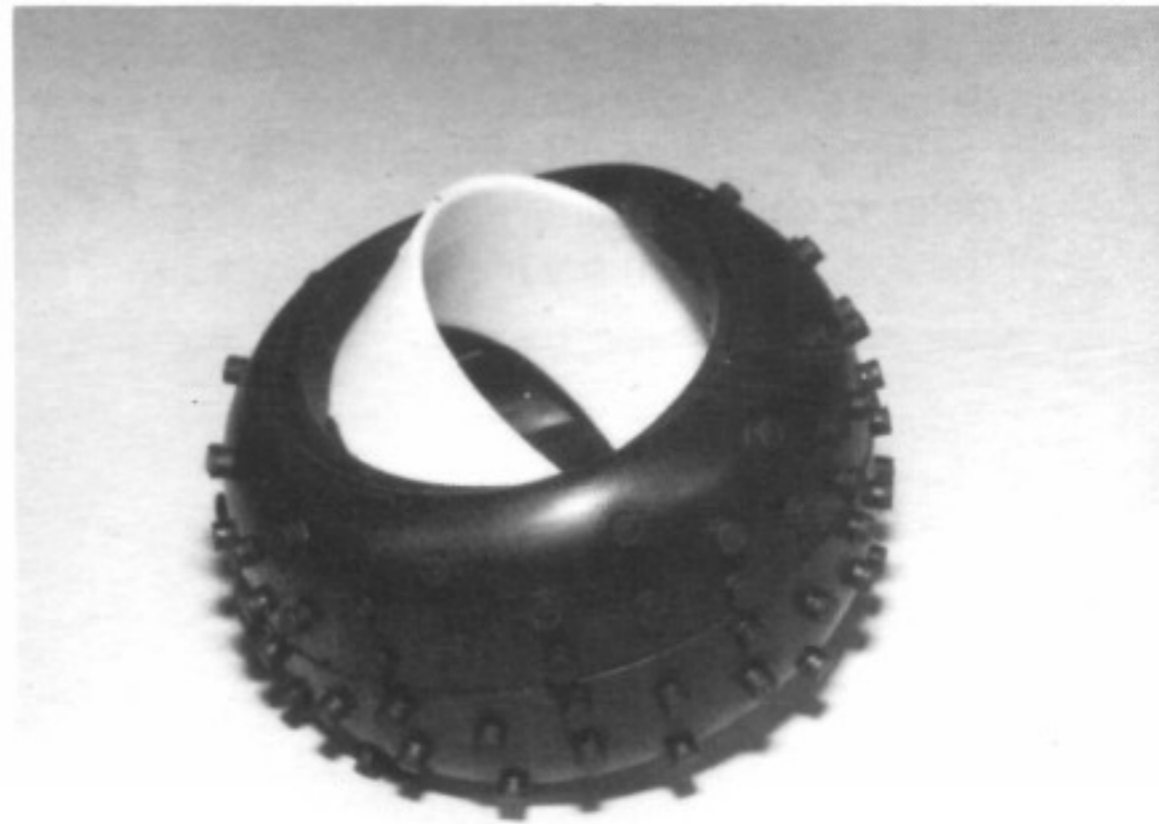

Fig. 196

Fig. 195 Oil the bushings and slip the wheels on the front axles. Spin the wheels. They should spin true. If not, re-mount the tires. Then install the steel flat washer and the locknut on each wheel.

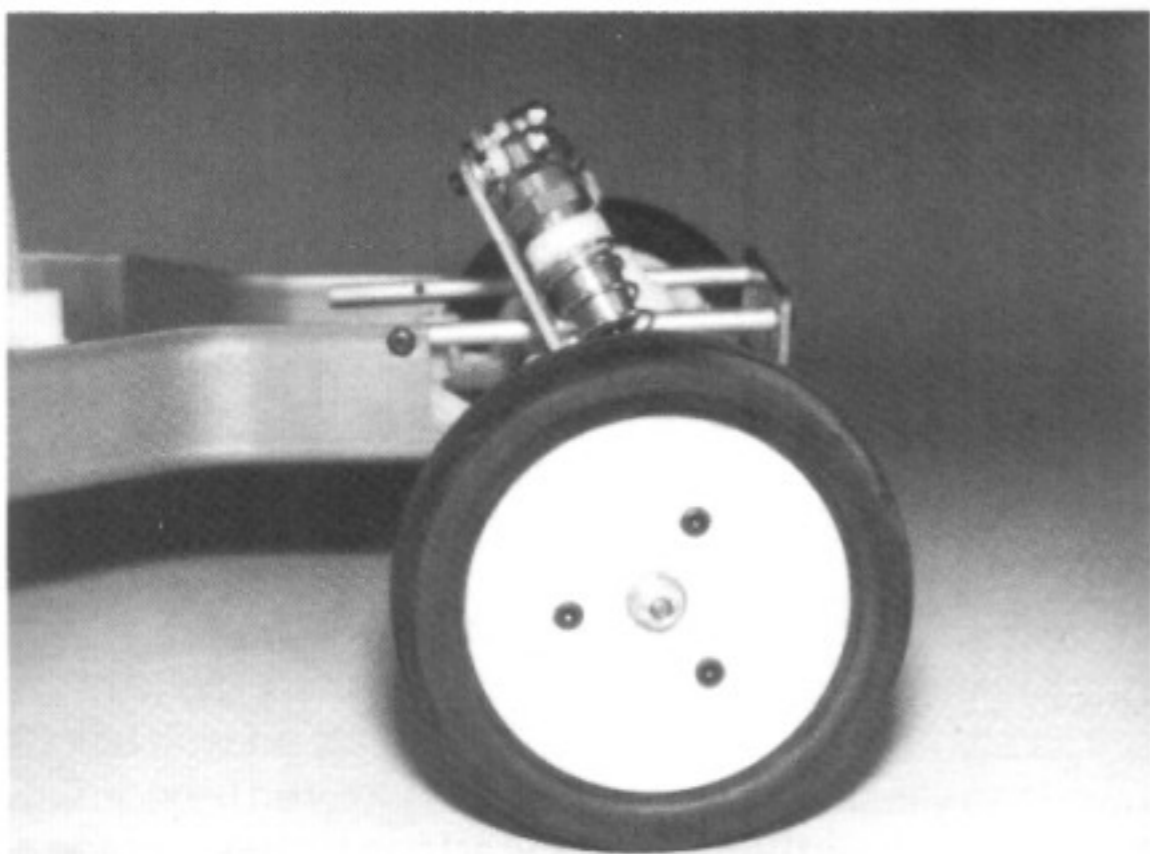

Fig. 195

Fig. 197 They then should look like this.

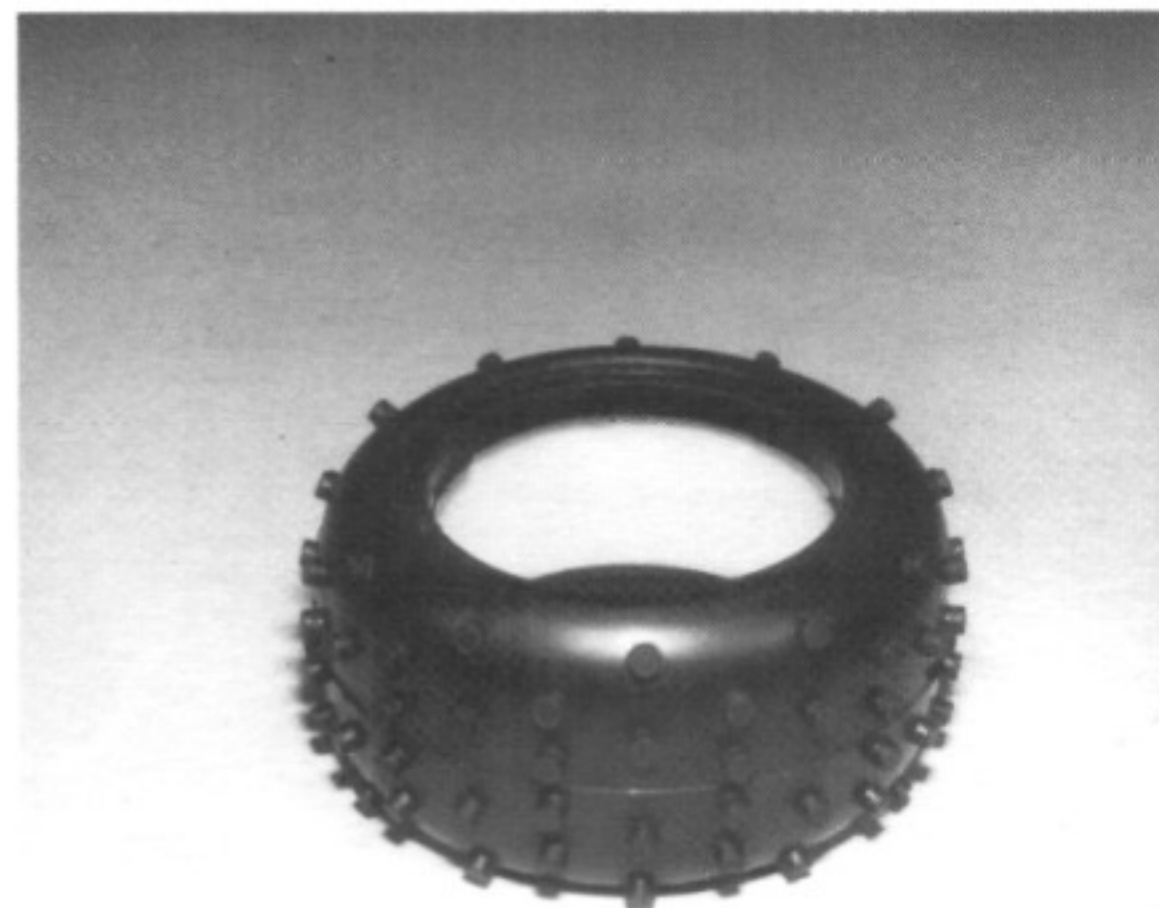

Fig. 197

□ **Fig. 198** Take the inside half of the wheel and slip it inside the inside side of the tire, as shown, and make sure it's fully seated and centered perfectly.



Fig. 198

□ **Fig. 199** Now take the outside half of the wheel and slip it inside the other side of the tire. Make sure the screw holes are lined up. Install the screws. Do not over-tighten.

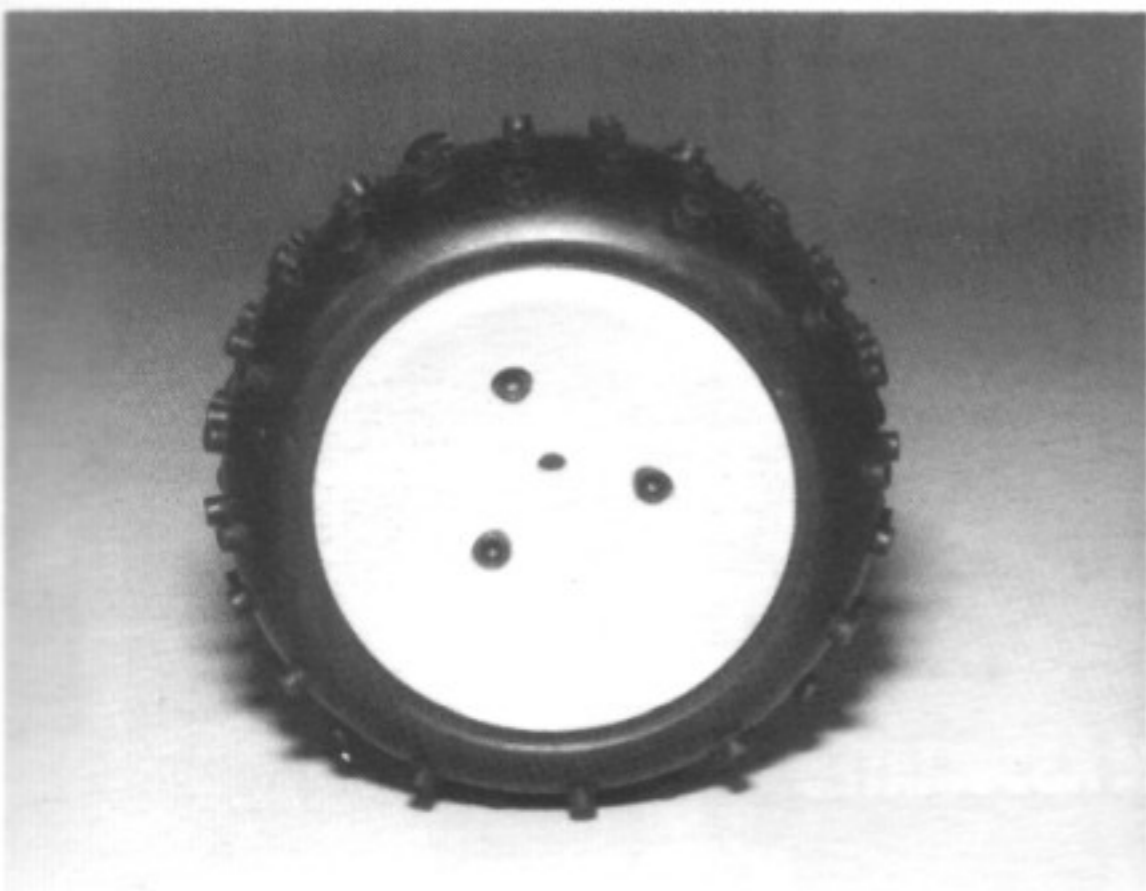

Fig. 199

□ **Fig. 200** Slip the wheels on the rear axles. If they go on tight, screw them on the axle making sure the slot in the wheel aligns with the pin in the axle. Screw the locknut on. Some rear wheels will go on the axles a little tighter than others. When you're ready to remove the wheel, remove the nut, hold the wheel from the backside and tap the end of the axle until the wheel moves a little bit. Then you can simply unscrew it off the axle. I know you can't wait to see if the car runs, so turn the transmitter on, hold the car up by the center of the chassis, with your hands away from the rear tires, and turn the switch on. Touch the throttle just a little way and see if the tires turn forward. If everything's O.K., go ahead and play with the car a little while, but be careful!

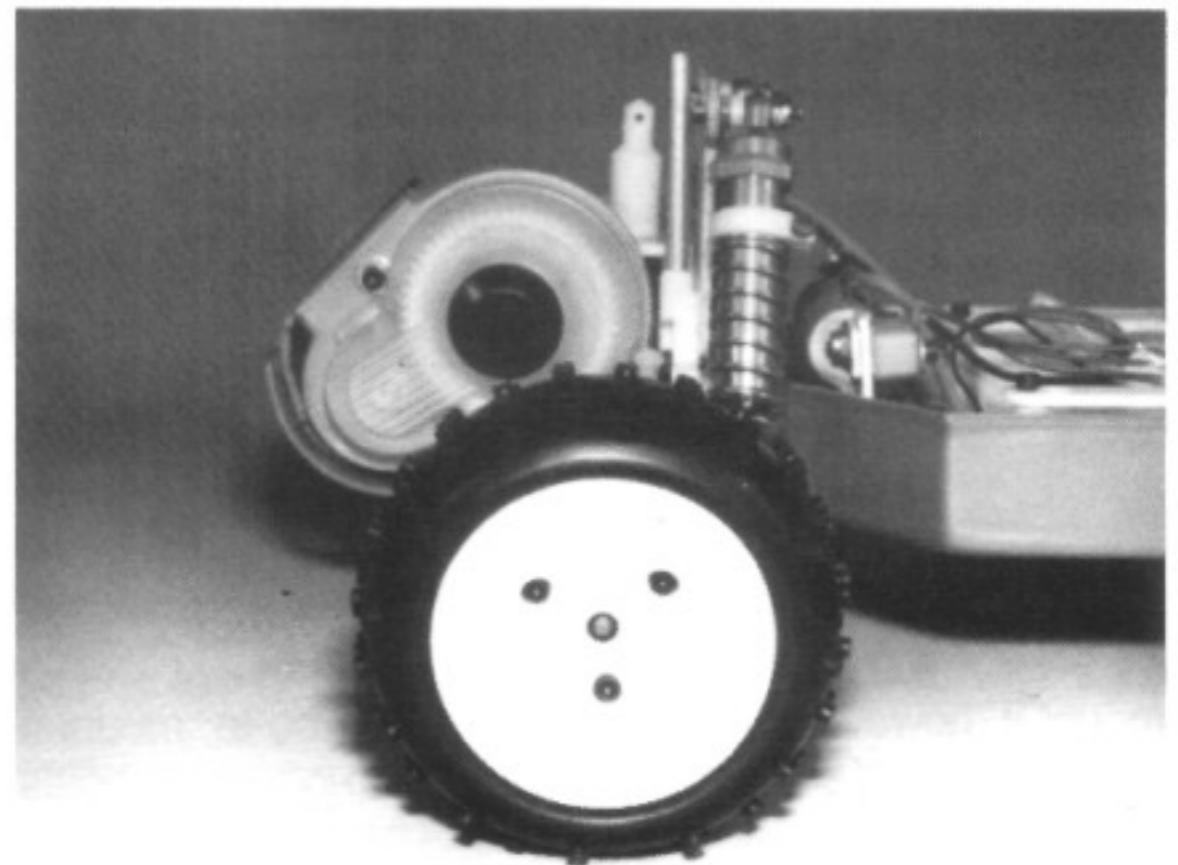

Fig. 200

□ **Fig. 201** The driver can be painted to look quite life-like. If you paint the helmet and visor on the inside, they will have a glossy appearance. Then if you paint the rest on the outside, it will be very life-like. You can use the small brush on paint bottles available in hobby stores. The driver should be trimmed as shown, then it will slide up into the body, and 2 pieces of tape will hold it in place.

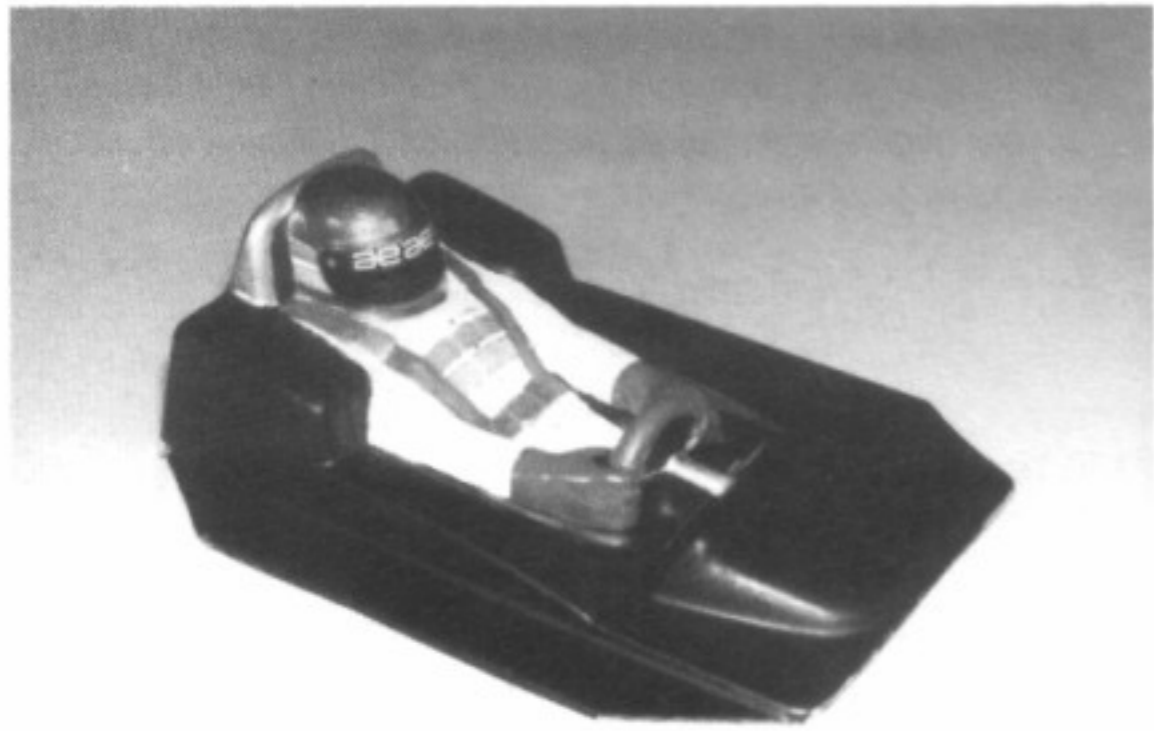

Fig. 201

Fig. 203 The rear of the body must be trimmed like this to clear the shocks.

NOTE: Save the trimmings to use for testing paint.

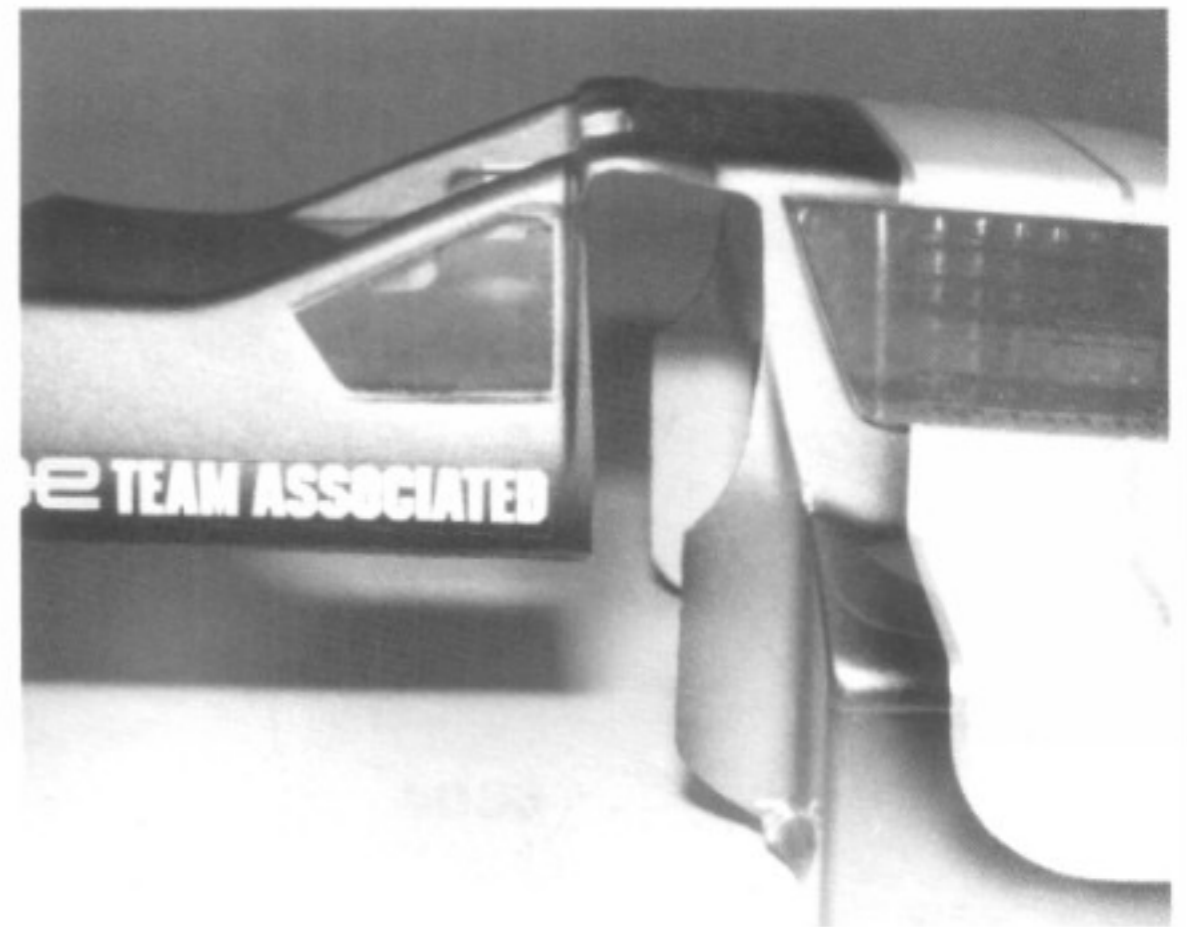

Fig. 203

Fig. 202 The body can be painted before you mount it, however it might be easier for you to mount it while it's clear because it will be easier to locate the holes for the body mounts and wing tubes. This photo shows the trim lines for the front of the body and the front body mount hole.

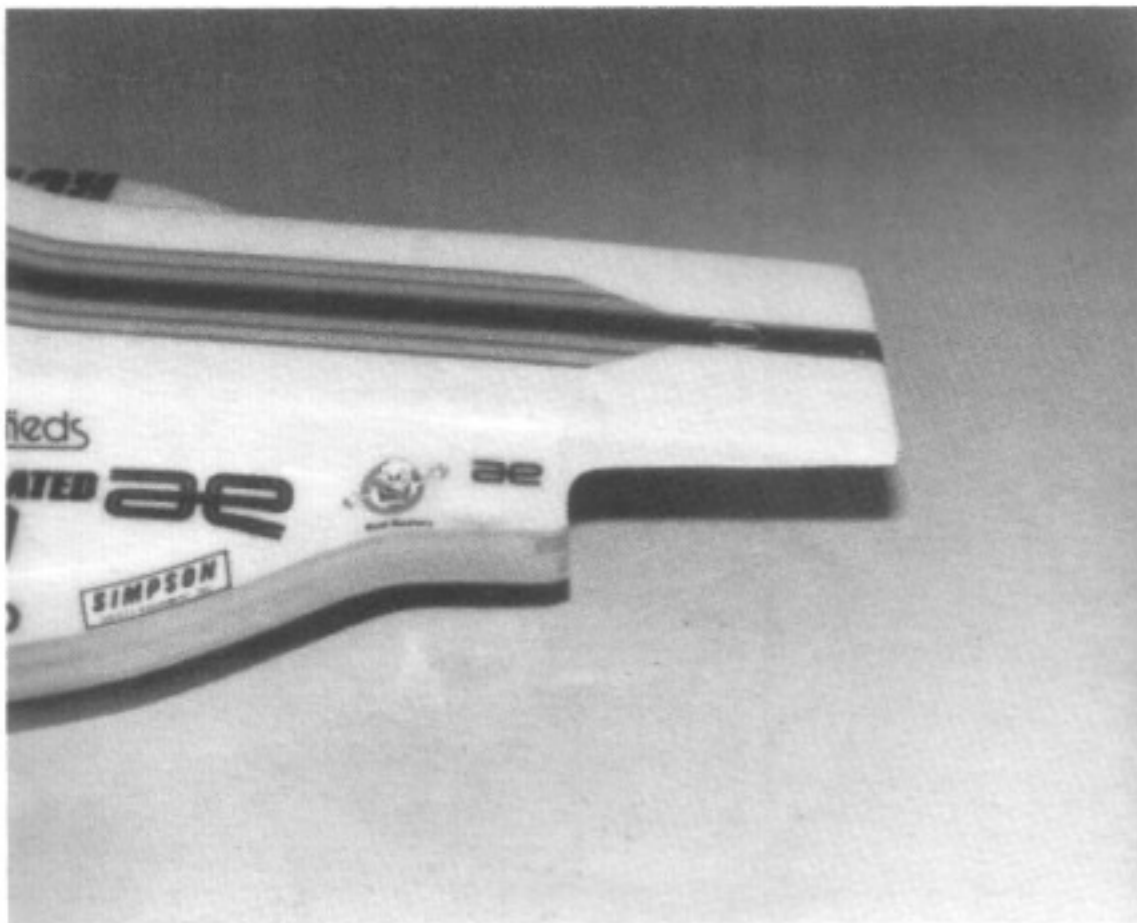

Fig. 202

Fig. 204 Trim a little of the body and slip it on. Keep trimming a little at a time until it clears the shocks. Cut out the body mount hole and the 2 wing tube holes. When you've got the body fitted, it's time to paint the body and wing. The body is painted on the inside and the wing is painted on the underside. There are 2 different ways to paint the body. By either brushing it on or spraying it on. The body is made of Lexan polycarbonate. In hobby shops, you can find special Lexan or polycarbonate paints made for these type bodies, to brush on. Do not use any other type brush-on paints. If you want to spray it on, one of the best type of spray paints for Lexan or polycarbonate is Pactra, available in most hobby shops.

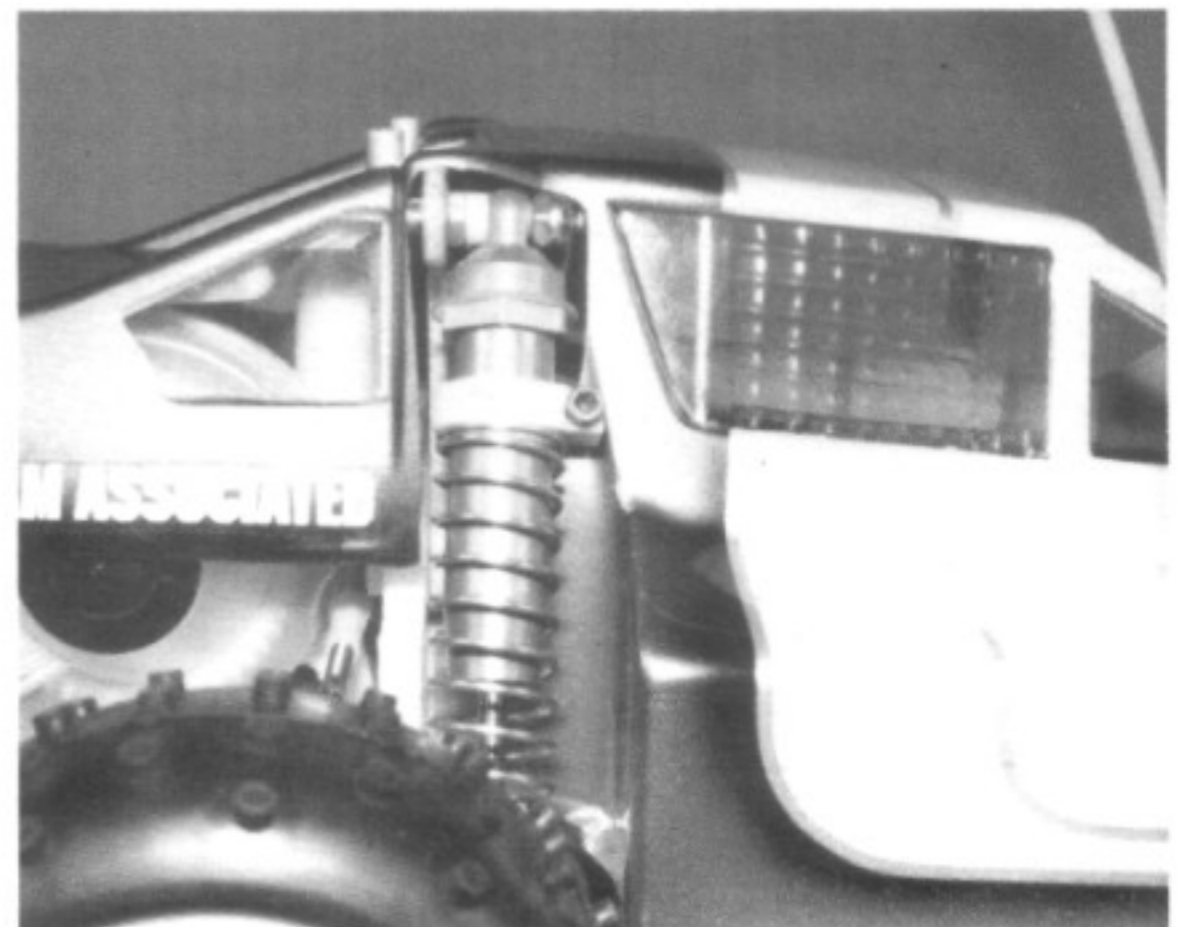

Fig. 204

5.1 / 5.2 2.55 / 2.6
 4.75 | 7.25 | 4.75
 14.5

Fig. 205 Now you'll have to figure out your paint scheme and mask the body off. Use automotive masking tape for best results. You always want to paint the darkest color first, and the lightest color last. So, in the case of this wing, the darkest color, which is towards the top of the photo, would be painted first. This means the first thing you mask off is the section which will be painted white. The next section you mask off is the lightest color next to white and so on. After you've painted the darkest color, you peel off the next layer of masking tape and paint the next lighter color and so on. When you paint the body, put some masking tape on the outside of the body at the body mount holes and wing tube holes and at the shock cutout holes so the excess spray does not get on the outside of the body.

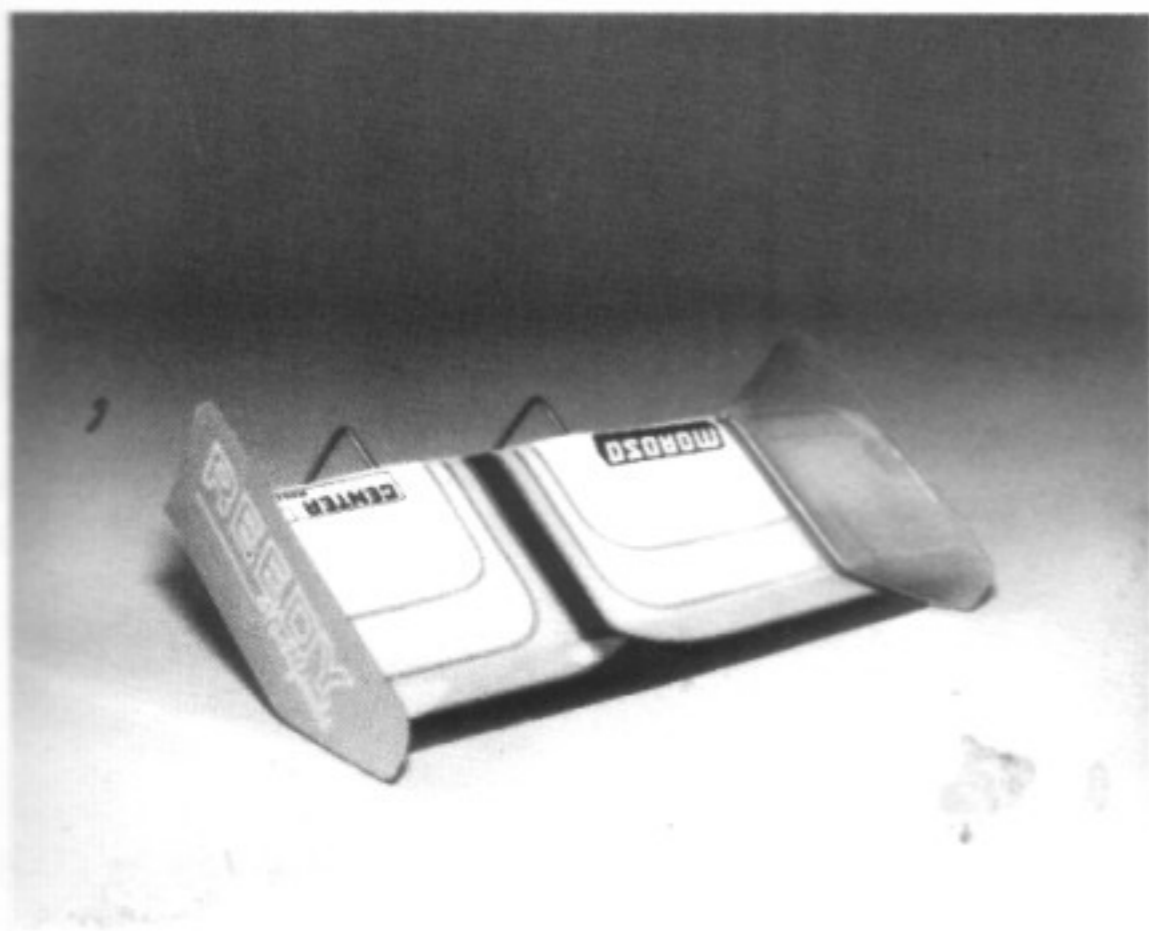

Fig. 205

Fig. 206 Mount the wing as shown in the instructions in the wing bag.

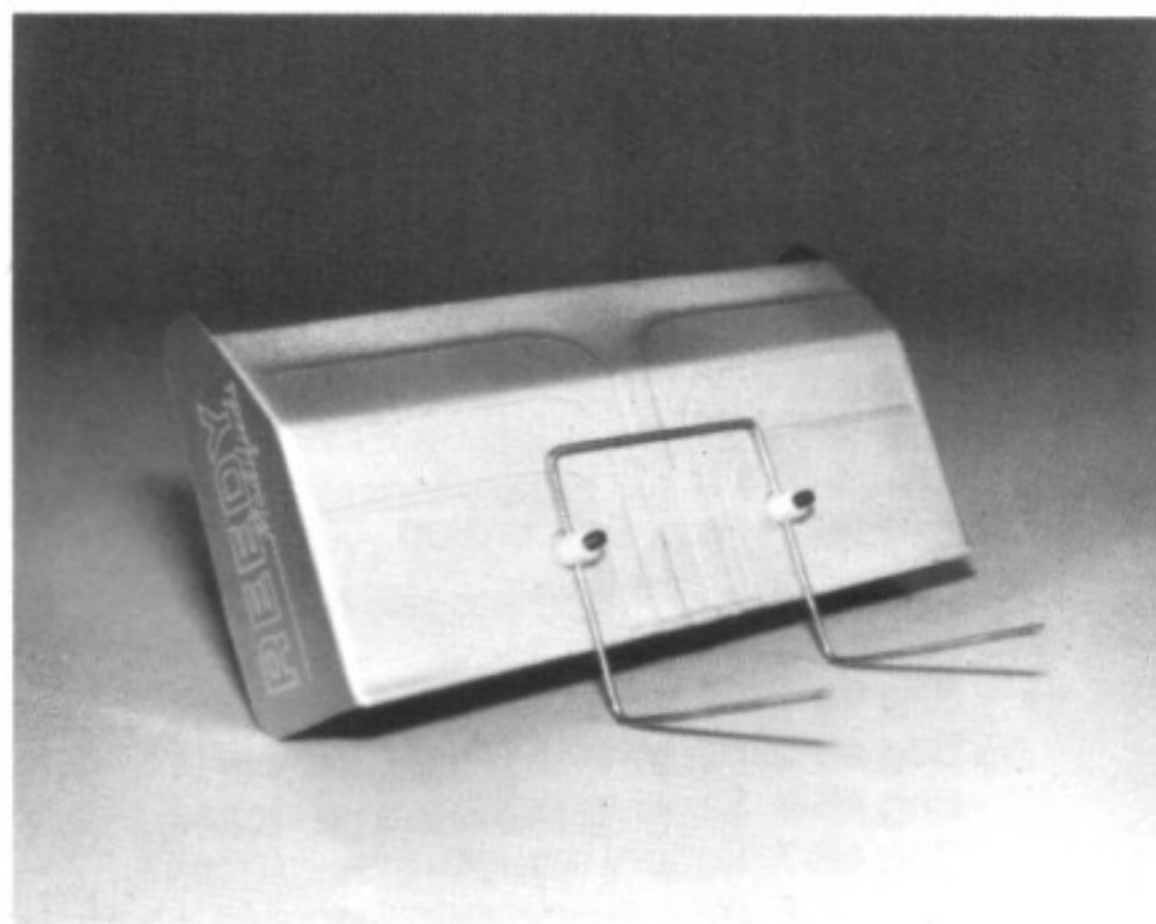

Fig. 206

Fig. 207 Mount the body, with the body clips and wing, on the car, and then pat yourself on the back. YOU DID FANTASTIC!!



Fig. 207

PARTS LIST

#6000 BASIC KIT contains the following:

- Chassis
- Rear wheels/tires
- Front wheels/tires
- Antenna kit
- Dif Lube
- Shock wrench/ball joint tool
- Headlamp set
- Knock-off set
- Bag #6-1 Front suspension
- Bag #6-2 Servo Saver

NO BAG #6-3 REQUIRED

- Bag #6-4 Chassis parts
- Bag #6-5 Body mounts
- Bag #6-6 Servo mounts
- Bag #6-7 Battery mounts
- Bag #6-8 Rear suspension
- Bag #6-9 Rear shocks
- Bag #6-10 Front shocks
- Bag #6-11 Springs and oil
- Bag #6-12 Transmission

NO BAG #6-13 REQUIRED

- Bag #6-14 Ball ends
- Bag #6-15 Gears

#6012 FULL KIT contains the following additional items:

- Motor
- Servo tape
- Wire ties
- Bag #6-13 Electrical items
- Bag #806 Charge cord

#6010 FULL KIT contains all of the above plus the following:

- Body
- Wing kit

#6016 FULL KIT is a #6010 kit with ball bearings

#6020 FULL KIT is a #6010 kit with a 6-cell ni-cad pack

RC10 KIT CONTENTS

BAG 6-1 - Front Suspension Bag

6206 Front A arms "wide track"	pr
6207 Front Suspension Mount	pr
6213 Front Block Carrier 15 deg	pr
6217 In line Axle Steering Blk	pr
6218 In line Front Axle	pr
6223 King Pin	pr
4-40 shcs special for front shock mounting	pr
6226 Inner Hinge Pin	
6227 Outer Hinge Pin	
6231 Front Shock Strut Wide "A" arms	
4-40 x 1 3/4 Turnbuckle	pr
6242 4-40 Nylon Insert Locknut	pr
3216 #4 Steel Washer	pr
6280 8-32 x 1/2 100 deg Alum Fthd	
Phillips Green	6
4-40 x 1/2 S.H.C.S.	2
6299 E Clips	16

BAG #6-2 - Servo Saver and Steering Linkage

6255 Servo Saver Plastic Only	
6256 Linkage	
Z Bend 1/16 Piano Wire	2
1/8 set screw Collar	2
4-40 x 1/8 Setscrew	2
4-40 x 2.06 Turnbuckle (Tie Rod)	2
4-40 x 1.00 Turnbuckle	1
6281 8-32 x 7/8 100deg Alum Fthd	
Phillips Green	2
8-32 Nylon Locknut	2
#10 Alum Washer	2

BAG #6-4 - Chassis Parts

6310 Nose Piece	
6320 Nose Brace Tubes	
6323 Rear Bulkhead	
6325 Transmission Brace	
6327 Wing Tubes	
6280 8-32 x 1/2 100deg Alum Fthd	
Phillips Green	2
8-32 x 1/4 100deg Steel	
F.H.P. Silver	1
6288 4-40 x 1/4 B.H.C.S.	4
4-40 x 1/2 S.H.C.S.	6
#4 Alum Washer	4

6378 Rear Shock Strut

BAG #6-5 - Body Mount Kit

6330 Plastic Body Mount Post	2
6332 Hood Pins	4
#10 Alum Washer	4
6280 8-32 x 1/2 100deg Alum	
F.H.P. Green	2
6281 8-32 x 7/8 100deg Alum	
F.H.P. Green	1

BAG #6-6 - Servo Mount Kit

6336 Servo Mount Plastic	4
6292 4-40 x 3/8 F.H.S.C.	4
4-40 x 5/16 B.H.C.S.	8
#4 Alum Washer	10

BAG #6-7 - Battery Cup

6334 Battery Cup	pr
6335 Battery Holddown Strap	2
6332 Hood Pins	4
4-40 x 1/2 F.H.S.C.	4
4-40 x 3/8 S.H.C.S. W/hole	2
4-40 x 3/8 S.H.C.S. Pln 2	

BAG #6-8 - Rear Suspension Kit

6355 Rear A Arms	pr
6360 Rear Suspension Mounts	pr
6366 3deg Rear Hub Carriers	2
6370 Rear Dogbones	2
6372 Dogbone Spring/Spacer	2
6374 Rear Stub Axle	2
6375 Stub Axle Roll Pin	2
6380 Rear Inner Hinge Pins	pr
6381 Rear Outer Hinge Pins	pr
4-40 x 1 3/4 Turnbuckles	2
6387 Bronze Oilite Bushing/w	
Washer	pr
6388 Cone Washer	pr
6280 8-32 x 1/2 100 deg Alum	
Flathead	4
4-40 x 5/16 S.H.C.S.	4
6299 E Clip	16
8-32 Nylon Insert Alum	
Locknut	2

BAG #6-9 - Rear Shock Bag

6452 Rear Shock Body .4x132	2
6463 End Cap	2
6458 Shock Shaft 1.32 Stroke	2
6464 Piston	2
6467 Rebuilt Kit ("O" ring	
washer bag) #6468 Nylon	
Gasket	2
Nylon Spacer	2
Large Washer	2
Small Washer	2
Snap Ring	4
50 Shore Silicone "O"	
Ring	4
#6299 E Clips	8
6470 Mounting Kit Includes	
6471 Rod Ends w/.230 Balls	
6473 Cap Bushings	2
4-40 x 3/4 S.H.C.S.	4
4-40 Plain Hex Nut	4
4-40 Nylon Insert Locknut	4
#4 Alum Washer	4
Nylon Spacers	6

BAG #6-10 - Front Shock Bag

6454 Shock Body .71 Stroke	2
6463 End Cap	2
6460 Shock Shaft .71 Stroke	2
6464 Piston	2
6467 Rebuild Kit (See Bag 6-9)	
6470 Mounting Kit (See Bag 6-9)	
Nylon Spacers	

BAG #6-11 - Oil, Springs, Clamps

5414 30 wt Shock Oil	
6478 Spring Rear 2.75 x .042	
Silver	2
6479 Spring Rear 2.75 x .045	
Gold	2
6496 Spring Front 1.3 x .042	
Silver	2
6497 Spring Front 1.3 x .045	
Gold	2
6474 Clamps and Cups includes	
Spring Clamp	4
Spring Cup	4
4-40 x 3/8 S.H.C.S.	4

BAG #6-12 - Transmission Bag

6605 Gear Case Housing	
------------------------	--

6606 Bearing Adapters	
6607 Motor Mount Plate	
6608 Dust Cover w/Plastic Plug	
6609 Drive Gear Pivot w/Nut, Roll Pin	
6610 Idler Gear Pivot w/washer, clip #6635	
6611 Spine Plate	
6612 Axle Drive Gear	
6614 Idler Gears w/0-80 x 3/16 S.H.C.S.	10
6617 Dif Tube	
6618 Dif Shaft w/6620	
6621 Dif Pinion Right goes w/6617	
6623 Teflon Bushings	
6624 Dif Outer Hub	
6625 Dif Drive Rings	
6626 1/8 Grade 25 Chrome Steel Balls	8
6627 Thrust Bearing Set includes Thrust Washers w/small hole Thrust Washers w/large hole 1/8 Thrust Bearing	
6628 Dif Spring	
6629 5-40 Locknut	
6630 Oilite Bushing Set includes 3/16 x 5/16 Short	3
3/16 x 5/16 Long	2
1/4 x 3/8 Thin	1
6633 Felt Seal Retainer w/Seals	
6280 8-32 x 1/2 100deg Alum F.H.P.	4
4-40 x 1 S.H.C.S.	3
4-40 x 5/8 S.H.C.S.	1
4-40 X 3/16 B.H.C.S.	2
6285 4-40 x 1/4 S.H.C.S.	2
6299 E Clips	12
Snap Rings	4
Small Pattern 4-40 Nut	1
BAG #6-13 - Electrical Bag	
6711 Resistor	
6712 Wiper Arm	
6713 Resistor Mounting Brkt incl. Straight Bracket	1
"L" Bracket	2
6714 Bypass includes Bronze Bypass	1
Nylon Mounting Block	1
3" Wire	1
4-40 x 3/8 S.H.C.S.	1
4-40 x 1/2 S.H.C.S.	1
2 #4 Alum Washer	1
6744 Wire Harness Input	
6745 Wire Harness Output	
Misc Hardware includes Yellow Bypass	

4 Nylon Spacers	
#2 x 1/4 Panhead Screw	2
4-40 x 1/2 F.H.S.C.	2
4-40 x 3/8 F.H.S.C.	2
4-40 Nylon Insert Locknt	4
#2 Washers	2
BAG #6-14 - Ball End W/Cups	
6273 Ball End Long	6
6270 Ball End Short	8
4-40 Plain Hex Nut	8
6274 Plastic Ball Cup	14
BAG #6-15 - Gear Bag	
6653 54T Gear Spur	
6660 14Tooth Pinion Gear 4-40 x 1/8 S.S.	
6955 Turnbuckle Shock Wrench	
6191 Headlights & Knockoffs	
6338 Antenna Mount and Tube	
6636 Dif Lube	
6950 Allen Wrench Set Wire Ties 4"	
3714 Servo Tape	
6500 Stock Motor w/Leads	
6300 Chassis	
6173 Protech II Body	
6182 High Down force Wing Kit	
6180 Clear Driver	
REAR WHEEL	
6804 3 pc Low Profile Rim	2
Rear Tire	2
4-40 x 3/8 S.H.C.S.	6
FRONT WHEEL	
6854 3 pc Low Profile Rim	
Front Tires	
3/16 x 3/8 Bushing Bronze	
Oilite	4
4-40 x 3/8 S.H.C.S.	6

RC10 WIRING DIAGRAM

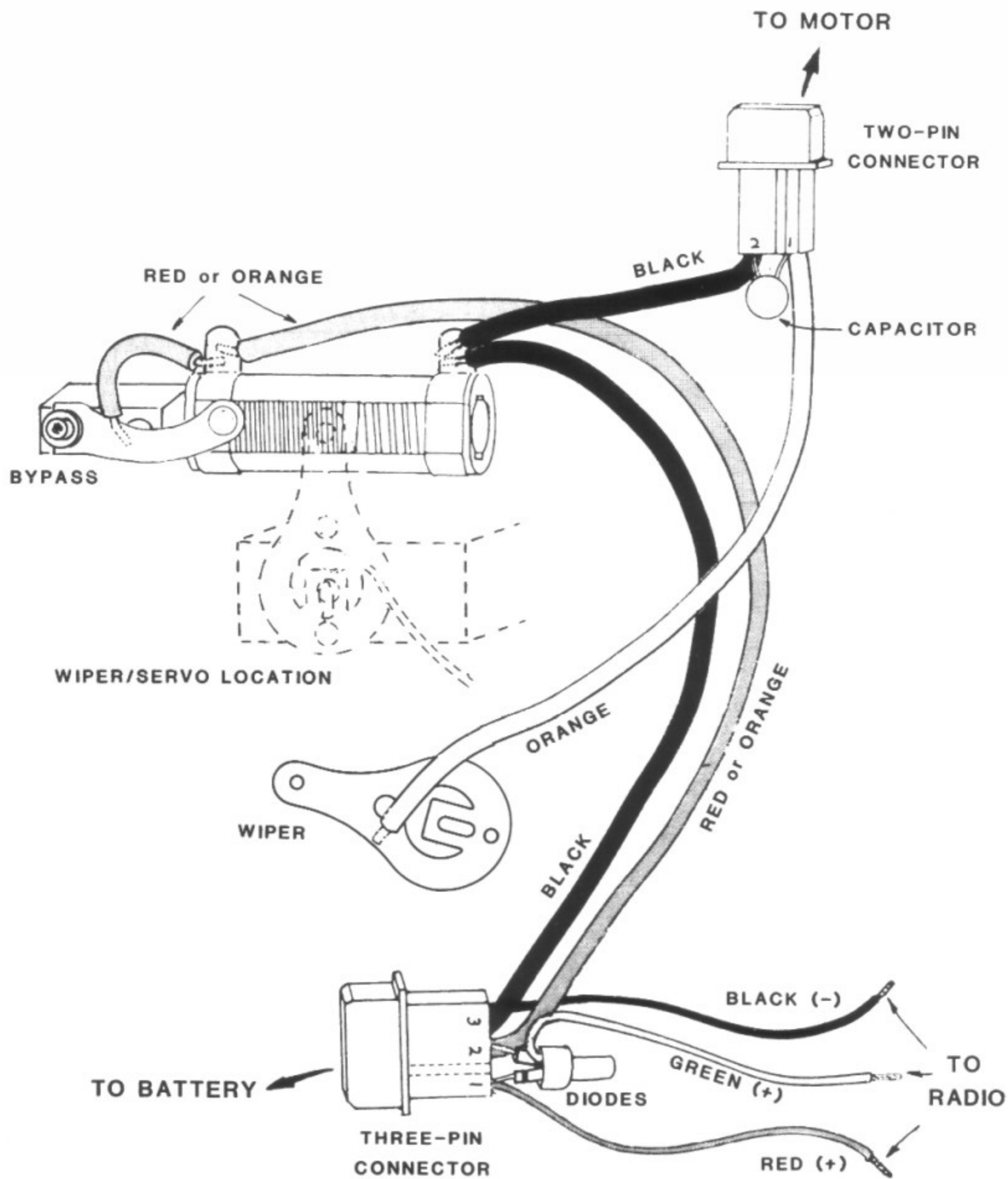

NOTE: Use green and black radio leads with 6-cell pack. Use red and black radio leads with 7-cell pack.

Fig. 208

BATTERY WIRING

STEP 1

Join cell sticks with servo tape.

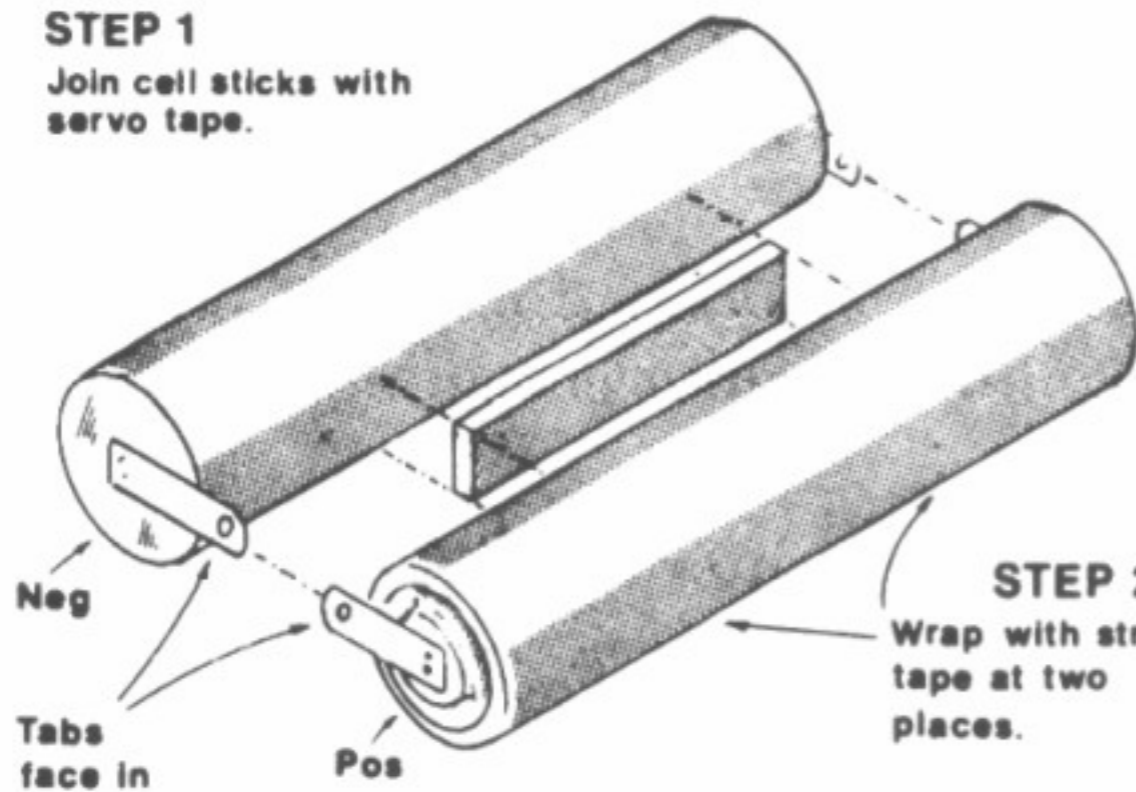

STEP 3

Join and solder tabs at one end of pack.

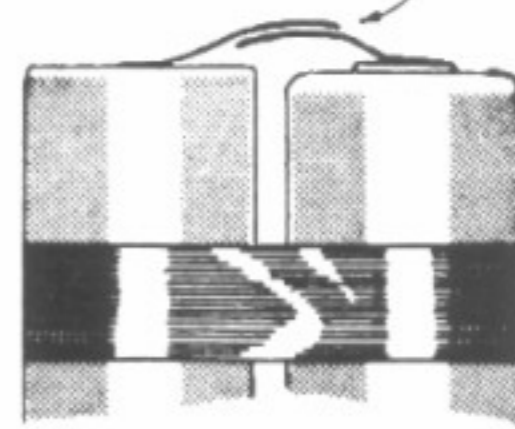

STEP 2

Wrap with strapping tape at two places.

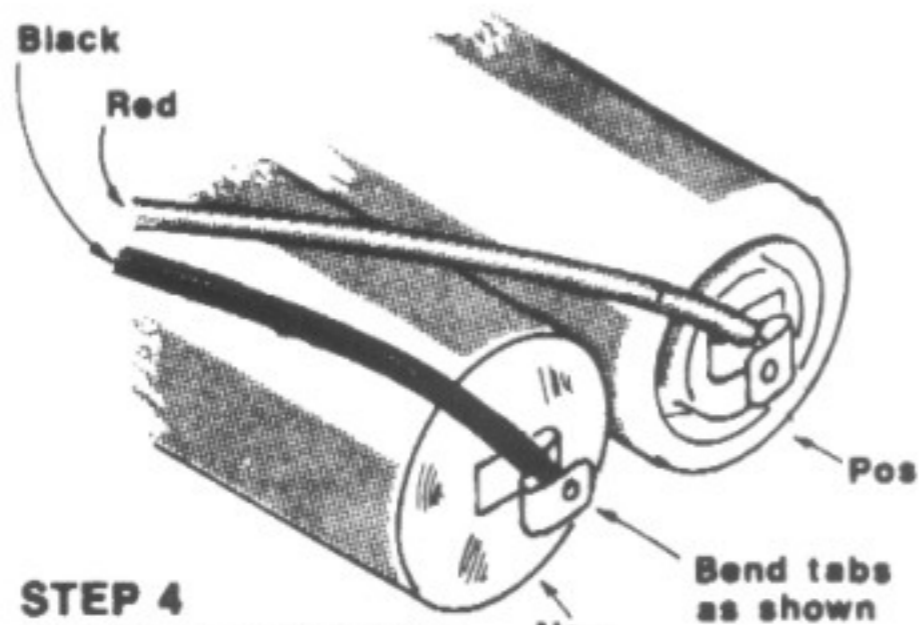

STEP 4

Solder connector wires to tabs at other end.

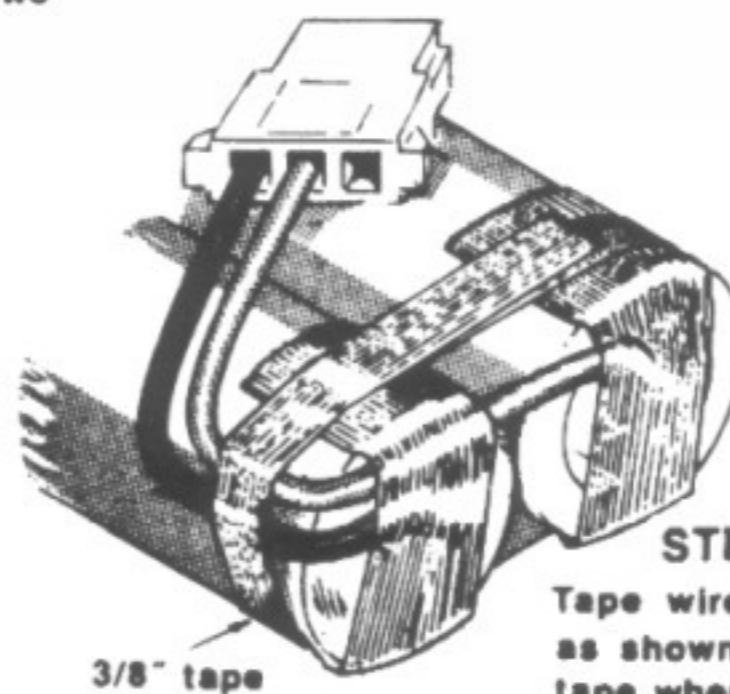

STEP 5

Tape wires to pack as shown. Use 3/8" tape where indicated.

Fig. 209

RC10 CIRCUIT SCHEMATIC

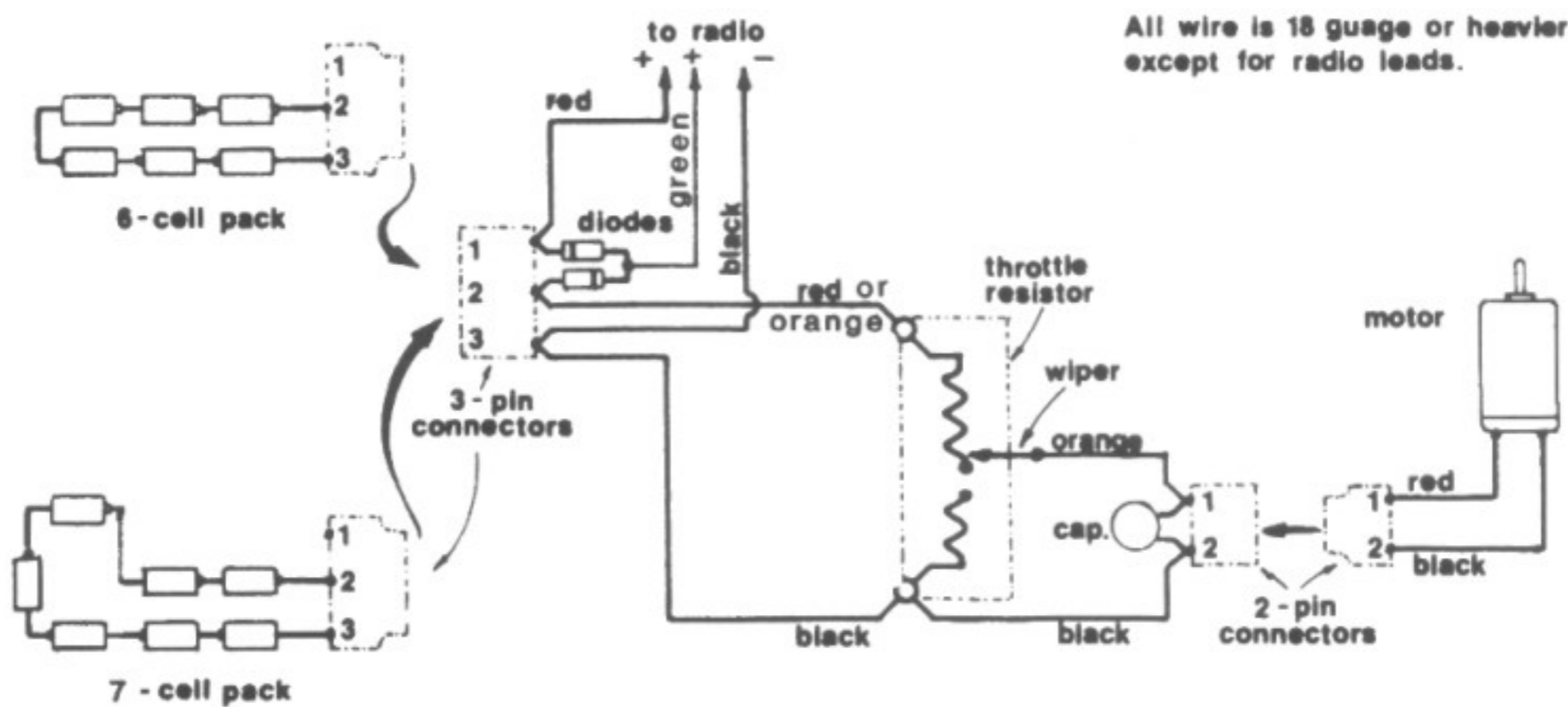

Fig. 210

SAVE THIS BOOKLET!!

MORE THAN AN INSTRUCTION MANUAL, IT'S ALSO A HANDY, PICTORIAL SUPPLEMENT TO TEAM ASSOCIATED'S 1/10 SCALE CATALOG.

REFER TO THIS MANUAL FOR PART NUMBER AND NAME WHEN ORDERING.



wishes you high-performance racing!

REEDY *Modifieds*

(Graph shown represents actual computer readout of Reedy Modifieds motor.)

**Reedy Modifieds Are
Bursting Through
With New Technology**

Reedy Modifieds uses advanced R & D computer systems to develop and improve motor performance. Race developed and tested, Reedy motors are 7 TIMES IFMAR WORLD CHAMPIONS, leaping ahead of all competition.

**Reedy Modifieds.
The Outburst of
New Technology.**



3585 Cadillac Ave.
Costa Mesa, CA 92626 USA

Phone (714) 850-9342 Telex 756887

FAX 714-850-1744

CURRENT

TORQUE

POWER OUTPUT

OVERALL EFFICIENCY



RC10 CHAMPIONSHIP EDITION

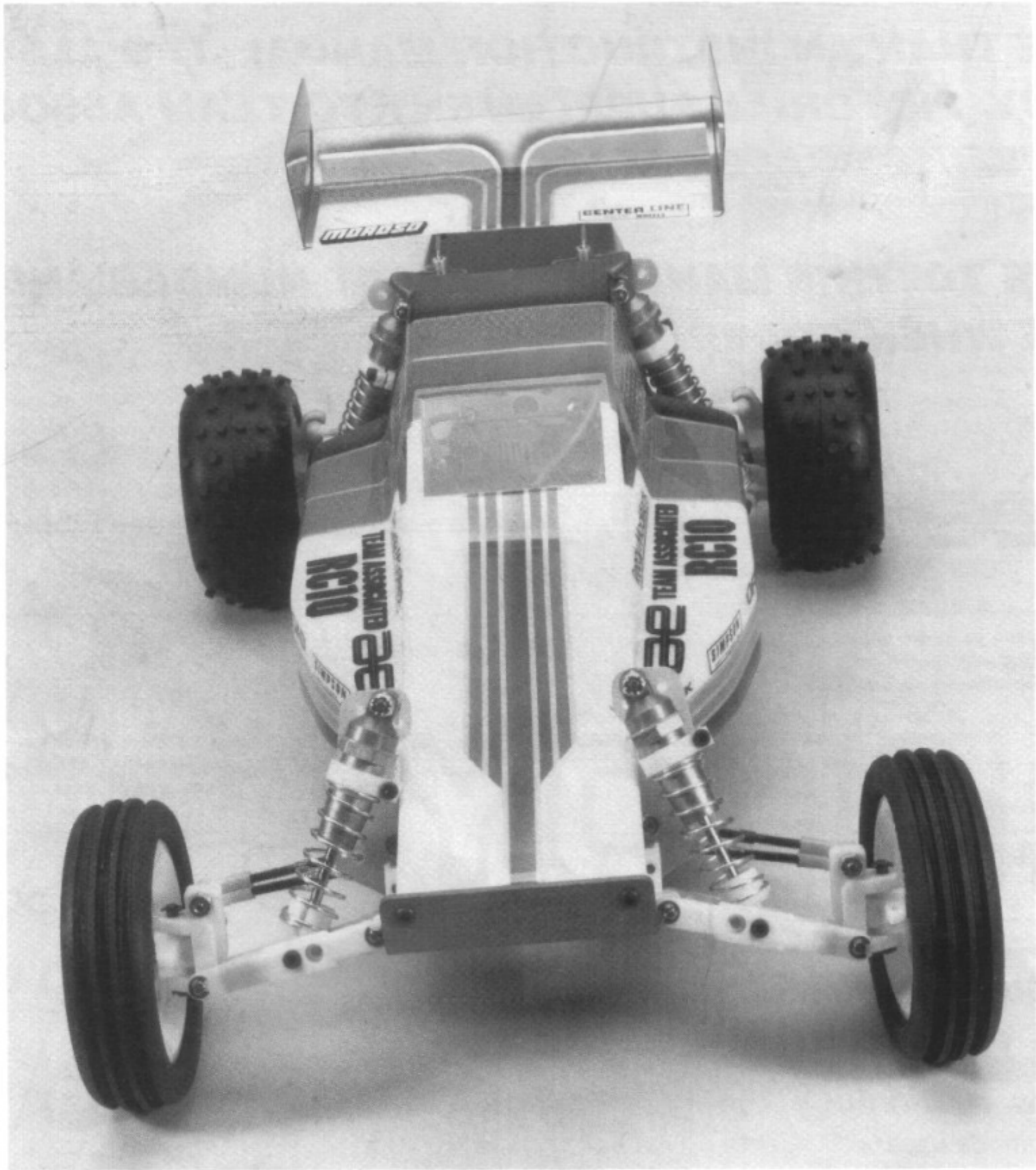

TEAM ASSOCIATED

Associated Electrics, Inc.
3585 Cadillac Ave.
Costa Mesa, CA 92626 USA



ec.
AE